

Consideration of Impact Behavior for Radioactive Package onto Real Targets

K. SHIRAI, H. AKAMATSU

Central Research Institute of Electric Power Industry, Tokyo, Japan

M. FUNAHASHI

Maeda Corporation, Tokyo, Japan

1. OBJECTIVE

According to the IAEA Regulations for the Safe Transport of Radioactive Materials, 9m drop test are required to type B package as the test condition which simulated accidents in transport, e. g. fall, clash of the package¹⁾. The target provided for this drop test is unyielding surface, therefore all kinetic energy of the dropping package just before the impact is absorbed by the deformation of the package.

On the other hand, in case of real accidents, the targets are yielding surfaces, e. g. clay, sand, asphalt, concrete, water, so that a part of the kinetic energy of the dropping package just before the impact is absorbed by the deformation of the targets. Consequently, it is expected that the behaviors of the package impacted on the various targets are different from each other on account of the difference of targets.

In this study, drop tests are performed by using small test samples made by steel and targets with various rigidity in order to clarify the relation between the difference of the target and the behavior of the package.

2. DROP TEST

(1) TEST EQUIPMENT

Figure 1 shows the concept of test equipment.

The target was composed of sand or water filled up in the acrylic case about 70 cm depth.

In the case of sand target, sand surface was made hard to stab by using a pole each 10 cm depth.

And after each drop test, sand surface was dug up and stabbed to make hard because the uniformity of the sand was disturbed in the cause of the drop impact.

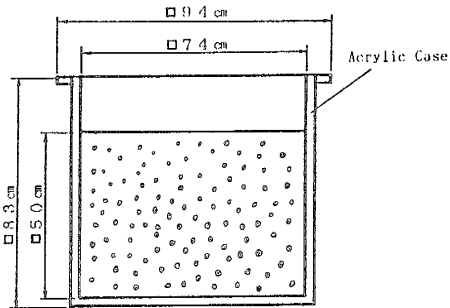
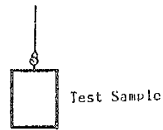
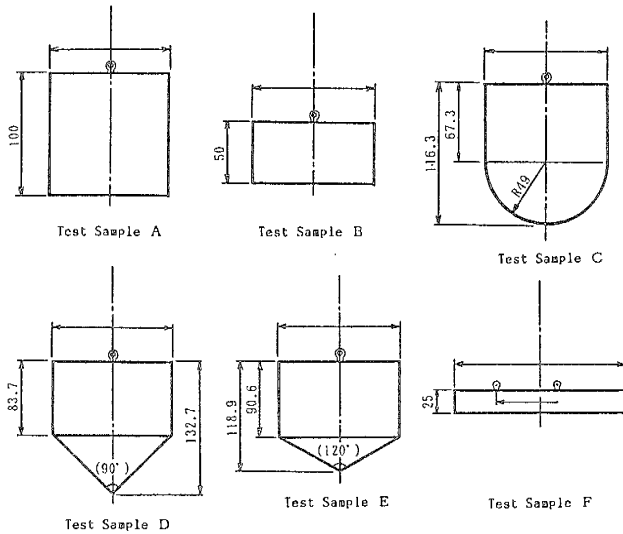

Figure 1 Test Equipment

(2) DROP TEST

Figure 2 shows the test samples used for drop tests.
 Test sample A was appropriate for both vertical and horizontal drop tests.
 The outline of the test condition is as follows:

- Sample : Cylinder (A), Cylinder (B), Hemisphere (C), Cone (D),
 Cone (E), Disk (F)
- Weight : Cylinder (B) 3kg; Others 6kg
- Target : Sand, Water
- Height : 0.15m ~ 2.4m
- Measured Item : G value



Unit : mm

Figure 2 Test Samples

3. THE RELATION BETWEEN G VALUE AND DROP HEIGHT

The results of drop test shows that G values measured on the test samples increase according as the drop height (H) and the ratio of the projected area (A) and the weight (W) of the test sample. According to these point of view, the relation between G value and drop height in case of the drop test on the sand target and water target is studied.

The equation estimating G value is defined with H and A/W as follows;

$$G = a \times H^b \times (A/W)^c \quad (1)$$

H : drop height (m)
 A : projected area (m²)
 W : weight of the test sample (kg)

(a) Sand target

In case of the drop on the sand target, the shape of the test sample tip is seemed to influence the G value.

According to the CRIEPI study, the influence (shape factor) was as follows;

- flatness : 1.0
- roundness : 0.86
- sphere : 0.72
- cone : 0.63

G value obtained through drop tests is corrected using these shape factor.

Using the least squares method, the regression equation (2) is set up through substitution the 83 corrected datas on the sand target for equation (1).

$$G = 1439 \times H^{0.512} \times (A/W)^{0.504} \quad (2)$$

Test results and the regression equation are shown in figure 3. In this figure, vertical axis is G value, horizontal axis is $H^{0.512} \times (A/W)^{0.504}$. The regression equation agree well with the test results, so that the regression equation shows the test results with enough accuracy.

(b) Water target

In case of the drop on the water surface, the relation between G value and drop height is studied by same method of sand target. Using the least squares method, the regression equation is set up through substitution the 103 corrected datas on the water target for equation (1). The regression equation is as follows;

$$G = 7762 \times H^{0.501} \times (A/W)^{0.982} \quad (3)$$

Test results and the regression equation are shown in figure 4. In this figure, vertical axis is G value, horizontal axis is $H^{0.501} \times (A/W)^{0.982}$. The regression equation agree well with the test results, so that the regression equation shows the test results with enough accuracy.

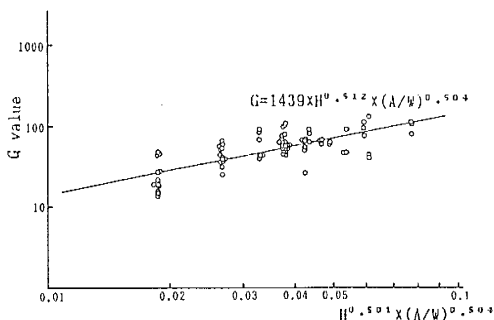

Figure 3 G value of drop test (sand target)

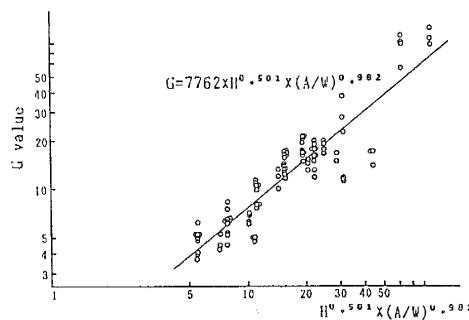

Figure 4 G value of drop test (water target)

4. DROP OF THE RADIOACTIVE PACKAGE ONTO REAL TARGETS

(1) Estimation from the regression equation

In case of sand and water targets, the relation between G value and drop height of 48Y cylinder it is the package used to transport natural uranium hexafluoride (figure 5) is obtained from the regression equation (2),(3). Figure 6 shows the results.

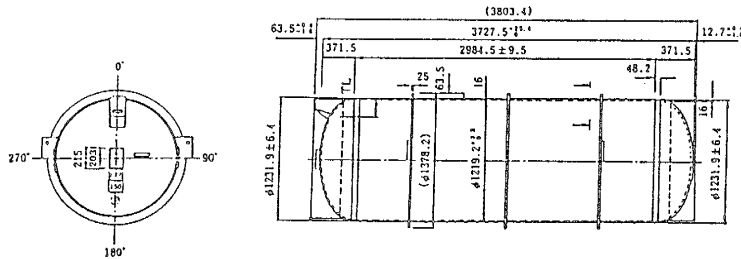

Figure 5 48Y Cylinder

(2) Estimation from drop analysis

The relation between G value and drop height of 48Y Cylinder onto real targets is obtained through drop analysis using spring-mass model. Spring-mass model used drop analysis is shown in figure 7. 48Y cylinder is modeled one mass.

It is assumed that the target is elastic infinity ground, and the target is modeled a number of masses because the interpenetration phenomenon of the cylinder ring and body in the target is expressed.

In case of unyielding, concrete, sand target, the relations between maximum G value and drop height which obtained spring-mass analysis are shown in figure 6.

(3) Drop test of 48Y Cylinder

In the study of Japanese utility "Study of safety during the transportation of natural uranium-hexafluoride", drop test of 48Y cylinder was performed in consideration of drop accident.

Target was made with sand which was charged in the steel enclosure, this target simulated the real target.

The test condition is as follows:

Package : 48Y Cylinder
 Weight : 15000kg
 Target : unyielding, sand
 Drop height : 9m (unyielding target)
 0.6m, 14m (sand target)

Attitude : horizontal

G value of 48Y cylinder obtained drop test was

0.6m 12 G
 14m 100 G

, as shown in figure 6.

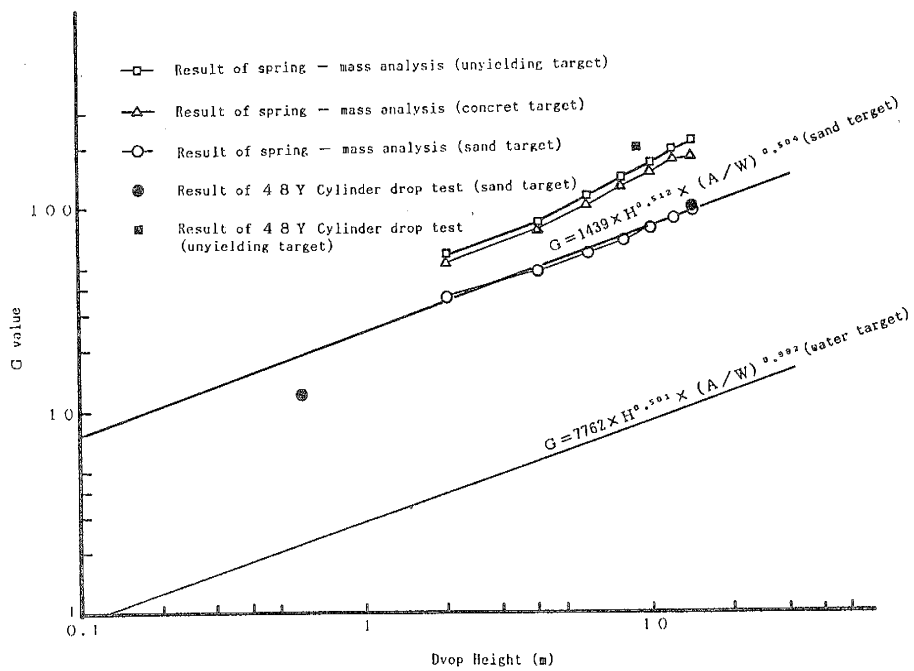

Figure 6 Relation between G value and drop height of 48Y cylinder

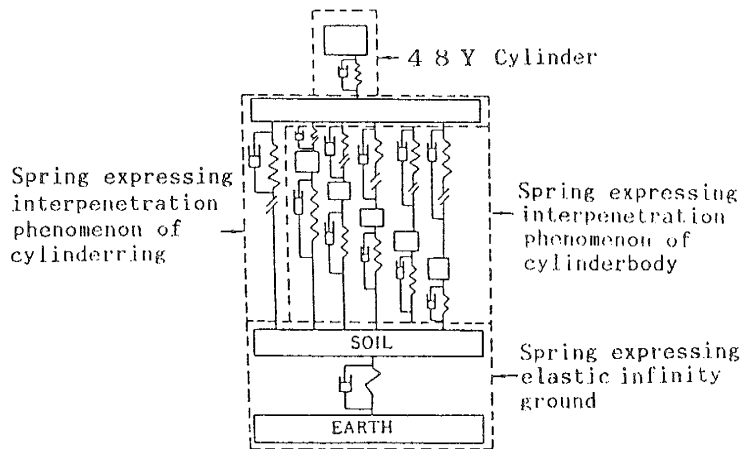

Figure 7 Spring-mass model

5. CONSIDERATION

The following consideration are obtained in account of the relation shown in figure 6.

- ① The regression equation (2) set up from the drop test of steel test samples onto sand target agrees well with the results of 48Y cylinder drop test, it is possible to estimate the G value of 48Y cylinder in case of drop onto sand target by this equation with enough accuracy.
- ② The result of spring-mass model analysis (sand target) agrees well the result of 48Y cylinder drop test. So that the analysis method is appropriate, it is possible to estimate the G value of 48Y cylinder in case of drop onto sand target by this method with enough accuracy.
- ③ According to the appropriateness of analysis method as described in ② and the result of the 48Y cylinder drop test onto sand target, it is useful to apply the spring-mass model analysis to unyielding target and concrete target, G value could be presume by this analysis.
- ④ The regression equation (3) set up from the drop test of steel test samples onto water target is useful to presume G value of 48Y cylinder drop onto water target.

6. CONCLUSION

In this study, the regression equation which estimate the G value is obtained from the drop test of steel test samples. And appropriateness of regression equation is explained by the result of 48Y drop test which performed in the study of Japanese utility "Study on safety during the transport of natural uranium-hexafluoride".

It is shown that spring-mass analysis is useful to presume G value of 48Y cylinder drop. These result is useful to estimate the safety evaluation of package during the transport, and it is necessary for improvement of accuracy to study the application range of regression equation, properties of target, etc.

7. REFERENCE

- 1) IAEA Safety Standard, Safety Series No.6, IAEA, 1985