

Improvement of Local Resistance of Safety-Related Structures and Reduction of Dynamic Response to Missile Impact Loading

Krutzik, N.J., Fila, A.

Siemens Nuclear Power GmbH (FRAMATOME ANP), Offenbach, Germany

Kostov, M.

Bulgarian Academy of Sciences, Sofia, Bulgaria

Katona, T.

PAKS Nuclear Power Plant LTD, Paks, Hungary

ABSTRACT

Evaluation of the load-bearing and shielding capacity of safety-related structures not designed for missile impact loading (e.g. from aircraft crash) led to problem-specific investigations, conducted with the aim of establishing effective shielding, reinforcing and energy dissipation concepts.

To ensure protection of structures against missile impact, emphasis was placed in this study not only on upgrading the penetration resistance of the structures in the impacted area, but also in particular on reducing the dynamic response induced by impact loads. Although a number of shielding concepts exist which are useful in a theoretical sense, only a few of these are of any practical significance due to the rather small region affected by impact loading and the rather high magnitude of the loads.

Any shielding concept suitable for protecting a building against the impact of a missile (e.g. aircraft) over its entire outer surface must provide the target with homogeneous protection in the form of a jacket of high strength and high energy dissipation capacity.

Of the various concepts investigated, the most promising seems to be that providing protection by means of hollow-wall designs or special shielding elements, both made of energy-absorbing high-quality steel-fiber-reinforced concrete [1].

This paper covers studies of different local design concepts for the targeted regions and material parameters which have a strong influence on the penetration resistance as well as energy dissipation capabilities of the impacted building. Possibilities for reinforcing the outer shells of typical buildings not originally designed to withstand missile impact are also presented.

INTRODUCTION

In recent years, discussions have arisen concerning the necessity for upgrading the protection of buildings and structures containing safety-related equipment located in specific regions to ensure adequate shielding against missile impact loads (such as those of missiles or from military aircraft). These discussions were centered on plants designed at different points in time; i.e. based on differing requirements as regards missile or aircraft impact loading conditions.

Contrary to seismic loading conditions, for which plant operators have been able to comply with all of the increasingly stringent requirements stipulated in the course of the past decades, a similar compliance in the case of missile (or aircraft crash impact) is impossible without large-scale structural modifications. This situation is due to the fact that in the event of, for example, an aircraft crash, not only the global but also the local structural load-carrying capabilities are of importance. The problem is made even more complicated by the fact that upgrading not only entails improvement of penetration protection at the point of impact, but also involves the functionality of the systems and components inside the buildings when subjected to induced vibration.

Therefore, not only the necessity for improving penetration protection but also the need to reduce the expected dynamic response to a level which can be accommodated by the equipment in question is of primary importance [2]. Basic feasibility in this regard has been verified by means of case studies and analyses performed for wall thicknesses of representative regions of safety-related buildings.

Of course, the upgrading of existing buildings requires the clarification of numerous other questions as well. Foremost in this regard is a sufficient load-carrying capacity on the part of the structure as well as the whole building to withstand the loads resulting from the impact. This question is investigated below using two typical building design concepts as examples. First, however, analyses of steel-fiber-reinforced concrete plates and impact shielding elements, required for verification of the impact protection design concepts, are briefly described. The section after that addresses the possibilities for reducing the applied loads using hollow-wall designs and baffle-type shielding elements as well as for limiting the dynamic response of the impacted structure.

PRELIMINARY INVESTIGATIONS

Within the framework of impact protection studies, preliminary investigations were conducted of the nonlinear behavior and the dimensions of selected flat and curved reinforced-concrete plates as well as of building areas provided with hollow-wall designs (floor joints and edges) [3]. These studies represented an initial step in determining the element design parameters for further shielding concepts. Although the primary goal of shielding such structures is to increase penetration resistance, it is the anticipated dynamic response to missile impact which represents the most important design parameter as far as the equipment housed inside the structure is concerned. In this connection, particular importance was placed on reducing the shear forces expected to occur at the load transmission locations for various selections of parameters. Analyses revealed that thin plates and shells, loaded to their respective limit loads, display considerable capacity for plastic deformation as well as considerable energy dissipation capabilities, thus leading to the conclusion that an outer shell concept based on a hollow-wall design and with specially designed shielding elements (baffles) made from steel-fiber-reinforced concrete would allow the desired objectives to be achieved.

Targets Made of Normal and Steel-Fiber-Reinforced Concrete

First, analyses were conducted to determine the load-carrying behavior of thin plates of various spans and wall thicknesses made from normal as well as steel-fiber-reinforced concrete (Figure 1).

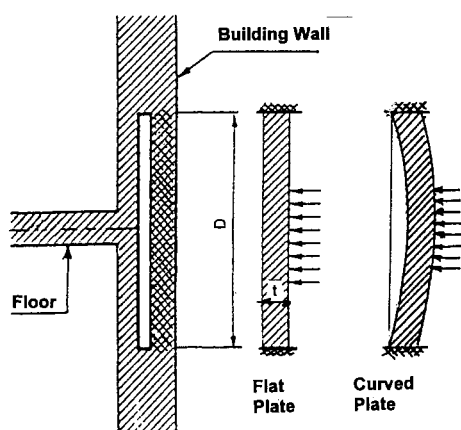

Fig. 1: Evaluation of Limit Capacity of Steel Fiber and Normal Concrete Plates

The first nonlinear limit load analyses were performed based on selected plates having a span of 10 m, comparatively strong shear reinforcement and the maximum allowable concrete parameters. The results of the analyses, particularly the maximum displacements, showed that the minimum wall thickness for such plates when made of normal concrete (NC) B35 would have to be approximately 1.1 m, and about 0.9 m for plates made of steel-fiber-reinforced concrete (FC).

When analyzing concrete plates reinforced with steel fibers, modified material laws were applied which took the particular properties of steel-fiber-reinforced concrete with regard to impact loading into account.

A series of analyses was conducted for reinforced-concrete plates having spans of 5 m, 7.5 m and 10 m, different shear reinforcements and different wall thicknesses. The desired permanent deformations incurred and the allowable high

exploitation of load-carrying capacities, the wall thickness required for plates with a span of 10 m made of normal concrete would be about 1.1 m while for a steel-fiber-reinforced concrete plate with a span of 5 m the wall thickness could be reduced to 0.6 m (Table 1).

Table 1: Parameters and Results for Investigated Flat Plates

Plate No.	t [m]	Diameter [m]	Concrete Type	Reinforcement		Max. Displ. [cm]	Strain [%]		
				Bending cm^2/m	Shear cm^2/m^2		ϵ_s	ϵ_B	ϵ_{Bu}
1	1.1	10	NC	52	100	14.2	2.6	-4.5	3.9
2	0.9	10	NC	75	145	18.5	2.8	-7.2	1.7
3	0.9	10	FC	70	135	21.4	2.3	-7.1	4.9
4	0.8	7.5	FC	65	150	26.3	4.9	-12.1	3.6
5	0.8	5.0	FC	55	155	12.5	3.0	-7.1	3.5
6	0.6	4.8	FC	60	180	38.8	8.2	-26.6	7.0

In order to fully exploit the load-carrying capacities and achieve a high energy dissipation capability, loading of the outer shell must exceed the limit load and full use must be made of the (sufficiently wide) cavity such that only a small remaining impact load is transmitted to the inner shell (Figures 1, 3 and 4). Deflection could be further reduced by giving the plates a slight curvature [4]. The reduced displacement of 30 cm represents a structurally acceptable magnitude for a cavity which can be feasibly incorporated into the structural design.

A comparison of the shear force amplification curves derived for plates made from normal concrete with those determined for plates made from steel-fiber-reinforced concrete reveals that steel-fiber-reinforced plates of the same spans and wall thicknesses as normal concrete plates permit a greater reduction of the loads 30% and 50%.

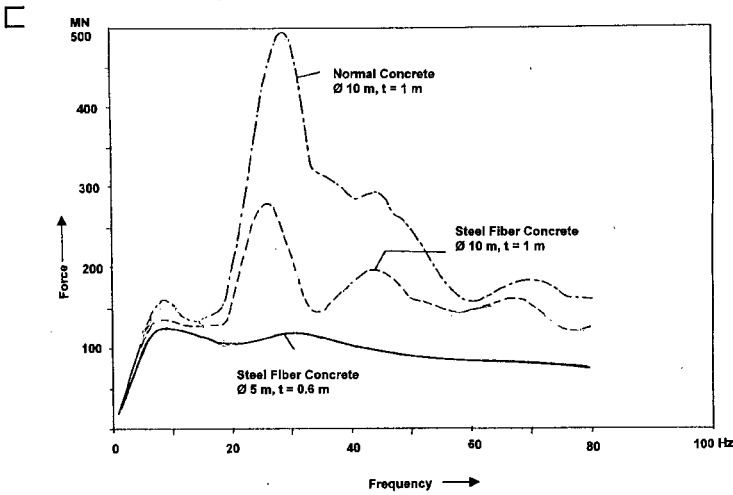

Fig. 2: Frequency Dependency of Shear Forces Transferred by Different Plates due to Impact (RLF) Loading

Subsequent to the aforementioned preliminary investigations related to practical design solutions for flat targets and considering the reference loading function (RLF) corresponding to an aircraft crash [6] analyses were conducted of the plastic behavior of hollow-wall outer shells at floor-to-wall joints as well as edges of real structures with full penetration protection. These analyses were performed using 3D mathematical models as well as modified material data for steel-fiber-reinforced concrete ([7].

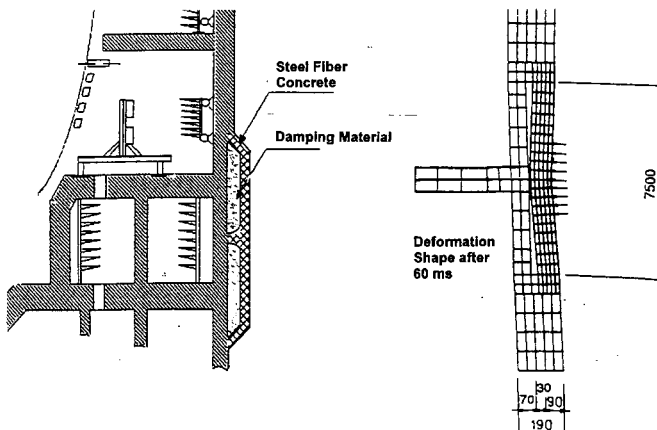

Fig. 3: Double Shell Design for Floor Regions to Wall Point

The basic feasibility of the proposed impact-mitigating design options (Figures 3 and 4) was verified in advance by the considerable deformations calculated for the outer shells in question. Cavities with dimensions of approximately 30 cm and 40 cm corresponding to the maximum deformations for steel-fiber-reinforced concrete are feasible for the wall thicknesses of structures with full penetration protection (between 1.80 and 2.00 m). Cavities of this size easily can be accommodated within the regular or slightly enlarged wall thickness (Figures 3 and 4). Since the transmission of minor impact loads to the inner shell (i.e. to the floor) is allowable, this parameter does not seem to be of decisive importance.

The required reinforcement can be accommodated without any problem.

A comparison of the displacement time histories obtained for the target shell center, the reaction forces and, in particular, the modified loading functions (Figure 5) resulting therefrom reveals that the hollow-wall design considerably reduces the transmitted forces and the dynamic response at floor joints. The corresponding design parameters and calculation scheme for impact in the region of edges are shown in Figure 6.

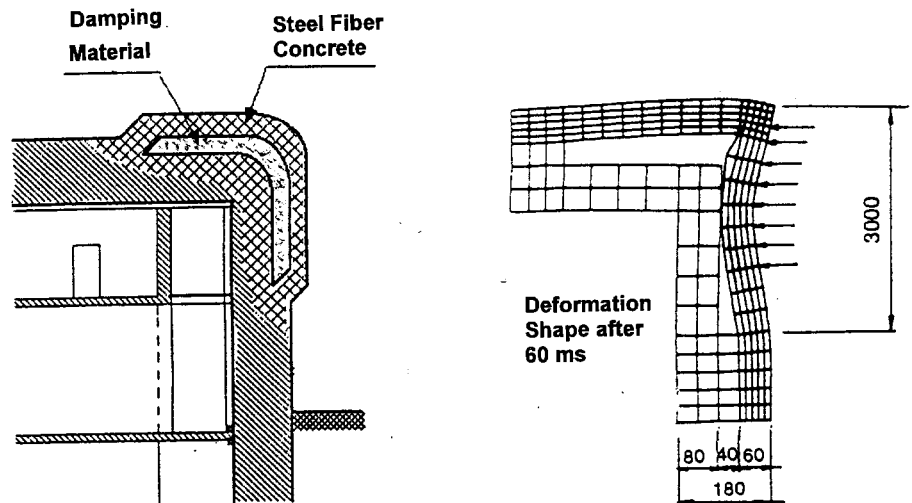

Fig. 4: Double Shell Design for Edges Regions

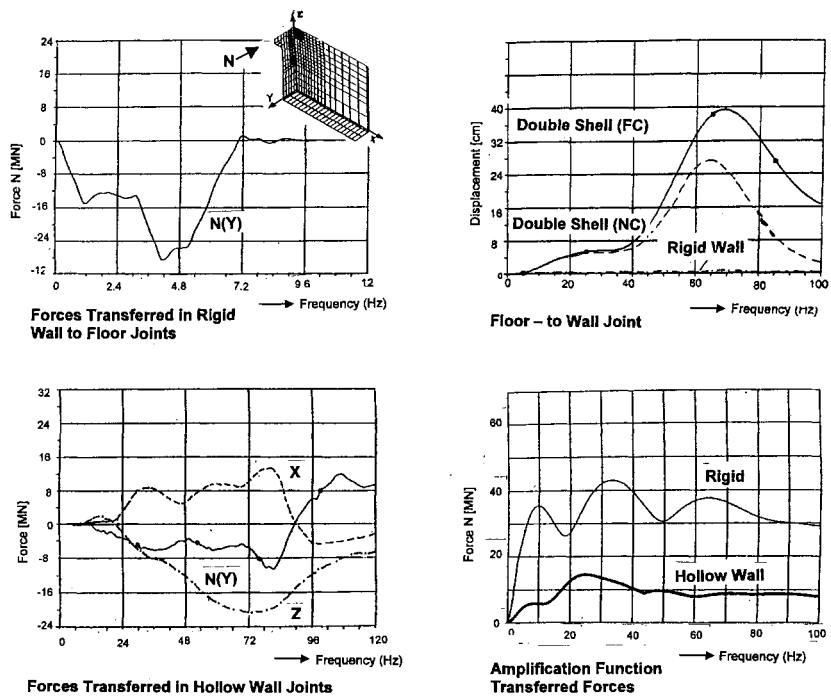

Fig. 5: Reduction of Load Transferred in Wall to Floor Joint Regions for Normal (NC) and Steel Fiber (FC) Concrete

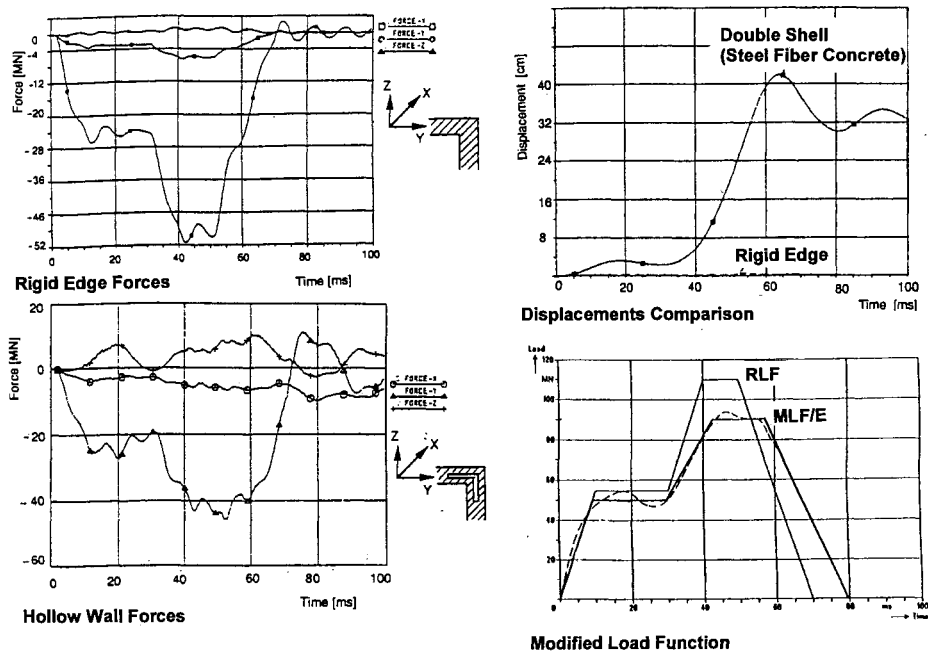

Fig. 6: Reduction of Transferred Load on Edge Regions

Prefabricated Shielding Elements (Baffles)

The results of previous investigations served as a basis for elaborating a conceptual design for special baffle-type shielding elements for the protection of existing safety-related structures.

The "baffle element design concept" which served as the starting point for subsequent detailed analyses is shown in Figure 7. The outside dimensions (width and height) of the plate can be adapted as required, depending on the given dimensions of the building to be protected as well as any manufacturing-related problems.

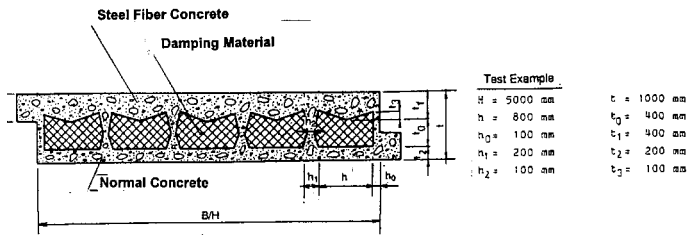

Fig. 7: Shielding Element ("Baffle"), Constructional Parameters

The analyses conducted up to this point for such shielding elements led to the conclusion that a thickness of approximately 0.4 m for the outer plate of the baffle element can be considered to be adequate. The required cavity size was specified, based on knowledge gained from previous studies, as between 30 and 40 cm.

Analysis of several optimization measures involving variations of the design parameters enabled dimensions to be determined such that baffle bar failure (due to compression) and baffle outer plate segment failure (from bending) occur roughly at the same time.

Figure 8 shows the deformation condition when load is applied at the center of the baffle element (over an area of 7 m²). The change in RLF (reference loading function) expected due to nonlinear effects is shown in Figure 9.

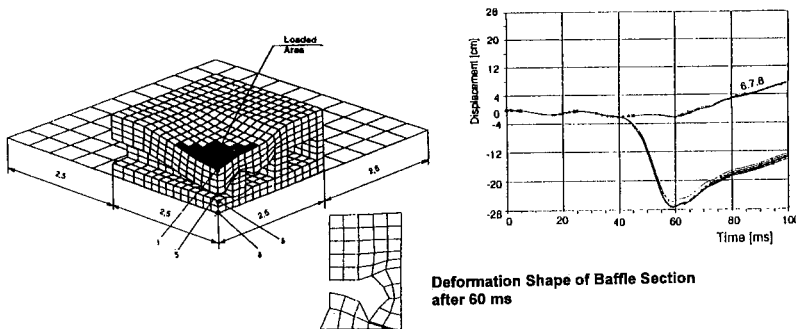

Fig. 8 Mathematical Model and Deformation Shape of the Baffle Element

remained unclarified. However, these questions could not be resolved by means of parametric studies but rather through experimental testing conducted on plates manufactured from steel-fiber-reinforced, normal and

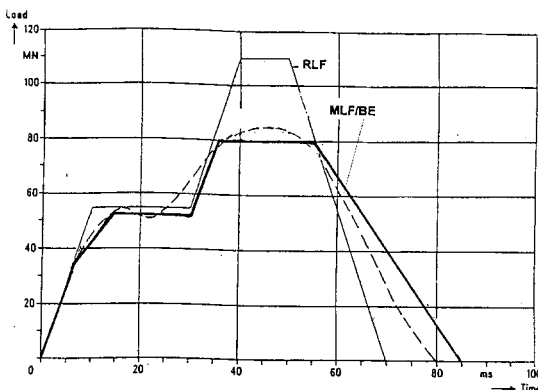

Fig 9 Modified Load Function for the Baffle Element (MLF/BE) Placed on Rigid Wall

From the point of view of improving baffle element performance characteristics as well as with regard to manufacturing cost it was the insufficiently clarified questions regarding fill material which appeared to be of greater importance. The supporting effect provided by cavity damping material and its influence on baffle element energy dissipation likewise

The deadweight of the baffle elements together with their structural design and the selection of materials is also significant. The possibility for improving building penetration protection is also affected by the capability of vertical walls and the building foundation to accommodate additional dead loads.

Parametric studies and tests of baffle element plates made from a combination of steel-fiber-reinforced and lightweight concrete for purposes of weight reduction would therefore be of primary importance.

IMPROVEMENT OF IMPACT RESISTANCE OF BUILDINGS BY REDUCTION OF INDUCED LOADS AND DYNAMIC RESPONSE RESULTS

Of course, the upgrading of existing safety-related facilities and plants requires the clarification of numerous other questions as well. Foremost in this regard is a sufficient load-carrying capacity of the global structure to absorb the loads resulting from the impact of a missile (or postulated aircraft). This question is investigated below using two typical structures as examples and taking into consideration the strengthening effect provided by installed shielding elements of the type mentioned above in order to determine maximum local deformation and exploitation of load-carrying capability.

The investigations were conducted for representative areas (walls) of a typical axisymmetrical building and a typical rectangular building (Figure 10), taking into account local and global loading of the impacted regions of the outer walls resulting during loading to their limit load (or even overloading). Shielding elements (as shown in Figure 7) having outside dimensions of approximately 5 x 5 m and 6 x 6 m installed in characteristic areas of the building structure served as the point of departure for these analyses.

In these investigations the effects of adjacent baffle elements were neglected. For each analysis the load was applied at the center of the baffle element (distributed over an area of 7 m²).

The maximum deformation as well as the resulting local usage factor of the load-bearing capacity of the outer walls (expressed as a percentage) are compiled in Table 2.

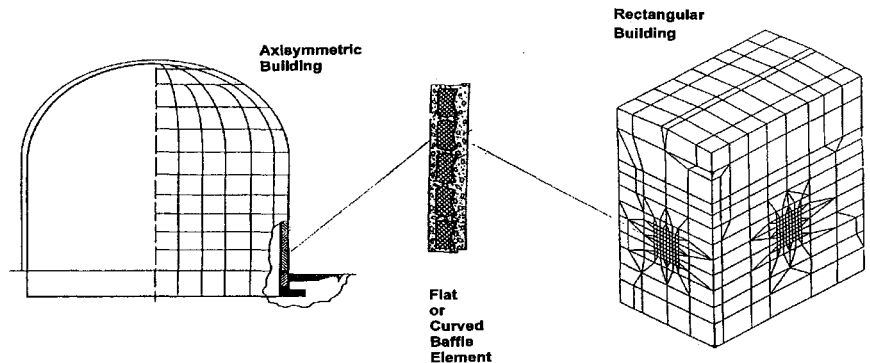

Fig.10: Protection of Typical Using Shielding („Baffle Elements“)

On the basis of these results the following was determined and evaluated:

- The overall structural stability of the building and its local load-bearing capacity during impact (RLF) loading. In case of the investigated buildings the load bearing capacity has been found sufficient.
- Displacement of the building walls due to local loads expected to occur for existing outer shell and wall thicknesses (between 0.8 and 1.0 m) under consideration of 5 x 5 m baffle elements (see Table 2).
- The usage factors of the vertical load-bearing walls above the foundation plate (required wall thicknesses)

Subsequent to the aforementioned investigations, the dynamic responses expected to occur in the representative buildings described above were determined. These analyses were performed using an axisymmetrical shell model for the first building and a 3D plate element model (Figure 10) for the second. In order to consider soil-structure effects, medium-type soil properties were assumed.

Table 2: Displacements and Usage Factors of Outer Shell/Wall in Characteristic Impact Regions of the Buildings for Different Types of Load Application (Directly on Shell and on Baffle Element "BE")

Structure	Diameter [m] W / H [m]	Wall Thickness [m]	Load Application	Wall Dis- placement [cm]	Usage Factor (%)			
					Forces		Moments	
					Meridional	Tangential	Meridional	Tangential
Axisymmet.. Building								
1	Ø 60	0.60	on shell	4.7	216	451	376	51
2	Ø 60	0.80	on shell	3.4	149	302	245	49
3	Ø 60	1.00	on shell	2.7	116	224	176	50
4	Ø 60	0.60	on BE	2.1	151	334	682	159
5	Ø 60	0.80	on BE	1.8	116	238	411	136
6	Ø 60	1.00	on BE	1.6	93	182	284	122
7	Ø 66	1.60	on shell	2.9	<100	<100	±100	<100
Rectangular Building								
1	57/31	0.60	on wall	40.0	483	415	80	912
2	57/31	1.20	on wall	8.5	358	255	227	151
3	57/31	0.60	on BE	27.7	375	351	411	585
4	57/31	1.20	on BE	6.9	154	217	180	164
5	57/31	1.80	on wall	3.7	<100	<100	±100	100

As the baffle elements can only make an insignificant contribution towards modifying the load distribution of the outer walls, they were modeled using shell and plate elements of equivalent wall thickness. However, the masses of the shielding elements were added to the outer shell as lumped mass.

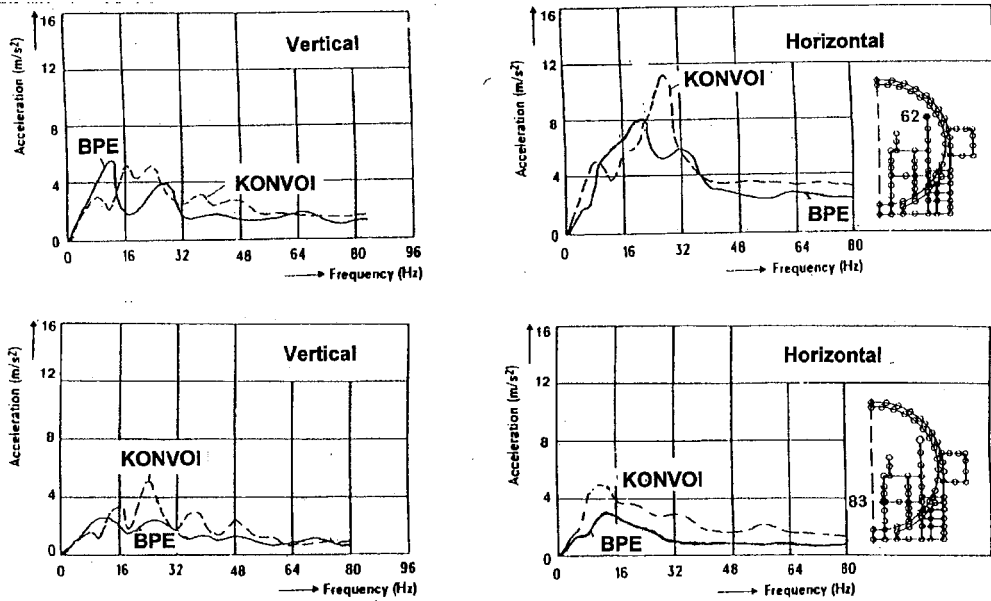

Fig. 11: Dynamic Response of a Typical Axisymmetric Reactor Building Protected Using Baffle Plate Elements (BPE), Comparison to KONVOI (MLF) Spectra

Due to the plastic deformations expected to occur upon impact in the area of the loaded baffle element as well as the related dissipation of energy, a correspondingly modified loading function (Figure 9) was applied at the impact location.

The response spectra calculated for characteristic areas of the building interior are shown in Figure 11. The data demonstrate that these spectra are basically comparable to those for buildings designed using the modified [5] aircraft crash loading function (MLF) of the German KONVOI-series plants.

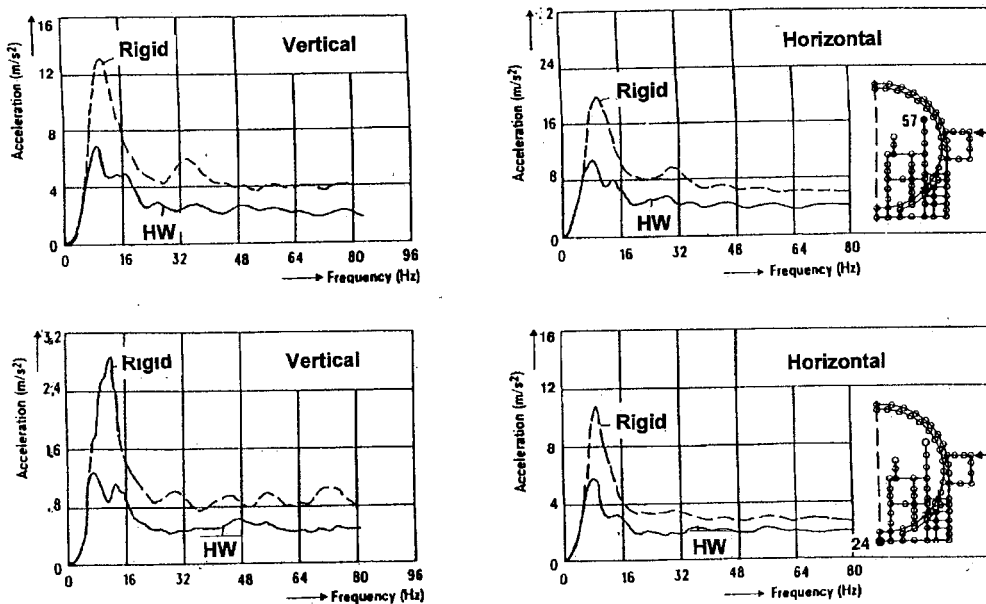

Fig. 12: Dynamic Response Obtained for Impact in Edge Region Designed as Rigid and Hollow-Wall Performed in Steel Fiber Concrete

For a postulated implementation of hollow-wall design solutions in this area, as shown in Figure 4, a comparative study of the dynamic responses is presented as well.

The impact-reducing properties of hollow-wall designs were demonstrated on the basis of analyses conducted assuming full rigidity in the zone of impact on a typical reactor building (main steam and feedwater valve compartment) and by applying a modified hollow-wall loading function (Figure 6). Acceleration response spectra from representative locations in the building interior derived from these two analyses were plotted together with the spectra obtained for rigid conditions.

A comparison of these spectra (Figure 12) reveals that spectral accelerations (particularly those in the significant frequency range) can be reduced considerably through the implementation of a hollow-wall design at the valve compartment corners.

CONCLUSION

The investigations conducted to date of appropriately designed shielding elements have, in particular, revealed the feasibility and qualification of the designed protection concepts for reducing missile and aircraft impact loads as well as the dynamic responses induced inside the impacted buildings.

A considerable reduction in dynamic response can be achieved through the implementation of hollow-wall outer shell designs at edges and floor joints (in new buildings) as well as by backfitting existing buildings with baffle elements.

Based on the nonlinear analyses which have been performed and the current requirements regarding impact protection, the total wall thickness required for flat or curved shielding (baffle) elements is around 1 m. This design thickness includes a cavity having a diameter of approximately 40 cm. The overall dimensions of the baffle elements can be adapted to plant-specific design concepts and requirements.

Due to the high plastic deformation capability of steel-fiber-reinforced concrete, plates and shells made of this material allow an even greater reduction in loads and dynamic response.

However, prior to making a decision as regards the use of shielding elements, it is first necessary to investigate the load-carrying behavior and local-carrying capacities of the building region in question (including the effect provided by installed baffle elements), based on the specific conditions of the existing buildings.

These analyses should be conducted for representative building areas (walls) taking the local and global dimensions of the wall sections in question as well as exploitation of the load-carrying capacity up to the limit load (or even local overloading) into consideration. Variation of the external dimensions of the shielding (baffle) elements allows the loads to be distributed over a correspondingly large area of the outer wall, which is generally thinner in the case of early-generation plants, thereby increasing the load-carrying capability of the outer wall.

In any case, the knowledge gained with respect to safety-related buildings of early-generation plants and facilities shows that missile or aircraft impact loads can be accommodated by a conventionally well-designed building if the outer walls are reinforced with suitable shielding elements connected in an appropriate manner to the load-bearing walls.

However, for new-generation safety-related buildings, a design concept should be selected and implemented (double shell or hollow-wall) which, while providing penetration protection and reducing dynamic response, will not noticeably increase effort and expenditure.

REFERENCES

- [1] Stangenberg, F., Buttman, P., Impact testing of steel fibre reinforced concrete slabs with liners, 5th SMiRT Conference, Berlin, August 1979, (J7/15)
- [2] Krutzik N.J., Reduction of the Dynamic Response by Aircraft Crash on Building Structures, Nuclear Engineering and Design (110), 1988
- [3] Stangenberg, F., Krutzik, N., Vorausberechnungen zur stoßmindernden Auslegung starrer äußerer Gebäudebereiche von Bauwerken beim Lastfall Flugzeugabsturz für ebene Platten Technischer Bericht KWU ZOD72/87/0043
- [4] Fila, A., Krutzik, N.J., Vorausberechnungen zur stoßmindernden Auslegung starrer äußerer Gebäudebereiche von Bauwerken beim Lastfall Flugzeugabsturz für gekrümmte Platten, Technischer Bericht KWU ZOD72/87/0053
- [5] Chedmail, J., Krutzik, N.J., Equivalent loading due to airplane crash taking into account the nonlinearities of impact reinforced concrete buildings, Nuclear Engineering and Design (85) 1985
- [6] RSK Guidelines for Pressurized Water Reactors, 3rd Edition, October 1981
- [7] Tropp, R. NONDYN, Rechenprogramm zur nichtlinearen Berechnung von Stahlbeton und elastoplastischen Werkstoffen, Arbeitsbericht KWU R621/84/0039