

ABSTRACT

DUNCAN, ASHLEE WALKER. Comparative Epidemiology of *Bartonella* Infection in Dogs and Humans. (Under the direction of Edward B. Breitschwerdt and Maria T. Correa).

The genus *Bartonella* is composed 20 species or subspecies of vector-transmitted, fastidious, gram-negative bacteria, which are classified as emerging pathogens in human and veterinary medicine. Due to their intracellular localization, successful microbiological isolation of *Bartonella* species is difficult to achieve and hinders the attribution of disease causation to *Bartonella* infection. Research was initiated to develop a pre-enrichment medium that would support the isolation of *Bartonella* species. The use of this novel medium, *Bartonella*/alpha-*Proteobacteria* Growth Medium (BAPGM), facilitated successful isolation of both single and co-cultures of multiple *Bartonella* species. Subsequently, a prospective study was designed to test the hypothesis that the detection and isolation of *Bartonella* in clinical samples, collected from dogs, are enhanced by pre-enrichment in liquid BAPGM prior to blood agar plating when compared to traditional diagnostic methods. No isolates were obtained when samples were cultured on a blood agar plate; however, refinements to the BAPGM method resulted in the successful isolation of single and co-infections with *Bartonella* species in clinical samples collected from sick dogs. This study resulted in the preliminary validation of a multi-faceted approach combining pre-enrichment culture with PCR amplification to identify and isolate *Bartonella* species from the blood of sick dogs.

Next, a study was conducted to assess the utility of the BAPGM-PCR combinational approach using blood samples collected from immunocompetent human patients with arthropod and occupational animal contact. Similar to results obtained in

dogs, this multi-faceted method facilitated the detection and subsequent isolation of single and co-infections with multiple *Bartonella* species in the blood of human participants. To our knowledge, this study was the first to demonstrate concurrent infection with two *Bartonella* species or strains in the same individual.

In the final segment of the research presented, it was hypothesized that the development of lymphoma in Golden Retrievers may be associated with chronic infection with vector-borne pathogens. Using a matched, case-control study design and PCR analyses and DNA sequencing, single and co-infections with multiple *Bartonella* species were detected in the blood and lymph nodes of Golden Retrievers with lymphoma and in healthy Golden Retrievers; no *Anaplasma* or *Ehrlichia* DNA was detected in samples from any dog. There were no differences in the molecular prevalence of *Bartonella* infections or in the specific *Bartonella* species detected in the blood or lymph nodes of dogs with lymphoma (5/28 dogs, 17.9%) when compared to the clinically healthy controls (10/56 dogs, 17.9%). To our knowledge, this is the first report in which *Bartonella* DNA was detected in the lymph nodes of clinically healthy dogs or in dogs with lymphoma. Consistent with earlier reports, a significantly higher proportion of healthy Golden Retrievers were receiving monthly acaricide treatments (2.6 times higher), when compared to dogs with lymphoma. In addition, Golden Retrievers that were PCR positive for *Bartonella* species had prior tick exposure (odds ratio = 3.4) and were classified by their owners as indoor/outdoor dogs (odds ratio = 3.1), when compared to dogs that were PCR negative for *Bartonella* species. Based on these data, longitudinal studies should be conducted to determine whether *Bartonella* species can be transmitted by ticks, whether

lymphatic infection is persistent, or whether these bacteria may contribute to the development of lymphoma.

The utilization of BAPGM for the isolation of *Bartonella* species from naturally infected patients represents an important contribution to worldwide research efforts to enhance the isolation and facilitate the microbiological study of these fastidious bacteria. Further, it appears that similar *Bartonella* species induce persistent blood-borne infections in humans and dogs. The current findings highlight the zoonotic potential of this genus and further validate *Bartonella* species as important, emerging pathogens in human and veterinary medicine.

Comparative Epidemiology of *Bartonella* Infection in Dogs and Humans

By
ASHLEE WALKER DUNCAN

A dissertation submitted to the Graduate Faculty of
North Carolina State University
in partial fulfillment of the
requirements for the Degree of
Doctor of Philosophy

Comparative Biomedical Sciences

Raleigh, North Carolina
2007

APPROVED BY:

Stephanie K. Kordick

Robert M. Kelly

Maria T. Correa
Co-chair of Advisory Committee

Edward B. Breitschwerdt
Co-chair of Advisory Committee

BIOGRAPHY

Ashlee received her Bachelor of Science from the University of Georgia and her Master of Science from North Carolina State University.

Table of Contents

List of Tables	v
List of Figures	vi
Chapter 1. <i>Bartonella</i> species in dogs and humans: comparative epidemiologic features, methods of detection, and as potential co-factors in oncogenesis	1
Introduction.....	2
<i>Bartonella</i> species.....	7
<i>Bartonella bacilliformis</i>	8
<i>Bartonella quintana</i>	11
<i>Bartonella henselae</i>	19
<i>Bartonella elizabethae</i>	32
<i>Bartonella vinsonii</i> subspecies <i>berkhoffii</i>	34
<i>Bartonella bovis</i>	41
Summary	45
Comparative epidemiological considerations: The dog as a model.....	46
Introduction.....	46
Common diseases related to <i>Bartonella</i> infection in dogs and humans	48
Data evaluation and summary.....	56
Detection of <i>Bartonella</i> species in clinical samples	58
Conventional microbiological methods	59
Alternative microbiological methods.....	60
Summary	63
Potential link between chronic bacterial infection and cancer.....	63
Introduction.....	63
Viral agents and oncogenesis.....	64
Bacterial agents and oncogenesis.....	72
<i>Bartonella</i> Type IV secretion systems	81
Antibiotic therapy and the resolution of vasoproliferative or lymphoid tumors in <i>Bartonella</i> -infected individuals	84
Summary	85
References.....	88

Chapter 2. A novel chemically modified liquid medium that will support the growth of seven <i>Bartonella</i> species.....	120
Introduction.....	122
Materials and methods.....	124
Results.....	130
Discussion.....	133
References.....	137
Chapter 3. A combined approach for the enhanced detection and isolation of <i>Bartonella</i> species in dog blood samples: pre-enrichment liquid culture followed by PCR and subculture onto agar plates	148
Summary.....	150
Introduction.....	151
Materials and methods.....	153
Results.....	159
Discussion.....	163
References.....	169
Chapter 4. <i>Bartonella henselae</i> and <i>B. vinsonii</i> subspecies <i>berkhoffii</i> in blood of immunocompetent persons with arthropod and animal contact.....	185
Introduction.....	187
The study.....	187
References.....	192
Chapter 5. <i>Bartonella</i> DNA in the blood and lymph nodes of Golden Retrievers with lymphoma and in healthy controls	204
Abstract.....	205
Introduction.....	207
Materials and methods.....	211
Results.....	219
Discussion.....	222
References.....	226
Chapter 6. Summary and conclusions	237

List of Tables

Chapter 3. A combined approach for the enhanced detection and isolation of *Bartonella* species in dog blood samples: pre-enrichment liquid culture followed by PCR and subculture onto agar plates

Table 1. Results for <i>Bartonella</i> PCR-positive dogs from phase 1	179
Table 2. Results for <i>Bartonella</i> PCR-positive dogs from phase 2	180
Table 3. Results for selected <i>Bartonella</i> seroreactive and PCR-positive dogs from phase 3	182

Chapter 4. Detection of *Bartonella henselae* and *Bartonella vinsonii* subspecies *berkhoffii* in the blood of immunocompetent persons with arthropod and occupational animal contact

Table 1. Selected demographic and epidemiological information and the <i>Bartonella</i> species sequenced from 14 non-immunocompromised individuals with a history of arthropod and animal contact.....	195
Table 2. Symptoms reported by 14 immunocompetent individuals infected with <i>Bartonella henselae</i> or <i>Bartonella vinsonii</i> subsp. <i>berkhoffii</i> using a survey questionnaire.....	197
Table 3. Serological and PCR results from blood collected at multiple time points from 14 individuals with frequent animal and arthropod contact.....	199

Chapter 5. *Bartonella* DNA in the blood and lymph nodes of Golden Retrievers with lymphoma and in healthy controls

Table 1. <i>Bartonella</i> genus- and species-specific sequences for ITS and Pap31 primers	233
Table 2. <i>Anaplasma</i> and <i>Ehrlichia</i> genus- and species-specific sequences for 16S rRNA primers.....	233
Table 3. Data for all PCR-positive Golden Retrievers enrolled in the study.....	234

List of Figures

Chapter 2. A novel chemically modified liquid medium that will support the growth of seven *Bartonella* species

- Figure 1. Growth curve of *B. henselae* in BAPGM..... 145
Figure 2. Growth curve of *B. quintana* in BAPGM..... 146
Figure 3. Two percent agarose gel electrophoresis of an intergenic spacer region PCR amplification of *Bartonella* cultures in BAPGM..... 147

Chapter 3. A combined approach for the enhanced detection and isolation of *Bartonella* species in dog blood samples: pre-enrichment liquid culture followed by PCR and subculture onto agar plates

- Figure 1. Study design schematic indicating the three distinct phases of the current work 178

Chapter 4. Detection of *Bartonella henselae* and *Bartonella vinsonii* subspecies *berkhoffii* in the blood of immunocompetent persons with arthropod and occupational animal contact

- Figure 1. Schematic diagram that depicts sample processing and testing203

**Chapter 1. *Bartonella* species in dogs and humans:
comparative epidemiologic features, methods of detection, and
as potential co-factors in oncogenesis**

Introduction

Within the last decade, the number of species that comprise the family Bartonellaceae, genus *Bartonella* (alpha subdivision of the class *Proteobacteria*) has expanded from two species to more than 20 species or subspecies of vector-transmitted, fastidious, aerobic, intracellular, gram-negative bacteria that are highly adapted to one or more mammalian reservoir hosts (Boulouis et al., 2005; Chomel et al., 2003; Jacomo et al., 2002). *Bartonella* species can be transmitted by an arthropod vector, including biting flies, fleas, lice, sand flies, and potentially ticks, or alternatively by animal scratches or bites (Boulouis et al., 2005; Breitschwerdt et al., 2000; Chang et al., 2001; Chomel et al., 2004; Halos et al., 2004). Among the 11 species and subspecies known or suspected to be pathogenic in humans, eight have been detected in or isolated from pet dogs and/or cats, thereby highlighting the zoonotic potential of these bacteria (Boulouis et al., 2005; Chomel et al., 2006). It is this zoonotic potential, coupled with the many vectors involved in transmission, and the frequent adaptation to a mammalian reservoir host, that classify *Bartonella* species among the newest and most significant emerging pathogens (Anderson et al., 1997; Avidor et al., 2004; Breitschwerdt et al., 2000; Chang et al., 2000; Karem et al., 2000).

In humans, *Bartonella* species are the causative agent of Carrion's disease, Oroya fever, and verruga peruana (*B. bacilliformis*) (Birtles et al., 1999), trench fever (*B. quintana*) (Brouqui et al., 1999; Raoult et al., 1994; Relman 1995), endocarditis (*B. alsatica*, *B. elizabethae*, *B. henselae*, *B. koehlerae*, *B. quintana*, *B. vinsonii* subspecies

arupensis, *B. vinsonii* subspecies *berkhoffii*) (Avidor et al., 2004; Daly et al., 1993; Fenollar et al., 2005; Hadfield et al., 1993; Raoult et al., 2006; Roux et al., 2000; Spach et al., 1993; Welch et al., 1999), bacillary angiomatosis (*B. henselae*, *B. quintana*) (Clarridge et al., 1995; Koehler et al., 1992; Turgut et al., 2004; Welch et al., 1992), neuroretinitis (*B. grahamii*, *B. quintana*) (George et al., 2006; Kerkhoff et al., 1999), and cat scratch disease (*B. clarridgeiae*, *B. henselae*) (Bergmans et al., 1996; Kordick et al., 1997; Regnery et al., 1992a).

Bartonella infection was not known to cause disease in dogs until 1993, when the first case of canine endocarditis was associated with the novel species, *B. vinsonii* subspecies *berkhoffii* (Breitschwerdt et al., 1995). Since then, *Bartonella* species have been implicated in several disease processes in dogs including: *B. clarridgeiae* and *B. washoensis* in endocarditis (Chomel et al., 2001; Chomel et al., 2003), *B. vinsonii* (*berkhoffii*) in granulomatous lymphadenitis and rhinitis (Pappalardo et al., 2000b), *B. henselae* and *B. clarridgeiae* in granulomatous hepatitis and lymphocytic hepatitis (Gillespie et al., 2003), *B. henselae* in peliosis hepatis (Kitchell et al., 2000), and *B. henselae* and *B. elizabethae* in other various systemic illnesses (Mexas et al., 2002).

As a cause of disease in human and veterinary medicine, *Bartonella* are highly adapted to their mammalian reservoir hosts. *Bartonella* species are the only bacterial pathogens known to infect the human red blood cell (Dooley 1980; Seubert et al., 2002). In addition, *Bartonella* are able to invade endothelial cells, triggering proliferation and migration of these cells, and resulting in the vasoproliferative lesions of bacillary angiomatosis and peliosis hepatis (Dehio 2004). Further, recent reports have shown that

Bartonella may invade erythroblasts, a nucleated cell in the bone marrow from which red blood cells develop (Rolain et al., 2003), CD34+ progenitor cells (Mandle et al., 2005), and dendritic cells (Vermi et al., 2006) of their hosts, thereby providing a unique strategy for bacterial persistence. This intra-erythrocytic and endothelial localization leads to persistent blood-borne infections; further, the infection of progenitor cells, followed by non-hemolytic intracellular colonization of erythrocytes, would preserve the organisms for efficient vector transmission, protect *Bartonella* from the host immune response, facilitate widespread vascular dispersion, and potentially contribute to reduced antimicrobial efficiency (Jacomo et al., 2002; Rolain et al., 2002).

Until the early 1990s, bartonellosis was a disease confined to certain regions of the Andes Mountains in Peru (*B. bacilliformis* in Carrion's disease, Oroya fever, verruga peruana) or acquired in trench warfare during World Wars I and II (*B. quintana* in trench fever). The role of *Bartonella* species as modern-day pathogens was first recognized with the onset of the human immunodeficiency virus/acquired immunodeficiency syndrome (HIV/AIDS) epidemic. Initially, 16S rRNA PCR was used to amplify bacterial DNA from skin lesions of AIDS patients with bacillary angiomatosis, a syndrome characterized by vasoproliferative skin lesions (Relman et al., 1990). It was concurrently reported that "unculturable" Warthin-Starry silver staining bacilli could be detected in patients with peliosis hepatis, a rare hepatic lesion found in people with chronic wasting diseases such as pulmonary tuberculosis, advanced cancer, or HIV infection (Perkocha et al., 1990). Simultaneously, the isolation of a novel, fastidious, gram-negative organism in blood cultures from both immunocompetent and immunocompromised patients with fever and

bacteremia was reported (Slater et al., 1990). The organisms described in these three manuscripts were all subsequently characterized as *Bartonella (Rochalimaea) quintana* or *Bartonella (Rochalimaea) henselae*, the latter of which was defined as a new species in 1992 (Regnery et al., 1992a; Welch et al., 1992). Since this initial association of *Bartonella* species with diseases in immunocompromised patients, research efforts have further elucidated the importance of this genus as highly adapted bacteria and as stealth human and veterinary pathogens (Merrell et al., 2004).

Prior to 1993, *Bartonella bacilliformis* was the only member of the genus *Bartonella*, classified into the order *Rickettsiales* in the family Bartonellaceae, which also included the genus *Grahamella*, a group of pathogens that infect small mammals, primarily rodents (O'Connor et al., 1991). Due to their ability to grow on axenic media, *Bartonella* and *Grahamella* and a third rickettsial species, *Rochalimaea quintana*, the agent of trench fever, were fundamentally different from other rickettsiae. After review of the 16S rRNA sequence data for *B. bacilliformis* published in 1991, it was determined that *B. bacilliformis* was most closely related to *R. quintana* with 91.7% homology (O'Connor et al., 1991). When other phylogenetic and microbiological characteristics were reviewed, *R. quintana* was transferred out of the family Rickettsiaceae and into the family Bartonellaceae within the order *Rickettsiales*. Shortly following the identification and characterization of *B. henselae* in 1992, molecular techniques, such as whole-genome DNA-DNA hybridization, 16S rRNA gene sequence comparisons, and G + C content analysis, provided researchers the opportunity to determine the genetic relationship between *Rochalimaea* and *Bartonella* species. Information acquired from these types of

studies prompted Brenner et al. (1993) to propose that the previously designated *Rochalimaea* species be united with the genus *Bartonella*. This reclassification also resulted in the transfer of these organisms from the family Rickettsiaceae to the family Bartonellaceae, which previously included only *B. bacilliformis*, and removed the family Bartonellaceae from the order Rickettsiales. The unified genus *Bartonella* included *B. bacilliformis*, *B. quintana*, *B. vinsonii*, *B. henselae*, and *B. elizabethae*.

In 1995, Birtles et al. (1995) proposed the unification of the genus *Grahamella* with the genus *Bartonella*, resulting in five additional *Bartonella* species: *B. talpae*, *B. peromysci*, *B. grahamii*, *B. taylorii*, and *B. doshiae*. Shortly thereafter, *B. vinsonii* subspecies *berkhoffii* was isolated from dogs and designated as a new subspecies (Kordick et al., 1996), and *B. clarridgeiae*, isolated from a cat, was characterized as a new species (Lawson et al., 1996). More recently, several new *Bartonella* species have been isolated and characterized: *B. tribocorum* and *B. birtlesii* in rodents (Bermond et al., 2000; Heller et al., 1998), *B. alsatica* in wild rabbits (Heller et al., 1999), and *B. koehlerae* and *B. weissii* in domestic cats (Droz et al., 1999; Regnery et al., 2000). Further, *B. washoensis* was isolated from a human patient with cardiac disease (GenBank Accession No. AF070463 at <http://www.ncbi.nlm.nih.gov>), and *B. vinsonii* subspecies *arupensis* was isolated from the blood of a cattle rancher; in both cases, a rodent reservoir has been proposed (Kosoy et al., 2003; Welch et al., 1999). Originally isolated from cats and named *B. weissii*, *B. bovis* has been recently reported in beef and dairy cattle in the United States (Breitschwerdt et al., 2001; Chang et al., 2000), dairy cattle from France (Bermond et al., 2002; Maillard et al., 2004; Maillard et al., 2006), and isolated from beef cattle in Africa (Raoult et al., 2005).

Taken together, these data indicate that many animals including bovine, canine, feline, human, and rodent species, may serve as chronically infected reservoir hosts for various *Bartonella* species (Boulouis et al., 2005; Chomel et al., 2003).

When comparing *Bartonella* infections in dogs and humans, several parallels in clinical manifestations are observed. *Bartonella* species can be detected in both dogs and humans with lymphadenitis, endocarditis, granulomatous hepatitis, and peliosis hepatis (Bass et al., 1997a; Bass et al., 1997b; Chomel et al., 2004; Gillespie et al., 2003; Kitchell et al., 2000; MacDonald et al., 2004; Raoult et al., 1996). Due to the profound similarities in pathological lesions associated with infection, it has been suggested that the dog may serve as a good natural model for human *Bartonella* infection. Considering the growing list of *Bartonella* species that have been isolated and characterized within the last 15 years, the wide range of reservoir hosts, the diverse list of clinical manifestations of infection, and the striking disease similarities in dogs and humans, *Bartonella* bacteria have proven to be of comparative medical importance.

***Bartonella* species**

This literature review, encompassing both dogs and humans, will focus primarily on the *Bartonella* species detected while conducting my research: *B. bovis*, *B. elizabethae*, *B. henselae*, *B. quintana*, and *B. vinsonii (berkhoffii)*. For historical perspective, a brief review of *B. bacilliformis* will be provided. A summarization of the techniques utilized in

the detection of *Bartonella* organisms in dogs and humans will be provided. Lastly, the potential link between bacterial infection and cancer will be reviewed.

Bartonella bacilliformis

History. *Bartonella bacilliformis* is a human pathogenic organism that was the only member of the genus prior to the taxonomic changes in 1993. Although demonstrated graphically in pre-Incan ceramics and monoliths, *B. bacilliformis* was not implicated in human disease until the late 19th century (Alexander 1995; Maguiña et al., 2000).

Between 1869 and 1873, approximately 8,000 of 10,000 railway workers in the Andes mountain region of Peru died with acute hemolytic anemia, the acute form of *B.*

bacilliformis infection known as Oroya fever (Bass et al., 1997a; Ihler 1996).

Human bartonellosis, a term traditionally used to describe infection with *B. bacilliformis*, is a biphasic disease; the acute phase includes Oroya fever, a life-threatening febrile anemia, which is often followed by the chronic stage of verruga peruana, a disorder characterized by vasoproliferative eruptions of the skin. The infectious association between Oroya fever and verruga peruana was not recognized until 1885, when a Peruvian medical student, Daniel Carrión, inoculated himself with blood from a verruga skin lesion, the chronic disease form. After 39 days, Carrión developed severe febrile anemia, the acute stage of the disease, and subsequently died (Bass et al., 1997a; Maguiña et al., 2000). The disease is often referred to as Carrion's disease to honor his important contribution. In the early 1900s, Dr. Alberto Barton, an Argentinian microbiologist working in Peru,

observed intraerythrocytic bacilli in blood smears of patients suffering with Carrion's disease; the causative agent, *Bartonella bacilliformis*, is named in his honor (Bass et al., 1997a; Maguiña et al., 2000).

Transmission. Early entomological studies hypothesized that the sand fly, *Phlebotomus verrucarum*, now *Lutzomyia verrucarum*, was the potential vector of *B. bacilliformis* (Townsend 1914). It was suspected that the limited distribution of this vector resulted in the restricted geographic distribution of the disease (Maguiña et al., 2000). However, recent outbreaks of Oroya fever in non-endemic regions where *L. verrucarum* is not the primary sand fly species suggest other *Lutzomyia* species or other arthropods can serve as potential vectors of *B. bacilliformis* in non-endemic areas (Alexander 1995; Ellis et al., 1999b). To date, no nonhuman vertebrate reservoir for *B. bacilliformis* has been recognized.

Clinical presentation. *Bartonella bacilliformis* infection results in a biphasic disease characterized by severe anemia followed by vasoproliferative skin lesions. Once bitten by an infected sand fly, *B. bacilliformis* organisms invade and multiply in vascular endothelial cells; after cell lysis, these organisms can invade other endothelial cells and circulating erythrocytes (Maguiña et al., 2000). After an estimated incubation period ranging from 7 to 100 days, the acute phase of the disease, Oroya fever, develops and results in gradual, nonspecific symptoms, such as malaise, fever, and headache. The most

common clinical presentation is severe and life-threatening hemolytic anemia, which results from erythrocytic invasion and lysis by *B. bacilliformis*.

Onset of the chronic disease form, verruga peruana, may vary from weeks to months and is characterized by the appearance of nodular lesions of various sizes on the skin and mucous membranes (Maguiña et al., 2000). These eruptions are small, painless, colorless or purplish-red, and prone to bleeding, secondary infection, and ulceration; clinically, verruga peruana may resemble bacillary angiomatosis, as caused by *B. henselae* and *B. quintana*, Kaposi's sarcoma, malignant lymphoma, and hemangioma.

Recent epidemiological data. Reports in the literature indicate that *B. bacilliformis* infection is found only in regions of Peru, Ecuador, and Colombia. This limited geographic distribution is a direct reflection of the ecologic niche of the primary sand fly vector, *L. verrucarum*. Children in endemic areas may present with a mild, acute form of the disease or be relatively asymptomatic; it is often people not native to the region who develop acute, severe forms of the disease (Maguiña et al., 2000). The fatality rate of Oroya fever, estimated at 90% if untreated, is dramatically reduced to less than 10% with prompt and appropriate antibiotic therapy.

Recent data from a population-based, prospective cohort study (n = 690) performed in a *B. bacilliformis*-endemic Peruvian community demonstrated that 0.5% of study participants had asymptomatic bacteremia at the start of the study; after two years, the incidence of infection was 12.7/100 person-years (Chamberlin et al., 2002). The study noted that the highest infection rates were recorded in children less than five years old, and

an inversely proportional relationship was observed between the incidence of infection and age. Further, 70% of cases were clustered in 18% of surveyed households, and age and infection in a family member were the best predictors of *B. bacilliformis* infection.

Bartonella quintana

History. *Bartonella quintana* was a primary and devastating cause of infectious morbidity among troops during World War I and was estimated to have affected more than one million people (Raoult et al., 1999). Known as trench fever, the disease is characterized by intraerythrocytic bacteremia coupled with a five-day relapsing fever, headache, generalized myalgia, and severe bone and joint pain, often resulting in sustained disability (Bass et al., 1997a; Rolain et al., 2002). Outbreaks during warfare were attributed to soldiers living together in overcrowded, unhygienic conditions, and clinical symptoms generally occurred in the winter. These observations suggested an arthropod vector was involved in transmission. Research conducted during the World War I era demonstrated that the clinical symptoms of trench fever were observed after allowing body lice to feed on human patients (Swift 1920). Further, the organism of trench fever, then referred to as a virus, was transmitted to non-infected patients through several routes: by escharification of the skin, via injection into subcutaneous tissue with infected louse feces, or when dried urine and dried sputum and saliva from infected individuals were rubbed into scarified areas of skin of healthy volunteers (Bruce 1921). Within five days of feeding on a person infected with trench fever, the excreta from the body louse also became

infectious (Bruce 1921). This finding has been corroborated with more recent research indicating that dry fecal material from *B. quintana*-infected lice can remain infectious for several months, resulting in an important mechanism for disease transmission (Bass et al., 1997a). The incidence of trench fever diminished considerably after World War I; however, outbreaks were also reported during World War II, and the successful isolation of the causative agent of trench fever, *B. quintana*, was not reported until 1961 (Vinson et al., 1961). Nearly forgotten after World War II, a recent re-emergence of *B. quintana* infections, referred to as urban trench fever, have been reported in homeless, poverty-stricken populations in Europe and the United States (Fournier et al., 2002b; Jackson et al., 1996a; Jackson et al., 1996b; Koehler et al., 1997; Spach et al., 1998).

Transmission. Historically, humans were the only known reservoir host for *B. quintana*, and the human body louse (*Pediculus humanus*) was the only known vector. Similar to sand fly transmission of *B. bacilliformis*, little research regarding louse transmission of *B. quintana* has been published in recent years. Upon infestation, *B. quintana* organisms proliferate in the vector's intestine and are transmitted to humans when the infected louse excreta enter the skin, typically through scratching.

It has been hypothesized that the human body louse is not the only vector for *B. quintana* (Foucault et al., 2006). In the current literature, *B. quintana* DNA has been found in ticks and cat fleas (Chang et al., 2001; Rolain et al., 2003a). Further, *B. quintana* was isolated from a healthy, captive-bred cynomolgus monkey (*Macaca fascicularis*) (O'Rourke et al., 2005), and *B. quintana* DNA was amplified from two dogs with

endocarditis (Kelly et al., 2006), a cat euthanized for reasons unrelated to infectious diseases (La et al., 2005), and from feral farm cats that presumably induced *B. quintana* infection in a woman by bite transmission (Breitschwerdt et al., 2007). Considering these data, it is possible that vectors other than the human body louse can effectively maintain infection with *B. quintana* and are able to transmit the organism; additionally, nonhuman primates, dogs, and cats may serve as reservoir hosts.

Clinical presentation. *Bartonella quintana* causes a wide range of clinical manifestations including trench fever, chronic bacteremia, endocarditis, lymphadenopathy, and bacillary angiomatosis. Trench fever is the acute presentation of *B. quintana* infection, and disease states range from subclinical to severe, life-threatening illness (Foucault et al., 2004). Classic trench fever, also known as five-day fever for the periodic nature of febrile relapses, is characterized by severe headache, dizziness, and pain in the legs, primarily the shinbones.

Patients infected with *B. quintana* may also develop a persistent bacteremia. Reports from research conducted during World War I demonstrated that approximately 5 to 10% of trench fever patients remained symptomatic for months to years after the initial illness (Swift 1920). In recent data, chronic bacteremia was detected in 16 of 42 (38.1%) asymptomatic patients with positive blood cultures; bacteremia continued for 78 weeks in a single patient, for 53 and 17 weeks in two patients, and for up to eight weeks in the other 13 patients. Further, four additional patients had inconsistent bacteremia, over periods of four to 58 weeks, as indicated by intermittently positive blood cultures (Foucault et al.,

2002). It should be noted that patients with protracted bacteremia have been shown to produce little to no detectable antibody response to *B. quintana* when tested using an indirect immunofluorescence antibody (IFA) test (Brouqui et al., 1999) or have been completely non-seroreactive although blood- or bone marrow-culture positive (Drancourt et al., 1996; La Scola et al., 1999). Conversely, other studies have found that bacteremia was significantly associated with *B. quintana* seroreactivity. For example, 26 of 40 (65%) bacteremic, homeless individuals had reciprocal *B. quintana* antibody titers of ≥ 100 compared to only 16 of 82 (19.5%) *B. quintana* blood-culture negative, homeless persons (odds ratio [OR] = 7.66, 95% confidence interval, 3.03 to 19.71); further, bacteremic patients (9/40, 22.5%) had higher (≥ 800) IFA titers when compared to controls (2/82, 2.4%) (OR = 11.61, 95% CI, 2.18 to 113.80) (Foucault et al., 2002).

Bartonella quintana-associated endocarditis is most often observed in immunocompetent homeless people with chronic alcohol abuse and extensive exposure to body lice (Drancourt et al., 1995; Fournier et al., 2001). Unlike the endocarditis caused by *B. henselae* infection, *B. quintana*-endocarditis patients typically have no previously known valvular damage (Fournier et al., 2001). It should be noted that although not definitively linked, *Bartonella* endocarditis is likely attributed to chronic, persistent bacteremia (Fournier et al., 2001). In general, *Bartonella* endocarditis is persistently blood-culture negative, which often results in delayed diagnoses and a higher mortality rate when compared to other forms of bacterial, infective endocarditis. In a recent study, 28% (99/348 cases) of blood-culture negative endocarditis cases were attributed to *Bartonella* bacteria using serological, molecular, or microbiological methods (Houpikian et al., 2005).

Similar to humans, *Bartonella* endocarditis has also been reported in dogs; however, unlike humans, bacterial endocarditis is an uncommon, often fatal disease in dogs. In a prospective study of dogs in northern California, *Bartonella* species bacteria were the most common cause of endocarditis and were involved in 28% (5/18 cases) of canine endocarditis cases during a two-year period (MacDonald et al., 2004). Further, four of these five cases were blood-culture negative despite the use of *Bartonella*-specific culture methods. While endocarditis in dogs has been ascribed to other *Bartonella* species (Breitschwerdt et al., 1999; Chomel et al., 2001; Chomel et al., 2003), the first description of *B. quintana* endocarditis in two dogs, as evidenced by molecular techniques, Warthin-Starry staining, and immunohistochemical analysis, was recently reported (Kelly et al., 2006). Other than these two dogs with *B. quintana* endocarditis, there are no reports of *B. quintana* infection in dogs.

In humans, *B. quintana* has been reported as a cause of granulomatous lymphadenopathy in two patients, one diagnosed by a positive blood culture, the second from a bone marrow biopsy specimen (Drancourt et al., 1996; Raoult et al., 1994). Further, *B. quintana* infection was detected, using molecular techniques, in two patients with central nervous system disease, one with a focal granulomatous process involving the right thalamus and adjacent structures and the other with encephalopathy; however, seroreactivity to *B. quintana* was not detected in either patient (Parrott et al., 1997).

Bacillary angiomatosis is often observed in immunocompromised individuals, primarily HIV-infected patients, and may be induced by *B. quintana* or *B. henselae* (Brouqui et al., 2006; Koehler et al., 1997). Several different organs may be affected, such

as the liver, spleen, bone marrow, and lymph nodes; however, bacillary angiomatosis most often affects the skin, and the lesions are similar to those of *B. bacilliformis*-associated verruga peruana (Koehler et al., 1997; Maurin et al., 1996). Bacillary angiomatosis may be life threatening in untreated patients (Foucault et al., 2006).

Altogether, these findings indicate that the immune status of the host, including any disruption in the immune response, may strongly influence disease severity, degree of clinical manifestation, particular histopathologic response, and diagnostic detection of the organism (Breitschwerdt et al., 2000; Kordick et al., 1995).

Recent epidemiological data. A re-emergence of *B. quintana* infections have been recently reported in homeless populations in Marseille, France, the Netherlands, and various countries in Africa (Fournier et al., 2002b), Tokyo, Japan (Sasaki et al., 2002), rural Andean communities (Raoult et al., 1999), Moscow, Russia (Rydkina et al., 1999), and in the United States in Seattle, Washington (Jackson et al., 1996a) and San Francisco, California (Koehler et al., 1997). The major predisposing factors for these recent outbreaks in urban areas include poverty, unhygienic living conditions, and chronic alcohol abuse (Spach et al., 1995).

In an earlier study assessing *B. quintana* seroreactivity and bacteremia in homeless persons presenting to emergency rooms in Marseilles, France, researchers found that 30% (21/71 patients) of tested patients had detectable antibody titers to *B. quintana* and 14% (10/71 patients) were bacteremic (Brouqui et al., 1999). In Seattle, Washington, a similar serosurvey was conducted in the homeless population; when *B. quintana* serological titers

were compared to 199 age- and sex-matched local volunteer blood donors, 20% (39/129) of clinic patients were seroreactive versus only 2% (4/199) of blood donors ($p < 0.001$) (Jackson et al., 1996b). Additional data were collected from homeless people with *B. quintana* bacteremia (n = 42) and homeless people with negative blood culture results (n = 84, used as controls) who presented for ambulatory care at the University Hospital in Marseilles, France. When compared to controls, *Bartonella* bacteremia was associated ($p \leq 0.05$) with sweats (OR = 5.79, 95% confidence interval, 1.18 to 36.67), evidence of louse infestation (2.75, 1.14 to 6.65), and being homeless for less than 3 years (14.17, 2.52 to 96.06) (Foucault et al., 2002).

Approximately 20% (68/382 patient) of febrile patients presenting to San Francisco Bay-area hospitals demonstrated evidence of *Bartonella* infection by molecular, serological, or microbiological methods; all patients who were culture and/or PCR positive for *Bartonella* were concurrently infected with HIV (Koehler et al., 2003). In another study of San Francisco Bay-area residents, 49 patients with confirmed *B. henselae* or *B. quintana* infections and clinical lesions consistent with bacillary angiomatosis and bacillary peliosis were enrolled in a case-control study; another 96 participants, matched by age, sex, race, and HIV-serologic status, served as controls (Koehler et al., 1997). More than half of the enrolled cases (26/49, 53%) were infected with *B. henselae*, while the remaining patients were infected with *B. quintana* (23/49, 47%). When comparing these two groups, differences were observed in the distribution of the vasoproliferative lesions in specific patient tissues; subcutaneous and bone lesions were associated with *B. quintana* infection, while lymph node and hepatosplenic lesions were found exclusively with *B.*

henselae. When compared to matched controls, cases with *B. quintana* infections were characterized by exposure to body lice (OR undefined, $p = 0.03$), low annual income (9.8, 2.0 to 47.3, $p = 0.003$), and homelessness (8.5, 1.8 to 40.3, $p = 0.004$). Additionally, epidemiological differences were noted in cases infected with *B. henselae*; these cases were significantly more likely to have owned a cat (OR = 10.8, 2.0 to 56.7, $p = 0.004$), been bitten or scratched by a cat (6.2, 2.0 to 18.8, $p = 0.001$), owned a cat with fleas (OR undefined, $p < 0.001$), or been bitten by cat fleas (11.9, 3.0 to 49.8, $p < 0.001$).

In a case series of 348 blood culture-negative endocarditis patients, 99 (99/348, 28%) total cases had serological, microbiological, or molecular evidence of infection with a *Bartonella* species; 98 of 99 (98.9%) were diagnosed by IFA serology, 3 of 99 (3.03%) were diagnosed by blood culture, and 49 of 99 (49.5%) were diagnosed by culture and/or PCR on the affected heart valve (Houpikian et al., 2005). Of the 49 cases positive by culture and/or PCR, 38 were infected with *B. quintana*, 10 with *B. henselae*, and one with *B. vinsonii (berkhoffii)*. When serological and molecular data were combined, *B. quintana*-associated endocarditis (53 cases) was observed more frequently than *B. henselae* endocarditis (17 cases).

In dogs, it has been shown that infection with *Bartonella* species adversely affects the clinical outcome of endocarditis (MacDonald et al., 2004; Sykes et al., 2006). In a prospective study, five of 18 dogs (27.7%) were diagnosed with *Bartonella*-associated endocarditis during a two-year period (MacDonald et al., 2004). All five of the *Bartonella* endocarditis dogs died due to rapid development of congestive heart failure, cardiac arrhythmias, or complications from thromboembolism. When Kaplan-Meier curves were

constructed, the median and mean survival times of dogs with endocarditis due to *Bartonella* were three days (95% CI = 0 to 8.4 days) and 45 days (95% CI = 0 to 126 days), respectively, compared with significantly ($p = 0.01$) longer median (330 days, 95% CI = 0 to 664 days) and mean (375 days, 95% CI = 193 to 557 days) survival times in non-*Bartonella* endocarditis cases (MacDonald et al., 2004). More recently, it has been suggested that the previously reported incidence of 28% may be a substantial underestimation of the true incidence of *Bartonella*-associated endocarditis in dogs. As shown in a retrospective case series of canine endocarditis data, seven of 28 (25%) dogs diagnosed with endocarditis of unknown cause from 2001 to 2005 were not tested for *Bartonella* (Sykes et al., 2006). Further, when the clinical features of dogs with endocarditis ($n = 71$) were retrospectively reviewed, dogs with *Bartonella*-associated endocarditis were often afebrile ($p = 0.03$), more likely to develop congestive heart failure ($p = 0.004$), and had shorter survival times ($p = 0.008$; hazard ratio = 2.72, 95% CI, 1.57 to 18.82) when compared to dogs with endocarditis attributed to bacteria other than *Bartonella* (Sykes et al., 2006).

Bartonella henselae

History. Although the first clinical description of cat scratch disease (CSD) was reported in 1950 (Debré et al., 1950), its bacterial etiology was not established until 1983 when small, gram-negative bacilli were identified by Warthin-Starry silver stain in lymph node biopsies of CSD patients (Wear et al., 1983). In 1988, the probable etiologic agent

was isolated from lymph nodes of patients with CSD, and following characterization, the bacterium was named *Afipia felis* (Brenner et al., 1991; English et al., 1988). However, subsequent serological and molecular research failed to provide a solid causal relationship between *A. felis* and the majority of CSD cases (Amerein et al., 1996; Bergmans et al., 1995; Patnaik et al., 1995; Szelc-Kelly et al., 1995).

Only with the onset of the HIV/AIDS epidemic was *B. henselae* successfully identified as the etiologic agent of CSD. Bacillary angiomatosis, observed in HIV-infected individuals, was attributed to a novel gram-negative bacterium that was closely related to *B. quintana*; subsequently, this new bacterium was isolated from a febrile HIV patient and was named *B. henselae* (Regnery et al., 1992a; Relman et al., 1990). Ultimately, *B. henselae* organisms were discovered in tissues from both CSD and bacillary angiomatosis patients (LeBoit et al., 1988; Wear et al., 1983), and serological tests indicated that both patient groups had elevated titers to *B. henselae* (Regnery et al., 1992b). The etiological role in CSD was further supported by molecular analyses used to identify *B. henselae* in CSD skin test antigen preparations (Anderson et al., 1993) and culminated in the subsequent isolation of *B. henselae* from the lymph nodes of patients with CSD (Dolan et al., 1993). Currently, *B. henselae* is considered to be the most common bacterial, zoonotic pathogen acquired from companion animals (Iredell et al., 2003).

Clinical presentation. Cat scratch disease is the most widely recognized manifestation of *B. henselae* infection, and although reported in patients of all ages, CSD is most commonly observed in persons less than 20 years of age and in persons who own a

flea-infested kitten (Chomel et al., 2006). In stark contrast to immunocompromised patients with bacteremia, recurrent fever, or vasoproliferative disorders, classic CSD, as caused by *B. henselae*, is often a self-limiting infection in a healthy host and is characterized by a benign regional lymphadenopathy. Atypical manifestations of *B. henselae* infection have been reported to occur in 5 to 15% of cases and include Parinaud's oculoglandular syndrome, encephalopathy, endocarditis, and osteolytic lesions (Chomel et al., 2004; Houpiikian et al., 2005; Maurin et al., 1997; Noah et al., 1995). *Bartonella henselae* has recently been associated with prolonged fever or fever of unknown origin (CDC 2002; Jacobs et al., 1998; Tsujino et al., 2004; Tsukahara et al., 2000) and Henoch-Schonlein purpura (Ayoub et al., 2002; Robinson et al., 2005) primarily in children, along with various types of ocular lesions such as uveitis and neuroretinitis (Cunningham et al., 2000; Drancourt et al., 2004; Mason 2004; Ormerod et al., 1999).

Bartonella henselae infection in immunocompetent humans has also been shown to mimic lymphoma (Ghez et al., 2001; Wong et al., 1996) or breast cancer (Chess et al., 1990; Dawson et al., 1987; Fortune et al., 2000; Godet et al., 2004; Lefkowitz et al., 1989; Markaki et al., 2003). Atypical cat scratch disease cases have been shown to present with abdominal symptoms and imaging findings that are indistinguishable from lymphoma. In one case, masses in the liver and spleen were observed upon ultrasound and contrast-enhanced computed tomography, however, the presence of painful and tender lymph nodes suggested an infectious etiology, as tenderness is rarely observed in lymphadenopathy related to lymphoma (Wong et al., 1996). Multiple biopsy specimens indicated no evidence of lymphoma, and subsequently, a *B. henselae* reciprocal antibody titer of 11,395

and a positive PCR result lead to the diagnosis of cat scratch disease (Wong et al., 1996). A second case of *B. henselae* infection mimicking lymphoma was reported in a patient with enlarged abdominal lymph nodes and heterogeneous splenomegaly, as demonstrated by ultrasound evaluation (Ghez et al., 2001). *Bartonella henselae* infection was confirmed by IFA serological analyses; following 2 weeks of antibiotic therapy, a computed tomography scan of the abdomen demonstrated complete resolution of the splenic lesions and a generalized reduction in lymphadenopathy (Ghez et al., 2001). Atypical *B. henselae* infections presenting as a solitary mass in the breast, have been mistaken for breast carcinomas. In a recent case series, three women, each with a palpable breast mass and enlarged axillary lymph nodes, had biopsies performed on the small intraparenchymal breast lesions (Markaki et al., 2003). Microscopic examination of these samples indicated a granulomatous reaction in the breast tissue and the lymph nodes, and Warthin-Starry staining bacteria were present in the areas of central necrosis and in macrophages (Markaki et al., 2003). Lastly, molecular analysis was used to diagnose *B. henselae* infection in another case of a breast mass, suggestive of adenoma, and presenting with inflammatory lymphadenopathy (Godet et al., 2004). When serological testing was negative, PCR detected *B. henselae* in a lymph node aspirate, and antibiotic treatment successfully resolved all clinical signs (Godet et al., 2004).

In immunocompromised patients with *B. henselae* infection, vasoproliferative lesions are most often observed within the lymph nodes or as peliosis hepatis, a rare hepatic lesion, and risk factors for infection include exposure to cats and cat fleas (Koehler et al., 1997; Perkocha et al., 1990; Reed et al., 1992; Slater et al., 1992). Although more

commonly observed in an HIV-infected host, a few reports of bacillary angiomatosis in immunocompetent patients have been reported (Cockerell et al., 1990; Karakas et al., 2000; Paul et al., 1994; Tappero et al., 1993a; Turgut et al., 2004). It should be noted that peliosis hepatis has also been observed in a dog with *B. henselae* infection, as documented by PCR analysis of the affected liver tissue (Kitchell et al., 2000).

Endocarditis may represent the most prevalent, newly recognized disease process associated with *Bartonella* infection in immunocompetent humans and in dogs. In 1993, three separate reports of *Bartonella*-induced endocarditis in human patients were reported, one case each ascribed to *B. quintana*, *B. elizabethae*, and *B. henselae* (Daly et al., 1993; Hadfield et al., 1993; Spach et al., 1993). Although the 1993 report of *B. elizabethae* endocarditis represents the only known case, *B. quintana* and *B. henselae* have been detected by molecular or microbiological methods in 49 of 348 (14.1%) blood culture-negative endocarditis patients surveyed in Europe (Houpikian et al., 2005). Importantly, it was recently reported that the development of endocarditis was much more likely in elderly patients (≥ 60 years old) with CSD when compared to younger CSD patients (< 60 years old) (OR = 61.6, 95% CI, 12.4 to 305.1) (Ben-Ami et al., 2005). Due to the fastidious nature of the organism and the difficulties associated with the culture of *Bartonella*, serological analyses, such as IFAs, have been utilized successfully in the diagnosis of *Bartonella* endocarditis; further, high titers have been positively predictive of *Bartonella* endocarditis in humans (Fournier et al., 2002a; Raoult et al., 1996; Wesslen et al., 2001), and data suggest a similar relationship in dogs (Breitschwerdt et al., 1999; MacDonald et al., 2004; Pesavento et al., 2005).

Although historically relegated to cats and humans, several case reports of *B. henselae* infections in dogs have been documented. Recently, *B. henselae* DNA has been amplified and confirmed by DNA sequencing in the liver of a dog with peliosis hepatis (Kitchell et al., 2000) and a dog with granulomatous hepatitis (Gillespie et al., 2003), from the blood of three dogs with various, nonspecific clinical abnormalities including fever, protracted lethargy, anorexia, thrombocytopenia, or neurologic dysfunction (Mexas et al., 2002), and from the blood of a dog with epistaxis (Breitschwerdt et al., 2005). Lastly, two dogs with pyogranulomatous lymphadenitis and diverse clinical syndromes were shown to have molecular evidence of *B. henselae* infection within the affected lymph nodes and peripheral blood (Morales et al., 2007).

Transmission. The domestic cat has been shown to be the primary reservoir for *B. henselae*, and in natural and experimental infections, the cat flea (*Ctenocephalides felis*) has been shown to act as the principal vector (Chomel et al., 1995). However, as the primary reservoir host, it is hypothesized that cats infected with *B. henselae*, although chronically bacteremic, may lack clinical signs of illness (Bass et al., 1997b; Bergmans et al., 1997; Chomel et al., 1995; Jameson et al., 1995).

In humans, CSD patients were more likely than healthy, age-matched cat owners to have a kitten, been scratched or bitten by a kitten, or to have a kitten infested with fleas (Zangwill et al., 1993). Additionally, fleas collected from bacteremic cats owned by *B. henselae*-bacillary angiomatosis patients were positive for *B. henselae* by PCR and culture (Koehler et al., 1994). In an experimental study, Chomel et al. (1996) definitively

established the role of *C. felis* in the transmission of *B. henselae* by demonstrating that *B. henselae* could be successfully transmitted to specific pathogen free cats using fleas collected from bacteremic cats. Additional studies have demonstrated that *Bartonella* organisms remain reproductively viable in flea feces. For example, *B. henselae* has been detected in cat fleas as early as three hours after feeding on infected cat blood, has been shown to replicate in the flea midgut, and was continuously excreted in flea feces up to nine days post-feeding (Higgins et al., 1996); further, infected flea feces have been used successfully to transmit *B. henselae* to cats (Foil et al., 1998). Considering these data, transmission of *B. henselae* to humans may occur through direct inoculation from a flea bite, but more likely occurs by inoculation of *B. henselae*-contaminated flea feces into the skin by way of a bite or scratch from a flea-infested cat (Finkelstein et al., 2002).

Bartonella henselae has been reported in several new vectors including ticks (Adelson et al., 2004; Chang et al., 2001; Eskow et al., 2001; Holden et al., 2006; Morozova et al., 2004; Sanogo et al., 2003) and biting flies (Chung et al., 2004; Reeves et al., 2006), thereby providing alternate means of transmission. Early epidemiological evidence indicated that tick exposure may be a risk factor for *B. henselae* infection (Lucey et al., 1992), a hypothesis further supported by a case-control study indicating that CSD patients were approximately six times more likely to be exposed to ticks when compared to healthy cat owners (Zangwill et al., 1993). Using PCR with confirmation by DNA sequencing, questing *Ixodes pacificus* ticks in California were shown to harbor *B. henselae*, *B. quintana*, and *B. vinsonii (berkhoffii)*; in addition, a single tick was co-infected with *B. henselae* and *B. vinsonii (berkhoffii)* (Chang et al., 2001).

Recent epidemiological data. A massive amount of literature, including case reports, case series, and other patient compilations, has been published pertaining to *B. henselae* infection in humans; these data have been collected from both immunocompromised and immunocompetent individuals, from patients of all ages and socio-economic backgrounds, with and without the CSD-associated lymphadenopathy, and various other clinical conditions. This brief review will focus on several, larger case series, not discussed elsewhere within this chapter^o, with a concentration on research-related interests.

In a recent study designed to define the frequency of *B. henselae* in French CSD patients, 245 of 786 (31.2%) lymph node biopsy samples were PCR positive for *B. henselae* DNA, while only one successful *B. henselae* isolation was reported (Rolain et al., 2006). Additionally, the presence of *B. henselae* in the lymph nodes of CSD patients was confirmed using direct immunofluorescence detection coupled with monoclonal antibodies directed to *B. henselae* (Rolain et al., 2003b); this technique was used on 216 lymph node smears collected from *Bartonella*-positive patients, and 166 (166/216, 76.9%) were positive for *B. henselae* (Rolain et al., 2006). Further, 13 of 245 CSD patients (5.3%) had a concurrent lymph node disease, 10 with mycobacteriosis and three with neoplasia, thereby suggesting that CSD diagnosis does not preclude a concurrent diagnosis of mycobacteriosis or neoplasia.

A study of 454 patients with lymphadenopathy of the head and neck of unknown etiology demonstrated that 156 (34.4%) patients had infectious disease diagnoses, 75

(16.5%) had benign disorders, and 52 (11.5%) had malignant neoplasms, while 171 (37.7%) remained undiagnosed (Ridder et al., 2002). Sixty-one of 454 (13.4%) patients were diagnosed serologically with *B. henselae*-associated CSD. In nearly 40% of these patients (23/61 patients), lower reciprocal IgG titers (< 512) were detected at the time of initial examination, while higher titers (up to 8,192) were observed two to 16 weeks after the onset of illness. *Bartonella henselae* infection was confirmed by PCR in 10/21 (48%) lymph node samples, including needle aspirates or excised tissue, collected from 21 of 61 CSD patients. Further, nine of 10 lymph node samples were PCR positive up to six weeks after the onset of illness. Microbiological isolation of *B. henselae* from lymph node tissue and bacterial observation using Warthin-Starry silver staining were unsuccessful in these CSD patients. When tested against *B. henselae* antigens, nearly one-third of the patients without CSD were seroreactive to *B. henselae* (111/393, 28.2%); however, *Bartonella* DNA was not detected in the 11 lymph node specimens available for PCR from these non-CSD patients.

Several important findings resulted from the Ridder et al. (2002) research: (1) in the early stages of CSD, antibody titers (IgG and IgM) may be lower than expected and an appropriate CSD diagnosis can only be confirmed with increasing serological titers (typically a 4-fold increase) in a convalescent sample; (2) should serological results fail to confirm the CSD diagnosis, other diagnostic procedures including PCR analyses of the lymph node tissue, are suggested; and (3) PCR results may depend greatly on the duration of illness, as evidenced by *B. henselae* amplification only in lymph nodes obtained during the first six weeks of disease. The authors stated that similar PCR results were confirmed

in an animal model of CSD; however, these results were not provided. Also of note, four patients with malignant tumors, as determined by histopathological analyses of the lymph node tissues, had high antibody titers against *B. henselae* (≥ 512). Although patient histories and clinical findings were not suggestive of CSD, the authors attribute these four cases to concurrent *B. henselae* infection and malignant neoplasia.

In an Israeli surveillance study, less than 3% (24/841 patients) of CSD cases developed the atypical disease manifestation of severe and disabling arthropathy (arthritis, arthralgia, or both) (Giladi et al., 2005). When these 24 patients were compared to 817 CSD patients without articular disease, multivariate analyses identified three variables significantly ($p < 0.05$) associated with arthropathy: female sex (relative risk [RR] = 2.5; 95% CI, 1.01 to 6.32), age older than 20 years (4.9, 1.96 to 12.4), and erythema nodosum (7.9, 2.34 to 26.41). Although the majority of patients (19/24, 79.2%) recovered after six weeks (range, 1 to 24 weeks), five patients (20.8%) developed chronic disease persisting 16 to 53 months (median, 30 months).

Perhaps the single most recognized and certainly the most frequently reported human vector-associated disease in the United States is Lyme disease, caused by the bite of a *Borrelia burgdorferi*-infected Ixodid tick. Like *Bartonella* infections, a long and diverse list of clinical signs are often observed in Lyme disease and may include acute symptoms such as fever, headache, fatigue, and more chronic disease manifestations of arthritis and a nervous system disorder termed neuroborreliosis. In a case series from the Lyme-endemic region of New Jersey, four patients with clinical signs and symptoms related to chronic Lyme disease were evaluated for *Bartonella* co-infection (Eskow et al., 2001). All four

patients had been treated previously and extensively with *Borrelia*-specific antibiotics with no resolution in clinical signs or symptoms. Despite the lack of clinical CSD manifestations, all patients were seroreactive to *B. henselae*, and *B. henselae* DNA was amplified from the peripheral blood in these patients. Additionally, PCR analyses of the cerebrospinal fluid were positive for both *B. henselae* and *Borrelia burgdorferi*.

In the last decade, *Bartonella* species were detected predominantly in patients with immune impairments, in CSD patients, or in patients with endocarditis. However, recent reports indicating that *Bartonella* may be involved in the sudden, unexpected, cardiac deaths of 16 seemingly healthy, Swedish orienteers have greatly changed the scope of *Bartonella* infections in clinically healthy individuals. Orienteering is a physically demanding, competitive sport in which an accurate, detailed map and a compass are used to find points in the landscape. During a period from 1979 to 1992, a 10- to 100-fold increase in the incidence of sudden, unexpected, cardiac death was observed in Swedish male orienteers who were 35 years of age and competing at the elite level (Larsson et al., 1999; Wesslen et al., 1996). When these athletes were examined at autopsy, morphological changes were consistent with myocarditis in the majority of cases (Wesslen et al., 1996). Based on the association of *Bartonella* and endocarditis, myocarditis, and cardiac arrhythmias in both dogs and humans, researchers began investigating whether *Bartonella* organisms may be involved in these sudden deaths. While serological analyses demonstrated the highest seroreactivity to *B. elizabethae*, a rodent-borne *Bartonella* species, PCR of autopsy tissues from five deceased orienteers demonstrated *B. henselae* or *B. quintana* DNA in four of five heart tissues and one lung tissue tested (McGill et al.,

2001; Wesslen et al., 2001). No serologic or molecular evidence of *Bartonella* infection was detected in the heart tissue of six males who died of trauma and served as controls. The authors suggest that infection with *Bartonella* induced silent, subacute myocarditis, eventually resulting in electric instability and the increased sudden, unexpected, cardiac death rate among the Swedish orienteers.

Much of the recent literature for *B. henselae* in dogs is focused on serosurveys and the risk factors and clinical signs associated with seroreactivity. A Hawaiian serosurvey reported two of 31 (6.5%) dogs surveyed were seroreactive to *B. henselae*, both with very low IFA reciprocal titers of 64 and 128; however, blood cultures were negative and no PCR analyses were performed (Demers et al., 1995). In Japan, four of 52 (7.7%) dogs surveyed were *B. henselae* seroreactive, and *B. henselae* DNA was amplified by PCR in blood, nail clippings, and oral swabs collected from 15% of the dogs studied (Tsukahara et al., 1998). Only 3% (3/100 dogs) of the dogs in the United Kingdom were *B. henselae* seroreactive (Barnes et al., 2000). In a serosurvey of dogs from the southeastern United States, 27.2% (82/301 dogs) of sick dogs and 10.1% (10/99 dogs) of healthy dogs were seroreactive to *B. henselae* antigens (Solano-Gallego et al., 2004). A Californian serosurvey of 3,417 sick dogs demonstrated that only 1.1% (36/3,417 dogs) of dogs were *B. henselae* seroreactive (Henn et al., 2005); conversely, the seroprevalence of antibodies against *B. henselae* in clinically healthy dogs was 14% (32/228 dogs) in Zimbabwe (Kelly et al., 2004).

In a case-control study to evaluate *B. henselae* seroreactivity in dogs, no significant differences were noted in clinical and clinicopathologic findings in 40 dogs seroreactive to

B. henselae when compared to 45 non-seroreactive dogs (Goodman et al., 2005). It is important to note, however, that *B. henselae* seroreactivity was detected in two of four dogs with granulomatous meningoencephalitis, three of four dogs with immune-mediated hemolytic anemia, three of four dogs with infective endocarditis, two of three dogs with lymphoid neoplasia, five of 10 dogs with polyarthritis, 18 of 34 dogs with thrombocytopenia, and 14 of 27 dogs with neutrophilia.

In a case-control study conducted as a component of a *B. vinsonii* (*berkhoffii*) serosurvey, dogs that were seroreactive to *B. henselae*, *B. vinsonii* (*berkhoffii*), and/or *B. clarridgeiae* antigens were compared to 203 non-seroreactive dogs matched by age and date of evaluation; statistical models were developed to assess risk factors and clinical signs associated with *Bartonella* seroreactivity (Henn et al., 2005). In a conditional logistic regression model, herding-type dogs were more likely to be *Bartonella* seroreactive when compared to sporting-breed dogs (OR = 2.23; 95% CI, 1.11 to 4.48), and toy breeds were less likely to be seroreactive (0.26, 0.08 to 0.80); further, female dogs were more likely to be *Bartonella* seroreactive when compared to males (1.68, 1.02 to 2.76). Various clinical signs were observed in the 102 seroreactors including lymphadenopathy, vomiting, and neoplasia; however, upon statistical evaluation using a multivariate conditional logistic regression model, *Bartonella* seroreactive dogs were more likely to present with lameness (2.23, 1.00 to 4.97), arthritis-related lameness (2.72, 1.07 to 6.90), nasal discharge or epistaxis (10.10, 1.12 to 91.0), and/or splenomegaly (4.27, 1.05 to 17.5).

Bartonella elizabethae

History. In 1993, a fastidious gram-negative bacterium was isolated from blood cultures of an immunocompetent human patient with valvular endocarditis; DNA homology and 16S rRNA sequence comparisons demonstrated similarity to other *Bartonella* species, and the new strain was designated *B. elizabethae* (Daly et al., 1993). This 1993 description constitutes the only reported isolation of *B. elizabethae*, although other serological and molecular evidence of infection exists.

Clinical presentation. *Bartonella elizabethae* is known to induce human endocarditis (Daly et al., 1993), and *B. elizabethae* antibodies have been detected in several Swedish orienteers with myocarditis followed by sudden, unexpected, cardiac death (McGill et al., 2001). Seroreactivity to *B. elizabethae* was also reported in patients with neuroretinitis and myocarditis; however, these findings could not be confirmed using culture or molecular techniques (Holmberg et al., 1999; O'Halloran et al., 1998). Lastly, *B. elizabethae* has been reported as a potential canine pathogen on the basis of molecular detection in a dog with a history of lethargy, decreased appetite, weight loss, and several hematological and biochemical abnormalities (Mexas et al., 2002).

Transmission. Rats (*Rattus norvegicus*) represent the primary reservoir of *B. elizabethae* (Birtles et al., 1999; Ellis et al., 1999a). Little information is available pertaining to possible vectors involved in the transmission of *B. elizabethae*; a rodent

survey performed in Kabul, Afghanistan demonstrated infection of rodent fleas with *B. elizabethae* (Marie et al., 2006), and two *Bartonella* species closely related to *B. elizabethae* were described in four fleas that were removed from mice and a rat from Portugal (De Sousa et al., 2006).

Recent epidemiological data. *Bartonella elizabethae* seroprevalence in intravenous drug users in the United States and Sweden has been reported to range between 33 and 46% (Comer et al., 1996; Comer et al., 2001; McGill et al., 2003), and in homeless, clinic patients in downtown Los Angeles, the seroprevalence of *B. elizabethae* was 12.5% (25/200 patients) (Smith et al., 2002). Several factors may give rise to the increased *B. elizabethae* seroprevalence detected in homeless populations and intravenous drug users including: increased exposure to the rodent reservoir that is a common inhabitant of many metropolitan cities; engaging in unsafe behaviors such as sharing of needles or other drug injection equipment; living and/or foraging in rodent-infested areas; or being concurrently infected with other diseases often associated with homelessness or intravenous drug use (e.g., hepatitis B/C or HIV) (Smith et al., 2002).

As mentioned in the discussion of *B. henselae*, a recent dramatic increase in the incidence of sudden, unexpected, cardiac death observed in Swedish male orienteers caused researchers to evaluate whether *Bartonella* may act as a contributing factor (Larsson et al., 1999; Wesslen et al., 1996). Although PCR analyses of autopsy tissues detected *B. quintana* and *B. henselae*, IFA tests demonstrated overall seroreactivity to *B. elizabethae*, *B. henselae*, and *B. quintana* at 31%, 3%, and 1.4%, respectively, in 1,136

samples tested from elite orienteers (McGill et al., 2001). The overall seroprevalence in the orienteers (31%) was significantly ($p < 0.001$) higher than in 322 time-matched, healthy, Swedish blood donors, of whom 22 (6.8%) were seroreactive to *B. elizabethae*. The high seroreactivity to *B. elizabethae* in orienteers likely skewed the overall *Bartonella* seroprevalence, as the seroreactivity to *B. henselae* and *B. quintana* was only slightly higher in orienteers (3.0%, 1.4%, respectively) than in the healthy blood donors (1.6%, 0.3%, respectively).

In Denmark, a similar case-control study was performed to investigate the seroprevalence of *Bartonella* species in Danish elite orienteers (Schiellerup et al., 2004). With 265 individuals enrolled in the study (43 elite orienteers, 63 elite indoor sportsmen, and 159 blood donors), *Bartonella* antibodies were detected in sera from five persons. *Bartonella henselae* was detected in one elite orienteer, one handball player, and one blood donor, while *B. elizabethae* was detected in one handball player and one basketball player. The authors suggested that contrasting seroprevalences in the Danish and Swedish studies may reflect differences in the serological methods used for testing in the two studies.

***Bartonella vinsonii* subspecies *berkhoffii*.**

History. Originally isolated in the 1940s from Canadian voles (*Microtus pennsylvanicus*), *B. vinsonii* subspecies *vinsonii* has not yet been isolated or shown to be pathogenic in any other host (Baker 1946; Weiss et al., 1978; Weiss et al., 1982). No additional *B. vinsonii* isolates had been described until 1995 when Breitschwerdt et al.

(1995) reported a similar, fastidious, gram-negative organism in a dog with valvular endocarditis. Subsequent genotypic characterization of the vole and canine isolates resulted in a taxonomic division of the *B. vinsonii* species into subspecies; the vole and canine isolates were designated *B. vinsonii* subspecies *vinsonii* and *B. vinsonii* subspecies *berkhoffii*, respectively (Kordick et al., 1996). Recently, four different types of *B. vinsonii* (*berkhoffii*) (Types I to IV) have been described (Maggi et al., 2006).

Clinical presentation. Since its description, *B. vinsonii* (*berkhoffii*) has been associated with a wide variety of clinical manifestations in dogs including polyarthritis, cutaneous vasculitis, cardiac arrhythmias, myocarditis, granulomatous lymphadenitis, granulomatous rhinitis, and epistaxis (Breitschwerdt et al., 1999; Breitschwerdt et al., 2004; Breitschwerdt et al., 2005; Pappalardo et al., 2000b). Further, *B. vinsonii* (*berkhoffii*) has been isolated from clinically healthy dogs with no associated disease manifestations (Kordick et al., 1996; Kordick et al., 1998). *Bartonella vinsonii* (*berkhoffii*) was detected by PCR in a single case of human endocarditis and was therefore added to a growing list of zoonotic *Bartonella* species (Roux et al., 2000).

Eleven of 12 dogs presenting with cardiac arrhythmias, endocarditis, or myocarditis were seroreactive to *B. vinsonii* (*berkhoffii*) antigens, and *B. vinsonii* (*berkhoffii*) was detected by PCR in the blood or heart valve of three of these dogs (Breitschwerdt et al., 1999). PCR analysis of the blood or tissues of an additional seven dogs demonstrated evidence of a closely related, general alpha-proteobacterial infection, suggesting that one or more alpha-Proteobacteria may be inducing disease in these dogs. Recent data have

indicated that although blood-culture negative, three of five dogs with *Bartonella*-associated endocarditis were *B. vinsonii (berkhoffii)* positive when PCR was performed using the affected heart valve (MacDonald et al., 2004).

In experimental models, inoculation of specific pathogen free dogs with culture-grown *B. vinsonii (berkhoffii)* resulted in chronic infection and alterations, both quantitative and functional, in CD4+, CD8+, and B lymphocytes (Pappalardo et al., 2000a; Pappalardo et al., 2001). Numerous defects were observed in *B. vinsonii (berkhoffii)* experimentally infected dogs including: cyclic CD8+ lymphopenia, sustained suppression of CD8+ lymphocytes accompanied by an altered cell surface phenotype, an increase in CD4+ lymphocytes in the peripheral lymph nodes, defects in monocytic phagocytosis, and impaired antigen presentation. Changes such as these may potentially predispose *B. vinsonii (berkhoffii)*-infected dogs to develop autoimmune or immune-mediated disease manifestations.

Bartonella vinsonii (berkhoffii) has been associated with granulomatous disease, uveitis, epistaxis, and endocarditis. Utilizing serological, histopathological, and molecular techniques, *B. vinsonii (berkhoffii)* was associated with granulomatous lymphadenitis and granulomatous rhinitis in two dogs (Pappalardo et al., 2000b); additionally, both *B. henselae* and *B. vinsonii (berkhoffii)* were detected by PCR in a dog with systemic granulomatous disease and sialometaplasia (Saunders et al., 2006). *Bartonella vinsonii (berkhoffii)*, as indicated by serological testing, was believed to induce anterior uveitis and choroiditis in a dog (Michau et al., 2003). Further, *B. vinsonii (berkhoffii)* seroreactivity has been demonstrated in several dogs with epistaxis (Breitschwerdt et al., 1995;

Breitschwerdt et al., 1999; Breitschwerdt et al., 2005; Smarick et al., 2004), and recently, *B. vinsonii (berkhoffii)* Type II was successfully isolated from a dog with epistaxis (Breitschwerdt et al., 2005). Lastly, in a retrospective case series, the review of medical records for 24 *B. vinsonii (berkhoffii)*-seroreactive dogs revealed various clinical manifestations and clinicopathological abnormalities that may be attributed to *B. vinsonii (berkhoffii)* infection including: fever/joint/muscle pain, cutaneous vasculitis, seizures, ataxia, uveitis and ocular hemorrhage, immune-mediated hemolytic anemia, neutrophilic or granulomatous meningoencephalitis, and neutrophilic polyarthritis (Breitschwerdt et al., 2004).

Transmission. Despite reports of low seroprevalence (Henn et al., 2005; Pappalardo et al., 1997; Solano-Gallego et al., 2004), domestic dogs are believed to be the primary reservoir of *B. vinsonii (berkhoffii)*. In several Californian studies, coyotes (*Canis latrans*) appear to serve as important wildlife reservoirs for *B. vinsonii (berkhoffii)*, as demonstrated by seroprevalence rates ranging from 28 to 76% and PCR evidence of infection in 28% of animals sampled (Beldomenico et al., 2005; Chang et al., 1999; Chang et al., 2000; Hoar et al., 2003). It should be noted that these samples were collected in highly endemic tick areas, perhaps explaining the large number of seroreactive and bacteremic coyotes observed in these studies. Evidence of *B. vinsonii (berkhoffii)* infection in gray foxes (*Urocyon cinereoargenteus*) captured in California has also been recently described and may represent an additional wildlife reservoir for the organism (Maggi et al., 2006). Based on ITS and Pap31 typing, gray foxes are typically infected with a different

strain of *B. vinsonii* (*berkhoffii*) Type III, as compared to dogs and coyotes. Recently, type III has been isolated from the blood and heart valve of a military working dog that died of endocarditis (EB Breitschwerdt, unpublished data).

Although not definitely established, several reports, including serological, molecular, and descriptive data, support the potential for tick transmission of *B. vinsonii* (*berkhoffii*) both in the United States and worldwide (Baneth et al., 1998; Breitschwerdt et al., 1998; Chang et al., 2001; Honadel et al., 2001; Kordick et al., 1999; Muller et al., 2004; Mylonakis et al., 2004; Pappalardo et al., 1997; Pappalardo et al., 2000b; Tuttle et al., 2003). To further support a tick vector in the transmission of *B. vinsonii* (*berkhoffii*), serosurveys indicate that seroprevalence, although low in many dog populations, may vary with tick exposure. In a serosurvey of sick dogs from North Carolina and Virginia that were admitted to the veterinary teaching hospital, *B. vinsonii* (*berkhoffii*) seroprevalence was 3.6% (69/1,920 samples) (Pappalardo et al., 1997). The seroprevalence of *B. vinsonii* (*berkhoffii*) in Israeli dogs with prior tick exposure was reported as 10% (4/40 samples) (Baneth et al., 1998), while 8.7% (162/1,872 samples) of clinically healthy, military working dogs, with known tick exposure, were *B. vinsonii* (*berkhoffii*) seroreactive (Honadel et al., 2001). Conversely, in a flea- and tick-infested kennel of sick Walker hounds, nearly all (25/27 samples, 93%) of the dogs were seroreactive *B. vinsonii* (*berkhoffii*) and many were concurrently co-infected with other tick-borne organisms such as *Ehrlichia canis*, *Ehrlichia chaffeensis*, *Ehrlichia ewingii*, *Ehrlichia equi* (now *Anaplasma phagocytophilum*), *Rickettsia* species, and *Babesia canis*; these results were also confirmed through PCR analyses (Kordick et al., 1999).

Recent epidemiological data. Similar to *B. henselae*, much of the literature for *B. vinsonii (berkhoffii)* is focused on serosurveys in dogs or coyotes and the risk factors associated with seroreactivity.

Despite a low seroprevalence (3.6%, 69/1,920 dogs) to *B. vinsonii (berkhoffii)* in sick dogs from North Carolina and Virginia, *B. vinsonii (berkhoffii)* seroreactive dogs were more likely to be outdoor dogs (OR = 8.5, 95% CI, 3.39 to 21.71), living in rural environments (7.1, 2.13 to 25.00), and were allowed to roam freely (4.8, 2.39 to 9.79) (Pappalardo et al., 1997). Perhaps the most important finding of this case-control study was that *B. vinsonii (berkhoffii)* seroreactive dogs were 14.2 times (95% CI, 4.63 to 45.38) more likely to have a history of heavy tick exposure. To further assess the correlation with tick exposure and *B. vinsonii (berkhoffii)* seroreactivity, serum samples collected from dogs with known tick exposure, such as those seroreactive to *E. canis* and *B. canis*, were tested for reactivity to *B. vinsonii (berkhoffii)* antigens using an IFA test. In these analyses, 54/151 (36%) *E. canis* seroreactors and 4/7 (57%) *B. canis* seroreactors were also concurrently seroreactive to *B. vinsonii (berkhoffii)*, suggesting that *Rhipicephalus sanguineus*, the tick vector for *E. canis* and *B. canis*, may be involved in *B. vinsonii (berkhoffii)* transmission in dogs. Since this initial report, other data have been published in support of tick transmission for *B. vinsonii (berkhoffii)* as assessed by concurrent seroreactivity to several other known tick-transmitted pathogens, such as *E. canis*, *B. canis*, or *Borrelia burgdorferi* (Breitschwerdt et al., 1998; Hinrichsen et al., 2001; Honadel et al., 2001; Kordick et al., 1999).

A serosurvey of sick and healthy dogs in the southeastern United States reported a *B. vinsonii (berkhoffii)* seroprevalence of 4.7% (14/295 dogs) in sick dogs versus 1% (1/99 dogs) in healthy dogs (Solano-Gallego et al., 2004). Other *B. vinsonii (berkhoffii)* serosurveys have been performed outside of the United States, for example: four of 40 (10%) Israeli dogs with previous tick exposure were *B. vinsonii (berkhoffii)* seroreactive (Baneth et al., 1998); nearly 40% of sick dogs from Thailand (19/49, 38%) were seroreactive to *B. vinsonii (berkhoffii)* antigens, but no dog was PCR positive (Suksawat et al., 2001); overall, 56 of 147 (38%) dogs tested in Morocco were *B. vinsonii (berkhoffii)* seroreactive, and a much of the overall seroprevalence was attributed to stray dogs (38 to 47% depending on the region surveyed) as opposed to a much lower seroprevalence in pet dogs (1/24 dogs, 4%) (Henn et al., 2006); lastly, *B. vinsonii (berkhoffii)* seroreactivity was reported as 1.1% in 466 dogs surveyed in three different regions in northeastern Spain (Solano-Gallego et al., 2006).

As previously described, *B. vinsonii (berkhoffii)* was detected by PCR in three of five dogs with endocarditis during a prospective study in California (MacDonald et al., 2004). All dogs with *Bartonella* endocarditis had vegetative lesions on the aortic valve only. This finding may have contributed to the reduced overall survival time ($p = 0.002$) of this group when compared to dogs with endocarditis due to non-*Bartonella* bacteria, which most frequently involves the mitral valve. This study also reported that a high serological titer ($> 1:512$) to *Bartonella* antigens was a valuable ante-mortem diagnostic tool for *Bartonella*-associated endocarditis in dogs.

In an elaborate study to evaluate *Bartonella* seroprevalence in a population of sick dogs from northern California and to identify potential risk factors and clinical signs associated with seroreactivity, 102 of the total 3,417 (2.9%) dogs were seroreactive to *B. henselae*, *B. clarridgeiae*, and/or *B. vinsonii (berkhoffii)* via an enzyme linked immunosorbent assay (ELISA) technique (Henn et al., 2005). When considering only the 102 seroreactors, 36 (35.3%), 34 (33.3%), 2 (2.0%) reacted to *B. henselae* only, *B. clarridgeiae* only, and *B. vinsonii (berkhoffii)* only, respectively. A case-control study was conducted as part of the serosurvey and utilized 305 dogs (102 dogs seroreactive to *B. henselae*, *B. vinsonii (berkhoffii)* and/or *B. clarridgeiae* and 203 seronegative dogs). As mentioned in the *B. henselae* discussion, seroreactivity to *Bartonella* test antigens was significantly associated with breed, sex, lameness, arthritis-related lameness, splenomegaly, and nasal discharge/epistaxis.

Bartonella bovis

History. *Bartonella weissii* was provisionally described by Regnery and colleagues at the Centers for Disease Control (R. Regnery, N. Marano, P. Jameson, E. Marston, D. Jones, S. Handley, C. Goldsmith, and C. Greene, 15th Meeting of the American Society of Rickettsiology, abstract 4, 2000). Using partial citrate synthase gene sequence analysis on 33 cat blood isolates, at least two distinct *Bartonella* species were present. Although the majority of these isolates were identical to *B. henselae*, isolates from two domestic cats from Utah and Illinois demonstrated a novel citrate synthase

genotype. Further characterization using 16S rDNA and *groEL* gene sequences revealed differences in the DNA profiles when compared to the other study isolates, and electron microscopy of this novel feline isolate demonstrated a flagellated bacteria. The novel genotype was designated *B. weissii*, and although sequence data exist (GenBank Accession Nos. AF071190 and AF199502), the type strain is not available. Based on subsequent findings in cattle, the organism originally described as *Bartonella weissii* was renamed *B. bovis* (Bermond et al., 2002).

Clinical presentation. To date, little to no information is provided in the published literature pertaining to the clinical manifestations of *B. bovis* infection, and no clinical information has been reported for the animals from which *B. bovis* isolation was successful. In a study of North Carolina beef cattle infected with *B. bovis*, fescue toxicity, characterized by severe lameness and loss of the tail switch, was observed in approximately one-third of the entire herd; however, it is uncertain if this finding was related to *B. bovis* infection in a genetically susceptible breed with concurrent exposure to toxin-containing fescue (Breitschwerdt et al., 2001). In a second report, although nearly 93% of heifers surveyed were *B. bovis* bacteremic, a study of 448 French dairy cattle failed to correlate chronic *B. bovis* infection with ongoing reproductive problems within the herd (Maillard et al., 2006). Recently *B. bovis* DNA was detected in two cases of bovine endocarditis (Maillard et al., Submitted for publication at Emerging Infectious Diseases), along with a report of *B. bovis* involvement in a case of human bacillary angiomatosis (García-Esteban et al., 2005).

Transmission. Little to no information is published in the literature pertaining to possible means of transmission for *B. bovis*. Biting flies and/or ticks have been suggested as possible vectors for *B. bovis* (Chomel et al., 2004). Tick infestation is a common finding in cattle, thereby providing a possible source of infection; in contrast, fleas are rarely observed on cattle (Chang et al., 2000). *Bartonella bovis* was recently amplified from ticks (*Ixodes* and *Rhipicephalus* species) collected in the pastures grazed by French dairy cattle (Maillard et al., 2006). *Bartonella bovis* was detected by PCR in a pooled sample of horn flies (*Haematobia* species) removed from cattle in northern California (Chung et al., 2004). Further, recent studies of *Hippoboscidae* species have shown a very high prevalence of *Bartonella* DNA in these biting flies, suggesting that bloodsucking insects may be an important vector of *Bartonella* in ruminants (Dehio et al., 2004; Halos et al., 2004).

Recent epidemiological data. *Bartonella bovis* has been detected in free-ranging wild and domestic ruminants in the United States. In a study designed to determine the prevalence of *Bartonella* infection, close similarity was found between all isolates from dairy and beef cattle, mule deer, and elk, and also between these isolates and *B. bovis* (Chang et al., 2000).

A study in North Carolina beef cattle reported seroreactivity to *B. bovis* antigens in 36 of 38 animals and microbiological isolation of *B. bovis*, confirmed by DNA sequencing, from three of six randomly selected whole blood samples (Breitschwerdt et al., 2001).

In 2002, it was reported that a novel *Bartonella* species was isolated from a cow in Europe; this isolate demonstrated 100% sequence similarity to the original cat *B. weissii* (now *bovis*) isolate when analyzed by 16S rRNA and *gltA* gene sequences. The cow isolate, named *B. bovis* Bermond *et al.* sp. nov (Bermond et al., 2002), has been detected in 53% of French dairy cattle (H.-J. Boulouis, R. Heller, F. Barrat, B. Van Laere, D. Thibault, F. Claro, S. Chastant, E. Plouzeau, A. Lecu, F. Ollivet, J. Rigoulet, X. Legendre, P. Moisson, M. Leclerc-Cassan, B. B. Chomel, and Y. Piemont, 2nd International Conference of Emerging Zoonoses, abstract 61, 1998) and is closely related to the *Bartonella* species detected in 49% of cattle from California and Oklahoma (Chang et al., 2000). Considering that this *Bartonella* species is widely distributed among cattle in France, among cattle and wild ruminants in the United States, and has been recently isolated from cattle in Africa (Bermond et al., 2002; Breitschwerdt et al., 2001; Chang et al., 2000; Maillard et al., 2004; Maillard et al., 2006; Raoult et al., 2005), *Bartonella weissii* was appropriately renamed *B. bovis*.

Chronic *B. bovis* infection was recently demonstrated in a herd of 448 French dairy cows and heifers; in this survey, nearly 60% (236/400 samples) of the cattle were culture positive for *B. bovis*, with the highest prevalence in heifers (62/67, 92.5%) (Maillard et al., 2006).

Recently, molecular and serological evidence of *B. bovis* infection, likely resulting in endocarditis in cattle, has been reported (Maillard et al., Submitted for publication at Emerging Infectious Diseases). Two of 22 (9.1%) cases of bovine endocarditis were PCR positive for *B. bovis*; moreover, these cases were seroreactive to *B. bovis* antigens, with high reciprocal titers of 640 and 5,120, further suggesting that *B. bovis* is the causative agent of these two endocarditis cases. As many of the *Bartonella* species that induce endocarditis are zoonotic, such as *B. quintana* and *B. henselae*, these current findings suggest a possible role for *B. bovis* as a potential agent of human endocarditis or infection.

To date, no additional isolates of *B. bovis* in cats have been reported in the literature, and it has been suggested that the original *B. bovis* isolates may have resulted from a transfer from a bovine to a feline population. Due to the possibility of human infection during the slaughter and evisceration of deer, elk, and cattle, *B. bovis* could be a potential zoonotic pathogen (Bermond et al., 2002).

Summary

Since the initial association of *Bartonella* species with diseases in immunocompromised patients, members of this genus have emerged as highly adapted bacteria and as important, emerging pathogens in human and veterinary medicine. From the data presented, many animals including bovine, canine, feline, human, and rodent species, may serve as chronically infected reservoir hosts for various *Bartonella* species. Considering the growing list of *Bartonella* species that have been isolated and characterized within the last

15 years, the wide range of reservoir hosts, the diverse list of clinical manifestations of infection, and the striking disease similarities in dogs and humans, *Bartonella* bacteria have proven to be of comparative medical importance.

Comparative epidemiological considerations: The dog as a model

Introduction

Humans typically represent incidental hosts for *Bartonella* species, as the organisms are generally found in their respective reservoir hosts, including companion animals, such as cats and dogs that live in daily contact with people. Pet-associated diseases are currently being recognized with greater frequency, a finding that may be attributed to several factors: American households have more dogs (estimated at 70 million) and cats (estimated at 100 million) than ever before, 75% of the recently discovered emerging infectious diseases are zoonotic in nature (Cleaveland et al., 2001; Taylor et al., 2001), and intimate contact between pets and their owners is much greater than in previous generations. Recent reports indicate that zoonotic diseases were twice as likely to be associated with emerging or newly discovered infections when compared to non-zoonotic pathogens (Taylor et al., 2001). These findings highlight the pressing need for a collaborative relationship between human medicine, veterinary medicine, and the public health and animal health infrastructures. A fundamental element of this cooperative

association is comparative medicine, the study of the anatomic, physiologic, and pathogenesis of human and animal disease through the use of animal models or comparative investigation of naturally occurring animal and human diseases (Kahn 2006). Animal populations with naturally occurring disease provide a comparative medical resource that is largely unused to date. Importantly, the clinical manifestations of naturally occurring animal infectious diseases often display striking similarities to the disease pathogenesis in human beings.

The domestic dog, *Canis familiaris*, has more naturally occurring, inherited disorders than any other species, with the exception of human beings (Ostrander et al., 2000; Patterson 2000). Additionally, dogs share a common environment with humans, thereby facilitating the investigation of complex, multi-factorial interactions and risk factors of many human diseases. These findings, coupled with the similarities in physiology, clinical disease presentation, and therapeutic response to treatment as demonstrated between dogs and humans, make the dog an excellent candidate for a model of human disease. Further, the domestic dog represents a more natural population when compared to inbred laboratory rodents typically utilized to investigate human disease. With more similarities to humans, in anatomy, physiology, and enzyme systems and kinetics, dogs naturally develop diseases that share many characteristics with human disease. Further, when narrowing the focus to vector-borne pathogens, dogs experience substantially greater exposure to vector-borne organisms and thus can serve as important natural reservoirs for human infection or as important environmental sentinels for human disease (Chomel et al., 2006; Duncan et al., 2004; Eng et al., 1988; Guerra et al., 2001).

With the recent publication of the canine genome sequence (Lindblad-Toh et al., 2005), comparative genomic analyses have demonstrated substantial sequence similarity between the canine and human genomes (Kirkness et al., 2003). Currently, dogs are being used as comparative models for inherited and sporadic human oncogenesis and in preclinical drug studies to evaluate the efficacy and toxicity of new therapeutic agents (Khanna et al., 2006; Knapp et al., 1997; Mack 2005; Starkey et al., 2005). Although certainly a benefit to veterinary medicine, the use of dogs as a comparative model for various human diseases has the potential to provide a substantial advantage to human medicine as well.

Common diseases related to *Bartonella* infection in dogs and humans

The spectrum of disease manifestations attributable to *Bartonella*-associated infections is particularly broad, ranging from vasoproliferative lesions to granulomatous inflammation, and the type and extent of disease varies significantly with the immune status of the host. Importantly, all *Bartonella* species known to cause disease in dogs have also been shown to be pathogenic in humans; further, of comparative medical interest, similar clinical symptoms of *Bartonella* species infections occur in humans and dogs. It has been recently suggested that dogs may serve as sentinels for *Bartonella* infection in the human population and represent an important comparative model (Chomel et al., 2006). As detailed in the following paragraphs, *Bartonella* infections have been associated with several clinical conditions observed in both dogs and humans, including peliosis hepatis,

endocarditis, myocarditis, granulomatous lymphadenitis, granulomatous hepatitis, and encephalitis.

Endocarditis. In recent years, endocarditis may represent the most prevalent disease process associated with *Bartonella* infection in immunocompetent humans, as demonstrated by the expanding list of *Bartonella* species linked to endocarditis, including *B. alsatica* (Raoult et al., 2006), *B. elizabethae* (Daly et al., 1993), *B. henselae* (Fournier et al., 2001; Hadfield et al., 1993; Holmes et al., 1995), *B. koehlerae* (Avidor et al., 2004), *B. quintana* (Fournier et al., 2001; Spach et al., 1993), *B. vinsonii* subspecies *arupensis* (Fenollar et al., 2005; Welch et al., 1999), and *B. vinsonii* subspecies *berkhoffii* (Roux et al., 2000).

Three *Bartonella* species, *B. quintana*, *B. elizabethae*, and *B. henselae*, were each attributed to independent cases of human endocarditis in 1993 (Spach et al., 1993; Daly et al., 1993; Hadfield et al., 1993). Although the 1993 report of *B. elizabethae* endocarditis represents the only known case, other *Bartonella* species, particularly *B. quintana* and *B. henselae*, have been detected in numerous endocarditis patients. In fact, these two species may account for up to 30% of human endocarditis cases as demonstrated by a recent case series of 348 blood culture-negative endocarditis patients (Houpikian et al., 2005). In this study, 99 (99/348, 28%) cases had serological, microbiological, and/or molecular evidence of infection with a *Bartonella* species. Of 49/99 cases positive by culture and/or PCR on the affected heart valve, 38 were infected with *B. quintana*, 10 with *B. henselae*, and one with *B. vinsonii* (*berkhoffii*) (Houpikian et al., 2005). In light of the difficulties associated

with the microbiological isolation of *Bartonella* species, serological analyses have been utilized successfully in the diagnosis of *Bartonella* endocarditis, and high titers have been positively predictive of *Bartonella* endocarditis in humans (Fournier et al., 2002a; Raoult et al., 1996; Wesslen et al., 2001).

In general, *Bartonella* endocarditis is likely attributed to chronic, persistent bacteremia (Fournier et al., 2001). In the majority of *Bartonella* endocarditis cases, the vegetative lesions are preferentially located on the aortic valve (Raoult et al., 1996), and high IFA antibody titers (reciprocal titers of ≥ 800) are observed in most patients (Fournier et al., 2002a). *Bartonella* endocarditis is persistently blood-culture negative, which often results in delayed diagnoses and a higher mortality rate when compared to other forms of bacterial endocarditis. Although often negative in bacteriologic culture, many samples are positive when evaluated by PCR for *Bartonella* DNA (Fournier et al., 2001). *Bartonella henselae*-associated endocarditis is observed most frequently in persons with pre-existing valvular lesions, while *B. quintana* endocarditis is often not associated with previous valvulopathy (Fournier et al., 2001).

Soon after the 1993 reports of *Bartonella* species involvement in human endocarditis, the first case of canine endocarditis, associated with *B. vinsonii* (*berkhoffii*), was reported (Breitschwerdt et al., 1995). Subsequently, other *Bartonella* species, including *B. clarridgeiae*, *B. quintana*, and *B. washoensis*, have all been successfully isolated from dogs with endocarditis (Chomel et al., 2001; Chomel et al., 2003; Kelly et al., 2006). In a recent, prospective study of dogs in northern California, *Bartonella* species were the most common cause of endocarditis and were involved in nearly one-third (5/18

cases, 27.7%) of canine endocarditis cases during a two-year period (MacDonald et al., 2004). Although, four of these five cases were blood-culture negative despite the use of *Bartonella*-specific culture methods, *B. vinsonii* (*berkhoffii*) was detected by PCR analyses of the affected heart valve in three of five dogs (MacDonald et al., 2004). In a more recent evaluation of data from the same veterinary teaching hospital, it has been suggested that the previously reported incidence of 28% may be a substantial underestimation of the true incidence of *Bartonella*-associated endocarditis in dogs. As shown in a retrospective case series, seven of 28 (25%) dogs diagnosed with endocarditis of unknown cause from 2001 to 2005 were not tested for *Bartonella* (Sykes et al., 2006).

Of comparative medical interest, many of the clinical signs present at diagnosis of *Bartonella*-associated endocarditis are similar between dogs and humans. Dogs with *Bartonella* endocarditis have massive vegetative lesions on the aortic valve only, and a high serological titer (> 1:512) to *Bartonella* antigens has been shown provide a valuable ante-mortem diagnosis (Breitschwerdt et al., 1999; MacDonald et al., 2004; Pesavento et al., 2005). Also similar to humans, fever of unknown origin can precede the diagnosis of endocarditis in dogs for many months (Breitschwerdt et al., 2000; Foucault et al., 2002; MacDonald et al., 2004), although more recent research has indicated that dogs with *Bartonella*-related endocarditis are often afebrile upon presentation when compared to dogs with endocarditis attributed to bacteria other than *Bartonella* (Sykes et al., 2006).

Peliosis hepatis. In HIV-infected patients, an angiogenic, vasoproliferative, tumor-like lesion, known as peliosis hepatis, has been attributed to *B. henselae* infection.

The association between the clinical condition and *B. henselae* was demonstrated by the presence of the organism in infected tissue, by histopathological analyses, and by partial 16S rRNA gene sequence data from the organism *in situ* and from culture (Perkocha et al., 1990; Relman et al., 1990; Slater et al., 1990; Slater et al., 1992; Welch et al., 1992). Much of this early research was reported in case reports or case series, often with fewer than 10 to 15 cases presented. Larger case series, some with as many as 50 patients, along with several case-control studies have been reported in subsequent years, primarily in immunocompromised, HIV-infected populations (Koehler et al., 1993; Koehler et al., 1997; Koehler 1995; Mohle-Boetani et al., 1996; Tappero et al., 1993b). In a molecular epidemiology study, peliosis hepatis was associated exclusively with *B. henselae* infections in 49 HIV-infected patients (Koehler et al., 1997).

Soon thereafter, *B. henselae* DNA was amplified and sequenced on two independent occasions from several cystic hepatic lesions in a dog diagnosed with peliosis hepatis (Kitchell et al., 2000), a disorder previously demonstrated to be attributed to *B. henselae* infection in human patients (Koehler et al., 1997). This dog presented with hepatomegaly and elevated alkaline phosphatase activity, both of which have been shown in case-control studies to be significantly ($p \leq 0.05$) associated with peliosis hepatis in humans (Mohle-Boetani et al., 1996).

Myocarditis. *Bartonella* infections have also been associated with myocardial inflammation in dogs and humans. Myocarditis, along with endocarditis, was attributed to infection with *B. henselae* as detected by serological, histopathological, and molecular

analyses in an immunocompetent patient (Holmes et al., 1995). Further, *Bartonella quintana* infection was detected in the myocardial tissues of a 60-year-old Swedish male who died suddenly during a running competition (Holmberg et al., 1999). In addition, the Swedish sport of orienteering was marked by a dramatic increase in sudden, unexpected, cardiac-related deaths (n = 16) in young, clinically healthy, elite competitors over a 13-year period (Larsson et al., 1999; Wesslen et al., 1996). At autopsy, morphological changes were consistent with myocarditis in the majority of these cases (Wesslen et al., 1996), and *B. henselae* and *B. quintana* were detected in heart (4/5 tissues tested) and lung (1/5 tissues tested) tissue by PCR amplification (McGill et al., 2001; Wesslen et al., 2001). Researchers suggested that *Bartonella* infection induced silent, subacute myocarditis, resulting in electric instability and the untimely death of these elite Swedish orienteers. Another case of *Bartonella* infection and chronic active myocarditis was documented as an atypical manifestation of cat scratch disease attributed to *B. henselae* (Meininger et al., 2001). Lastly, a single case of myocarditis attributed to *B. washoensis*, an infection hypothetically contracted from ground squirrels, has been reported (Kosoy et al., 2003).

Dogs presenting with multifocal areas of severe myocardial inflammation have demonstrated seroreactivity to *Bartonella* antigens, and several *Bartonella* species have been detected by PCR in the blood or heart valves (Breitschwerdt et al., 1999; MacDonald et al., 2004). A prospective study determining the prevalence of *Bartonella* infection in dogs with arrhythmias or biopsy-confirmed myocarditis has not been performed.

Select granulomatous diseases. In traditional cat scratch disease, granulomatous, suppurative lesions are often attributable to *B. henselae* (Bass et al., 1997b). In an immunocompetent host, cat scratch disease typically involves a prolonged regional lymphadenopathy, often in proximity to the inoculation papule (cat scratch or bite); however, more serious complications are well documented and may occur in 5 to 15% of infected humans (Chomel et al., 2004). For example, *B. henselae* infection has been attributed to several granulomatous syndromes in humans, including granulomatous lymphadenitis, granulomatous hepatosplenitis, granulomatous osteitis, and orbital granulomas (Daybell et al., 2004; Dondey et al., 1997; Hansmann et al., 2005; Liston et al., 1996). In a few case reports, *B. henselae* infection in humans has been associated with neurological manifestations including fatal granulomatous meningitis and encephalitis (Gerber et al., 2002; Marra 1995). Atypical manifestations of cat scratch disease, characterized by granulomatous reaction in the breast tissue and the lymph nodes, were attributed to *B. henselae* infection in four women (Godet et al., 2004; Markaki et al., 2003). Systemic symptoms of atypical cat scratch disease, characterized by fever of unknown origin and multiple lesions of the liver and spleen, diagnosed as granulomatous hepatitis, were described in a case report of two children; infection with *B. henselae* was demonstrated by high antibody titers or detection of *B. henselae* DNA in the liver biopsy (Dangman et al., 1995). In a case review of 41 patients with presumed hepatic or splenic disease attributed to *Bartonella* infection, granulomatous infection of the liver and/or spleen was reported in 21 cases (51%) (Liston et al., 1996). *Bartonella henselae* was associated with a case of granulomatous hepatitis in an HIV-infected individual with an

elevated antibody titer to *B. henselae* (Estrella et al., 2002). In a few liver transplant patients, rare pathological lesions, such as disseminated granulomatous hepatitis, have been attributed to *B. henselae* infection through serological or molecular methods (Bonatti et al., 2006; Humar et al., 1999). By microbiological isolation or molecular detection, *B. quintana* has been reported as a cause of granulomatous mediastinal lymphadenopathy in two case reports, and *B. quintana*-associated granulomas have been observed in thalamic lesions of a patient with central nervous system disease (Drancourt et al., 1996; Parrott et al., 1997; Raoult et al., 1994).

In dogs, a seroreactive IFA titer was used to link *B. vinsonii* (*berkhoffii*) with a case of severe granulomatous lymphadenitis (Pappalardo et al., 2000b). Warthin Starry-staining bacteria were observed within the lymph node, and *Bartonella* DNA was detected by PCR and Southern blot hybridization, although the specific *Bartonella* species was not determined using molecular techniques (Pappalardo et al., 2000b). Interestingly, the source of *Bartonella* infection was believed to be an engorged tick that was removed from the left ear seven days prior to the onset of illness. Although the sources of infection differed, the historical course and clinicopathologic findings for this dog were comparable to those of cat scratch disease lymphadenitis observed in human patients (Pappalardo et al., 2000b). *Bartonella vinsonii* (*berkhoffii*) was also implicated in a case of granulomatous rhinitis, as demonstrated by serological analyses and PCR amplification with restriction fragment length polymorphism in a nasal biopsy tissue (Pappalardo et al., 2000b). *Bartonella henselae* DNA has been detected in hepatic tissues collected from a dog with granulomatous hepatitis, while *B. clarridgeiae* DNA was detected in the liver of a dog with

lymphocytic hepatitis (Gillespie et al., 2003). In retrospective seroprevalence studies to identify clinicopathological abnormalities, both *B. henselae* and *B. vinsonii (berkhoffii)* seroreactivity was associated with a few cases of granulomatous meningoencephalitis in dogs (Breitschwerdt et al., 2004; Goodman et al., 2005). More recently, both *B. henselae* and *B. vinsonii (berkhoffii)* were detected by PCR in a dog with systemic granulomatous disease and sialometaplasia (Saunders et al., 2006). Further, *B. henselae* has been suggested as the cause or a co-factor for the development of pyogranulomatous lymphadenitis in dogs, as demonstrated by Western immunoblot and IFA serological analyses and molecular evidence of *B. henselae* within the affected lymph nodes and peripheral blood (Morales et al., 2007).

Data evaluation and summary

When reviewing disease manifestations associated with *Bartonella* infection in dogs and humans, remarkable parallels are observed both within the similar spectrum of pathological lesions that have been reported, and in several instances, the clinical signs that occur prior to diagnosis of a *Bartonella*-associated disease. In the context of comparative medicine, examining the pathological consequences of *Bartonella* infection in dogs may provide important insights for human medicine and vice versa.

As is obvious from the preceding paragraphs, the majority of the studies relative to *Bartonella* infection in canine and human medicine can be categorized as descriptive epidemiological studies. Case reports, case series, and surveys provide interesting

information on unique, novel, and perhaps rare, clinical conditions, and their value lies in formulating questions and developing hypotheses that can be tested experimentally or in a prospective, population-based study, thereby allowing more rigorous interpretation of the results. However, few population-based studies have been conducted with respect to *Bartonella* infection.

When considering blood culture-negative endocarditis as potentially attributed to *Bartonella* infections in human patients, larger case series have been recently published, with one report describing 348 patients collected over a period of nearly 20 years (Houpikian et al., 2005). Aside from human endocarditis data, unfortunately, no larger integrative studies have combined the information, derived from other case reports or case series, within a particular framework to provide a summary of findings or recommendations.

In human and veterinary literature, other factors complicate the association between *Bartonella* species and disease, including: (1) studies that attribute disease manifestations to *Bartonella* infection based on serological data only, thereby linking causality with a measurement of exposure and immune response only; (2) the frequent lack of control patients or control samples (e.g., serum, blood, tissues) in case reports and case series; and (3) the uncertainty surrounding the prevalence of asymptomatic *Bartonella* infections in clinically healthy populations.

Because *Bartonella* species are recently discovered, because serological, microbiological, and molecular diagnostic testing have not provided sensitive or consistent results, and because this genus induces insidious and often non-specific disease

manifestations, large-scale funding to support well-designed, prospective, epidemiological studies has been limited or not available.

Theoretically, improved microbiological methods to enhance the detection and isolation of clinically important *Bartonella* species from humans and dogs would assist in the correlation of *Bartonella* species and disease causation. Additionally, the ability to successfully isolate *Bartonella* species will facilitate comparative microbiological studies. To this end, research was initiated to characterize a culture medium to support the growth and maintenance of several *Bartonella* species.

Detection of *Bartonella* species in clinical samples

Because *Bartonella* species frequently induce persistent intravascular infections, it has been difficult to directly attribute disease causation to *Bartonella* infection, a dilemma which is further compounded by the few, and some times very subtle, clinical abnormalities that can occur during the course of infection. The observation of chronic *Bartonella* bacteremia without overt signs of disease contradicts Koch's postulate that the blood of healthy humans and animals is free of bacteria (Jacomo et al., 2002). Nevertheless, an increasingly diverse spectrum of *Bartonella*-associated diseases have been recognized due to the development of improved serologic and molecular diagnostic tests, and many of these novel isolation or molecular detection techniques have shown to be more sensitive than conventional culture methods (Chenoweth et al., 2004; Cunningham

et al., 2000; Johnson et al., 2003; Koehler et al., 1992; La Scola et al., 1999; Pitulle et al., 2002; Raoult et al., 2003; Schwartzman et al., 1993; Wong et al., 1995).

Conventional microbiological methods

Traditionally, *Bartonella* organisms are cultivated at 37°C in an atmosphere containing 5% carbon dioxide; in contrast, *B. bacilliformis* has an optimal growth temperature ranging from 25 to 28°C and without supplemental carbon dioxide (Anderson et al., 1997). Due to their hemin-dependency, *Bartonella* species must be grown on agar enriched with 5 to 10% blood. Rabbit blood or horse blood is more effective than sheep blood for isolation (Maurin et al., 1997). It has been reported that optimal growth of *B. quintana* requires chocolate agar plates (Koehler et al., 1997); however, a larger scale study did not corroborate this observation, rather finding no evident superiority with a specific blood agar, but that the best growth was obtained when the blood agar was freshly prepared (La Scola et al., 1999). Visible colony formation may occur within 5 to 15 days or up to 45 days during primary culture; due to this slow growth, identification by standard biochemical methods may not be applicable (Boulouis et al., 2005). *Bartonella* may also be cultivated in broth with fetal bovine serum and in tissue culture (La Scola et al., 1999). As *Bartonella* are intraerythrocytic bacteria (Dehio 2004), many isolation methods utilize lysis-centrifugation tubes or freeze-thaw techniques to increase the efficiency of isolation from blood (Brenner et al., 1997; Regnery et al., 1992a; Welch et al., 1992).

For *Bartonella*, the primary difficulty associated with traditional microbiological methods is the extended period of time (average = 21 days) for primary isolation on blood agar plates, the standard method for diagnosis of *Bartonella* infection. However, isolation of *Bartonella* species on a blood agar plate is rarely successful, unless the patient or animal is infected with a retrovirus, such as HIV, is receiving immunosuppressive drug therapy, or the animal is a reservoir host for the given *Bartonella* species. Difficulties in detecting *Bartonella* infection in the blood of non-reservoir sick animals are most likely a reflection of extremely low numbers of circulating *Bartonella* organisms (Breitschwerdt et al., 2000; Gouriet et al., 2005; Gundi et al., 2004; Rolain et al., 2001; Rolain et al., 2002). To date, alternative methods of isolation have proven to be of little diagnostic utility; further, no appropriate liquid medium to support the growth of several clinically important *Bartonella* species had been characterized. Previous reports have described the growth of one or a few *Bartonella* species from relatively well-defined, human diagnostic specimens and isolation of *Bartonella* species from experimentally infected cats (Chenoweth et al., 2004; Fournier et al., 2002c; La Scola et al., 1999).

Alternative microbiological methods

Historically, our research group has often failed to isolate *Bartonella* species from the blood of sick dogs with serological, pathological, or molecular evidence of active infection (Breitschwerdt et al., 1999; Pappalardo et al., 2000b). As part of a veterinary diagnostic service, our laboratory routinely used traditional, commercially available blood

agar plates (trypticase soy agar with 5% rabbit blood) to isolate *Bartonella* organisms from the blood of dogs, cats, horses, and other animals. A review of diagnostic results and medical records indicated that the conventional method used for *Bartonella* isolation was quite inefficient with respect to the culture of *Bartonella* species from dog blood. From June 1997 to December 2004, more than 200 cultures were performed to assist in the diagnosis of *Bartonella* infection in dogs; of these isolation attempts, only three resulted in the successful isolation of *Bartonella* species (3/210 total cultures or 1.4%). Of the 119 cultures completed during the same time period using cat blood, seven culture attempts (7/119 total cultures or 5.9%) successfully isolated *Bartonella* species. Following the review of these data and our previous case experiences, we hypothesized that the detection and isolation of *Bartonella* in clinical samples, collected from dogs, could be enhanced by pre-enrichment in liquid BAPGM prior to blood agar plating when compared to traditional diagnostic methods.

After careful review of the literature for growth requirements, biochemical constituents, and amino acid supplements for bacteria in general and *Bartonella* specifically, various commercially available, insect and mammalian cell culture medias, such as Hink's, Grace's, DS2®, RPMI, and IPL41, were evaluated in an attempt to provide the optimal and most efficient growth medium for several clinically relevant *Bartonella* species. Various combinations and much iteration culminated in the development and characterization of a novel, chemically modified, insect-based liquid culture medium that supported the growth of at least seven *Bartonella* species and several co-cultures with combinations of two different *Bartonella* species (Maggi et al., 2005a). Further, this

liquid, pre-enrichment media, referred to as *Bartonella*/alpha-*Proteobacteria* Growth Medium (BAPGM), facilitated the primary isolation of *B. henselae* from blood and aqueous fluids of naturally infected cats in half the time generally required when using a conventional isolation media (e.g., sheep blood agar plate or chocolate agar plate) (Maggi et al., 2005a). It is important to note that isolates were not obtained from these two clinical samples by direct inoculation of a blood agar plate, which is consistent with the limited sensitivity of conventional isolation approaches for the detection of *B. henselae* and other *Bartonella* species.

Although BAPGM aided in agar plate isolation of *B. henselae* from cats, the successful use of BAPGM for the isolation of *Bartonella* organisms from dog blood was much more difficult to achieve. Additional optimization of the liquid media, including changes in the insect cell-culture base media and amino acid supplementation, along with different incubation conditions were required to successfully isolate *Bartonella* from clinical samples collected from dogs. The incorporation of minor modifications to our previously reported BAPGM pre-enrichment medium facilitated the molecular detection and isolation of single and co-infections of *Bartonella* species in blood samples obtained from sick dogs (Duncan et al., 2007). Ultimately, the optimized approach for the detection and isolation of *Bartonella* species required the combination of pre-enrichment culture followed by molecular detection (Duncan et al., 2007, Maggi et al., 2005b). Using this approach, *Bartonella* species were detected in 19 of 148 blood samples (12.8%) from sick dogs tested; further, we detected three co-infections with *B. henselae* and *B. vinsonii* (*berkhoffii*), and for the first time, two dogs were found to be infected with *B. bovis*. Also,

Bartonella isolates were obtained from six dogs using this combined approach of pre-enrichment culture and sub-inoculation onto agar plates (Duncan et al., 2007).

Summary

Hypothesizing that traditional microbiological methods were not adequate to successfully isolate *Bartonella* species from clinical samples from dogs, a pre-enrichment medium, based on a formulation that promotes the growth of insect cells in culture, was developed and characterized. This novel media, referred to as *Bartonella/alpha-Proteobacteria* Growth Medium (BAPGM), supported the isolation and growth of at least seven individual *Bartonella* species and co-cultures of more than one *Bartonella* species. The utility of BAPGM and its remarkable improvement in the detection and isolation of *Bartonella* species from naturally infected populations represents a significant contribution to the worldwide research efforts to enhance the growth, molecular detection, and maintenance of these fastidious bacteria. The improved isolation methods should assist in the understanding of the diversity, adaptation, and epidemiology of *Bartonella* species, and also provide substantial aid in evaluating the causal link between the presence of *Bartonella* and disease manifestations.

Potential link between chronic bacterial infection and cancer

Introduction

Oncogenesis is a multistep process which results in an overall disturbance in the regulation of cell growth and subsequently forces the progressive transformation of normal

cells into malignant derivatives (Hanahan et al., 2000). Briefly, initiation involves mutations in proto-oncogenes, tumor suppressor genes, and/or other genes that are important in the regulation of cell growth and apoptosis. After transformation to a neoplastic phenotype, proliferation and invasion must occur. Many genetic and environmental factors contribute to oncogenesis; environmental factors such as toxins or radiation can cause DNA damage, which results in malignant transformation and cancer. During the past decade, researchers have provided an expanding body of evidence to support a potential role for infectious agents such as viruses, mycoplasma, bacteria, and protozoa, as cofactors in the development of cancer in humans (Lax et al., 2002). In fact, the World Health Organization recently estimated that one-fifth (20%) of all cancers worldwide are caused by chronic infection with a virus, bacteria, or protozoa (WHO 2006).

Viral agents and oncogenesis

It is well established that viruses cause malignant transformation of DNA that can result in the development of neoplasia. Epstein-Barr virus (EBV), discovered in 1964 in a Burkitt's lymphoma biopsy, was the first virus to be directly linked with human cancer. Since its discovery, EBV has been associated, either as the principal etiologic agent or as a necessary or contributing co-factor, with several malignancies including Burkitt's lymphoma (a childhood tumor common in sub-Saharan Africa), Hodgkin's disease (a lymphoproliferative disorder of B-lymphocytes), lymphomas and other lymphoproliferative diseases in immunocompromised patients, and nasopharyngeal and

gastric carcinoma. As a ubiquitous human herpesvirus, serosurvey results indicate that at least 90% of adults worldwide are exposed to and actively infected with EBV; however, the cancers associated with herpes viral infection are relatively rare (Hsu et al., 2000). Hypothetically, EBV has evolved to exploit the process of B-cell development, and this exploitation allows EBV to maintain a chronic, but asymptomatic, infection. Neoplastic events associated with EBV infection typically occur after many years of viral dormancy and are accompanied or prompted by reactivation of the virus (Pagano 1999).

Other viral agents have been implicated in oncogenesis. In numerous epidemiological studies, chronic hepatitis B virus (HBV) and hepatitis C virus (HCV) infections have been associated with hepatocellular carcinoma. A meta-analysis of 32 studies published between 1993 and 1997 reported summary odds ratios of 13.7 (95% confidence interval = 12.2 to 15.4) and 11.5 (95% confidence interval = 9.9 to 13.3) for the development of hepatocellular carcinoma among people chronically infected with HBV and HCV, respectively (Donato et al., 1998). For HBV, hepatocellular carcinoma typically emerges after 30 years of chronic infection, during which time, liver cells undergo progressive changes as a consequence of ongoing viral replication. After many recombination events, HBV DNA becomes integrated into the DNA of the host. It is hypothesized that these integrated viral DNA sequences contribute to development of cancer. In contrast, HCV is an RNA virus, and therefore, does not integrate into host cell DNA; the mechanisms by which HCV causes liver cancer have not been elucidated (NTP 2005).

Some human papillomaviruses (HPVs) have also been strongly implicated as a cause of cancer, specifically cervical cancer. In an extensive study of more than 1,000 invasive cervical cancer tissue samples collected from women in 22 different countries, HPV was detected in 99.7% of all cervical carcinomas; this value represents the highest, worldwide attributable fraction reported to date for a specific cause of a major human cancer and is suggestive that HPV infection may be necessary for the development of cervical cancer (Walboomers et al., 1999). More than 100 types of HPV have been identified. Papillomaviruses can cause cutaneous infection (skin warts) or genital-mucosal infection; those causing genital-mucosal infection may be classified as low-risk or high-risk genotypes. Low-risk types are non-oncogenic and are associated with anogenital warts or low-grade cervical dysplasia. High-risk, oncogenic types have been associated with cervical cancer and low- and high-grade dysplasias. During the progression to a neoplastic phenotype, viral DNA is thought to integrate into the host genome, although the pathways for HPV in oncogenesis are not fully understood (NTP 2005).

Also implicated in oncogenesis, human retroviruses are known to target cells of the immune system, particularly mature CD4⁺ T cells. This type of selection results in either impairment of cell function and abnormal growth, as shown by human T-cell leukemia virus (HTLV), or cell death, as demonstrated in human immunodeficiency virus (HIV).

Human T-cell leukemia virus type 1 (HTLV-1) is a member of the Deltaretrovirus family and is the etiologic agent of adult T-cell leukemia, an aggressive malignancy of mature CD4⁺ T cells. Approximately 10 to 20 million HTLV-1 carriers exist worldwide, and HTLV-1 is endemic in Japan and in parts of central Africa, the Caribbean, and South

America (Edlich et al., 2000). Despite this global endemnicity, only approximately 5% of HTLV-1 carriers develop adult T-cell leukemia, indicating that most carriers remain asymptomatic over their lifetime, as indicated in both prospective cohort and longitudinal studies (Arisawa et al., 2000; Arisawa et al., 2003; Arisawa et al., 2006).

HTLV-1 is a highly cell-associated virus and efficient transmission requires transfer of infected cells and cell-to-cell contact (Matsuoka 2005). The major route of transmission is from mother to infant via infected breast milk, however, sexual transmission (primarily male to female) and parenteral transmission (through transfusion of infected blood products or intravenous drug use) may also occur (Jarrett 2006; Matsuoka 2005).

Similar to other retroviruses, following infection of a cell with HTLV-1, the RNA genome is transcribed into DNA and integrates into the host's chromosomal DNA (Goff 2001). Upon integration, cellular infection is interminable, and the viral genome is passed to daughter cells. Mitotic division of infected cells appears to be the primary expansion route of HTLV-1, as viral transmission is relatively inefficient (Jarrett 2006).

The HTLV-1 provirus has a similar structure to other retroviruses and also has an important region that encodes for several accessory genes; among these, the *tax* gene plays key roles in viral gene transcription, viral replication, and the clonal proliferation of HTLV-1-infected cells (Matsuoka 2005). Further, this multifunctional protein interacts with transcription factors and molecules involved in signal transduction pathways, resulting in dysregulation of viral and cellular genes involved in cell cycle control,

apoptosis, and DNA repair (Franchini et al., 2003; Gatzka et al., 2005; Jeang et al., 2004; Kawakami et al., 2005).

The ability of HTLV-1 to stimulate T-cell proliferation and the pleiotropic properties of the Tax protein suggest an obvious mechanism by which this retrovirus causes T-cell leukemia; however, a contradiction becomes readily apparent, considering the majority of adult T-cell leukemia cases demonstrate no evidence of Tax expression (Matsuoka 2005). The inactivation of Tax expression results from mutations, insertions, or deletions of the *tax* gene, DNA methylation of the 5' long terminal redundancy (LTR) sequences, and/or epigenetic deletion of the 5' LTR (Takeda et al., 2004; Tamiya et al., 1996). Therefore, the current model of adult T-cell leukemia pathogenesis includes initial infection by HTLV-1, which results in Tax expression and polyclonal expansion of infected CD4+ cells. At this stage, proliferation is controlled by the cytotoxic T-lymphocyte response, a response which is targeted to the Tax protein (Jarrett 2006; Matsuoka 2005). Over a latency period of approximately 60 years, proliferation and Tax expression lead to accumulating genetic and epigenetic alterations of the host genome, which subsequently transform the HTLV-1-infected cells into adult T-cell leukemia cells, and also enable adult T-cell leukemia cells to proliferate in the absence of Tax expression, culminating in the onset of adult T-cell leukemia (Jarrett 2006; Matsuoka 2005).

The human immunodeficiency virus (HIV) is a lentivirus of the retrovirus family and replicates using a DNA intermediate which integrates into host cell chromosomal DNA (Goff 2001). Infection is characterized by a specific deficiency in CD4+ cells, coupled with the persistent stimulation of B cells. When compared to the general

population, HIV patients are at a significantly increased risk for the development of many types of cancer, particularly at the later stages of infection, including the progression to AIDS. Since the onset of the HIV/AIDS epidemic, several AIDS-defining cancers have been defined and include malignancies such as Kaposi's sarcoma, a rare neoplasm, and non-Hodgkin's lymphoma (CDC 1993).

Kaposi's sarcoma, a vasculoproliferative disorder triggered by human herpesvirus 8, is one of the most frequently observed neoplasms in HIV-infected patients. Despite a substantial decline in incidence with the routine administration of highly active antiretroviral therapy, AIDS-related Kaposi's sarcoma persists in the immunocompromised population (Ledergerber et al., 1999; Rabkin 2001; Von Roenn 2003). An angioproliferative hyperplasia that utilizes both autocrine and paracrine growth loops to stimulate progression to a highly angiogenic sarcoma, the disease is often multifocal in distribution and has been reported in skin, mucosae, lymph nodes, and nearly all organs (Jacobson et al., 1995; Miles 1994; Nasti et al., 1997). Histologically, Kaposi's sarcoma presents as an angioproliferative disease characterized by neoangiogenesis, infiltration of lymphocytes, plasma cells, and macrophages, and proliferating spindle-shaped cells, the hallmark of the tumor (Ensoli et al., 1998).

The uniquely high incidence of Kaposi's sarcoma in HIV-infected patients suggests a more active role for the HIV virus itself in the etiological process of tumorigenesis. The Tat protein is a HIV-1 regulatory protein, which is released by infected cells and shares several functional characteristics of the previously described HTLV-1 *tax* as a transactivating factor (Blattner 1999). The Tat protein directly modulates the growth and

phenotypic characteristics of the tumorigenic endothelial cells involved in Kaposi's sarcoma (Gallo 1998; Gallo 1999). Further, Tat allows Kaposi's sarcoma cells to evade apoptosis (Deregibus et al., 2002) and stimulates the growth of the characteristic spindle cells by way of inflammatory cytokines (Barillari et al., 2002).

Non-Hodgkin's lymphoma is a second commonly observed neoplasm in HIV-infected patients. Evidence from epidemiological studies indicates that HIV infection dramatically increases the risk of non-Hodgkin's lymphoma, and risk estimates range from 14 (low-grade non-Hodgkin's lymphoma) to 350 (high-grade non-Hodgkin's lymphoma) times the risk rate found in the general population (Franceschi et al., 1999; Grulich et al., 1999). Similar to the reduction in incident cases of Kaposi's sarcoma with the advent of highly active antiretroviral therapy, a meta-analysis of 23 cohort studies demonstrated a decline in HIV-related, non-Hodgkin's lymphoma from 1992-1996 (0.62% per year) to 1997-1999 (0.36% per year) (International Collaboration on HIV and Cancer 2000). As lymphoma generally occurs late in the course of HIV infection, several pathogenic mechanisms are hypothesized to be important in its development, such as persistent antigenic stimulation, genetic abnormalities, and severe, HIV-induced immunosuppression (Gates et al., 2003).

Immunocompromised patients, particularly those infected with HIV, are predisposed to develop opportunistic, vasoproliferative, tumor-like lesions, known as bacillary angiomatosis, a syndrome characterized by skin lesions, and peliosis hepatis, a rare hepatic lesion (Slater et al., 1992). In the early 1990s, these types of lesions catapulted the significance of *Bartonella* infections in immunocompromised individuals when PCR

was used to amplify *Bartonella* DNA from bacillary angiomatosis lesions (Relman et al., 1990) and Warthin-Starry staining bacteria were detected in patients with peliosis hepatis (Perkocha et al., 1990).

Bacillary angiomatosis may be induced by *B. quintana* and *B. henselae* infections (Brouqui et al., 2006; Clarridge et al., 1995; Koehler et al., 1992; Koehler et al., 1997; Turgut et al., 2004). Various organs may be affected, including the liver, spleen, bone marrow, and lymph nodes; however, bacillary angiomatosis most often affects the skin and may be attributed to the preference of *B. henselae* and *B. quintana* for endothelial cells (Dehio 2004; Koehler et al., 1997; Maurin et al., 1996; Meghari et al., 2006). The cutaneous lesions of bacillary angiomatosis are distinct in their morphology and may occur as solitary or multiple papules, warts, subcutaneous nodules, or hyperkeratotic plaques.

In immunocompromised patients with *B. henselae* infection, vasoproliferative lesions may also be observed in visceral parenchyma organs, and this condition is known as bacillary peliosis hepatis, splenic peliosis, or systemic bacillary angiomatosis (Koehler et al., 1997; Perkocha et al., 1990; Reed et al., 1992). Bacillary peliosis is characterized by vascular proliferation primarily in the liver and spleen, resulting in the formation of blood-filled cysts (Slater et al., 1992; Tappero et al., 1993b). Analogous to bacillary angiomatosis, bacillary peliosis is found in association with proliferating endothelial cells (Manders 1996).

Similar morphological and histopathological features are observed between bacillary angiomatosis and bacillary peliosis. These lesions contain proliferating endothelial cells, *Bartonella* bacteria, and inflammatory infiltrates. Histologically, features

include a tumor-like growth pattern, lobular proliferations of capillaries, and endothelial cells in the lining and interstitium (Dehio 2004; Webster et al., 1992). The molecular mechanisms of *Bartonella*-induced neoangiogenesis, as observed in bacillary angiomatosis and bacillary peliosis, remain unclear. It is hypothesized that host-derived vasoproliferative factors, such as vascular endothelial growth factor (VEGF), are important contributors to the pathogenesis of angiomatosis, where the proliferation of endothelial cells is a consequence of *Bartonella* infection (Dehio 2001; Dehio 2004; Welch et al., 1992).

Bacterial agents and oncogenesis

Similar to viral agents, several bacterial toxins interfere with cellular signaling pathways linked to apoptosis which alters the regulation of cell growth, and thus could provide a paradigm for bacterial involvement in oncogenesis (Lax et al., 2002). However, unlike viruses which use direct mechanisms, such as DNA integration and oncogene expression to promote neoplasia, the pathways for bacterial involvement in oncogenesis are not well defined.

Bartonella species infection has been reported in human patients with cancer (Liston et al., 1996). A *Bartonella*-like infection was hypothesized as the etiologic agent of Hodgkin's disease in a recent case report, during which a lymphoid tumor in the lung of a patient with Hodgkin's disease resolved completely following prolonged antibiotic

treatment; the patient was in complete remission after a 2-year, follow-up period (Sauter et al., 2003; Sauter 1995).

***Helicobacter pylori* and cancer.** A role for bacteria in carcinogenesis was first discovered when chronic infection with *Helicobacter pylori*, a bacterium identified in the stomach lining of patients with chronic gastritis and peptic ulcers, was associated with an increased risk of gastric adenocarcinoma and a specific type of B-cell lymphoma called mucosa-associated lymphoid tissue (MALT) lymphoma (Parsonnet et al., 1991; Wotherspoon et al., 1991). Case-control studies have determined that infection with *H. pylori* is associated with the development of gastric adenocarcinoma (Siman et al., 1997; Uemura et al., 2001). Chronic *Helicobacter* infection is involved in the activation of several signal transduction pathways linked to carcinogenesis, and *Helicobacter* species have also been shown to dysregulate cell cycle control, inhibit apoptosis, and produce several pro-inflammatory cytokines and reactive oxygen species that may contribute to oncogenesis (Jüttner et al., 2003; Naito et al., 2002). Although the molecular mechanisms for *H. pylori* carcinogenesis have not been fully elucidated, chronic inflammation, accompanied by release of oxygen free radicals, resulting in DNA damage and transformation of gastric epithelial cells to a neoplastic phenotype has been proposed. Various antibiotic regimens are available that eradicate *H. pylori* infection in 80 to 90% of patients, and in its early stages, MALT lymphoma is an antibiotic-responsive neoplastic process that is completely reversible in some patients following therapeutic elimination of

the *H. pylori* infection (Bayerdorffer et al., 1995; Chen et al., 2005; Isaacson et al., 2004; Morgner et al., 2001).

Though not as well characterized as *H. pylori* infection, other links between chronic bacterial infections and oncogenesis have been described, such as *Salmonella typhi* and hepatobiliary carcinoma, *Campylobacter jejuni* and MALT lymphoma, and *Chlamydia psittaci* and ocular lymphoma (Caygill et al., 1995; Ferreri et al., 2004; Lecuit et al., 2004). Despite the uncertainty of the precise molecular mechanisms involved, there is increasing evidence that chronic infection with *H. pylori* and other bacterial organisms may contribute to various processes that initiate neoplastic transformation (Lax et al., 2002).

***Bartonella* species and angiogenic tumorigenesis.** In addition to causing DNA damage secondary to inflammation, bacterial pathogens may initiate or contribute to tumorigenesis by modulating specific cellular pathways to ensure their survival. Mechanisms include inducing cellular proliferation and angiogenesis, inhibiting apoptosis, or altering expression of cell-adhesion molecules that may enhance metastasis (Lax et al., 2002; Simiantonaki et al., 2002). As angiogenesis is an important component of both tumor cell proliferation and metastasis, abnormal endothelial cell growth provides a rational link between bacterial infection and the development of neoplasia (Kempf et al., 2002; Lax et al., 2002; Wong et al., 2001). Angiogenesis is the process of capillary or blood vessel formation by sprouting of pre-existing vasculature; although a normal process in growth and development, angiogenesis is also a fundamental step in the progressive transformation of tumors to a malignant state. Recently, researchers have focused on the

vasoproliferative or immunomodulatory properties of three human pathogenic *Bartonella* species, *B. bacilliformis*, *B. quintana*, and *B. henselae*, as potential contributors to an antibiotic-responsive, reversible, oncogenic process. Based on a plausible molecular pathogenesis of endothelial cell proliferation and angiogenesis, several *Bartonella* species are considered to be bacterial pathogens capable of causing or contributing to carcinogenesis (Kempf et al., 2002; Lax et al., 2002).

Currently, *Bartonella* species are one of only a few (e.g., *Rickettsia rickettsii*) bacterial pathogens that are able to invade endothelial cells. *Bartonella* species subsequently colonize vascular tissues, resulting in the induction of angiogenic tumorigenesis. Early observations of similarities between the vasoproliferative lesions induced by cancer and those attributed to *Bartonella* species have been reported; these descriptions focused primarily on the endothelial proliferative tumors, bacillary angiomatosis, bacillary peliosis, and peliosis hepatis, which were initially considered to be malignancies associated with HIV infection, but are now known to be the result of *Bartonella* infection. However, very little is known regarding the mechanisms by which *Bartonella* species are able to cause vascular endothelial cell proliferation. Theoretically, *Bartonella* species can drive angioproliferation by at least two independent, but additive, mechanisms: (1) directly, by initiating proliferation and inhibiting apoptosis of endothelial cells, and (2) indirectly, by inducing an angiogenic paracrine loop of vasculoproliferative factors, such as interleukin (IL)-8 and vascular endothelial growth factor (VEGF), which are released from infected host cells (Dehio 2003; Dehio 2004; Kempf et al., 2002).

Direct mechanisms of angioproliferation. In experimental models, *B. bacilliformis* and *B. henselae* have been shown to directly induce angiogenesis and endothelial cell proliferation *in vitro*; further, in these studies, the absolute numbers of *Bartonella* organisms increased, suggesting an overall survival advantage within this environment (Garcia et al., 1990; Kempf et al., 2001). *Bartonella bacilliformis* was shown to induce the formation of new blood vessels in an *in vivo* model of angiogenesis (Garcia et al., 1990). Co-culture of *B. henselae* or *B. quintana* with endothelial cells resulted in increased rates of endothelial cell proliferation (Conley et al., 1994). In natural infections, vasoproliferative disorders are recognized in humans infected with *Bartonella* bacteria: *B. bacilliformis* and verruga peruana, *B. henselae* and *B. quintana* and bacillary angiomatosis and bacillary peliosis, and *B. henselae* and peliosis hepatis. Of comparative medical importance, there is also a case report of peliosis hepatis in a dog infected with *B. henselae* (Kitchell et al., 2000).

Programmed cell death, or apoptosis, is a crucial pathway used to destroy malignantly transformed cells, thereby not allowing proliferation and progression to a tumorigenic state (Lax et al., 2002). Chronic, intracellular bacteria, such as *Bartonella*, are often able to disrupt this apoptotic process, providing a unique means for pathogen survival within the host cell. Modulation of normal host cell signaling pathways is fundamental to the development or inhibition of tumorigenesis. *In vitro*, *Bartonella* species, specifically *B. henselae* and *B. quintana*, have been shown to inhibit apoptosis of endothelial cells when compared to uninfected endothelial cells used as controls (Kirby et al., 2002). An approximate two-fold increase in viability was observed in *Bartonella*-

treated endothelial cells, and this increase was attributed to the anti-apoptotic activity of *Bartonella*. Additionally, three non-angiogenic species, *B. vinsonii* (*vinsonii*), *B. vinsonii* (*arupensis*), and *B. elizabethae*, did not inhibit apoptosis (Kirby et al., 2002). This anti-apoptotic effect, shown to be specific for endothelial cells, may be interceded to some extent by VEGF, an important signaling protein involved in angiogenesis, which is also known to protect cells from apoptosis (Greub et al., 2002). Overall, organism-induced, anti-apoptotic activity allows for the evasion of a non-specific host defense mechanism and facilitates enhanced survival of endothelial cells, thereby protecting the endothelial cells for the maintenance and proliferation of *Bartonella*. Inhibition of apoptosis is likely a contributing factor to the development of *Bartonella*-induced angioproliferative lesions.

Indirect mechanisms of angioproliferation

Vascular endothelial growth factor. As similar pathologic changes, including endothelial cell proliferation, are frequently observed between neoplasia and infection, increased levels of VEGF may act a common mediator. As a highly specific and effective mitogen, VEGF is important for normal endothelial cell physiology; it is secreted directly by neoplastic cells and by macrophages activated by infection or inflammation (Carmeliet et al., 2000; Ferrara et al., 2001; Konig et al., 1999). Excessive production of VEGF has proven to be an important link between bacterial proteins and abnormal endothelial growth and also between *Bartonella* and oncogenesis (Kempf et al., 2002; Lax et al., 2002; Wong et al., 2001). *Bartonella*-induced VEGF production, resulting in endothelial cell

proliferation, has been demonstrated *in vitro* (Kempf et al., 2001; Maeno et al., 1999; Verma et al., 2001). In one study, anti-VEGF monoclonal antibodies reduced *Bartonella*-activated endothelial cell proliferation by 50% (Kempf et al., 2001). Other *in vitro* models of endothelial cell angiogenesis have demonstrated increased VEGF production within 24 hours of exposure to *Bartonella* (Resto-Ruiz et al., 2002; Resto-Ruiz et al., 2003). Further, *B. henselae*-stimulated macrophages were shown to induce endothelial cell proliferation (McCord et al., 2005). In a mouse melanoma model, increased VEGF levels were associated with hepatic lesions, characterized by severe sinusoidal dilation and endothelial cell proliferation and apoptosis, which were histologically similar to those observed in human patients with *B. henselae* infection and peliosis hepatis (Wong et al., 2001). *In vivo*, increased levels of VEGF expression have been detected in vasoproliferative lesions of HIV patients who were PCR positive for *B. henselae* DNA; these increased levels of expression were observed when compared to vasculoproliferative Kaposi's sarcoma stained with a VEGF-specific antibody (A-20) as a positive control and with an irrelevant antibody (anti-*Y. enterocolitica*, polyclonal) as a negative control (Kempf et al., 2001).

Paracrine loop model. *Bartonella* share a close evolutionary homology with the genus *Agrobacterium*, an important genus of plant pathogens. Of particular interest are the tumorigenic similarities between crown gall tumors in injured plants and bacillary angiomatosis in immunocompromised people, as well as the comparative pathogenic mechanisms of *B. henselae* and *A. tumefaciens*. The tumor mechanism of *A. tumefaciens* in plants is mediated by the "opine concept". Upon injury, plant cells produce certain

phenolic substances, such as acetosyringone, that act as signaling molecules, triggering a type IV secretion system known as VirB-D4. Sensing these “injury signals”, *A. tumefaciens* attaches itself to the plant cell and utilizes the VirB-D4 system to transfer part of its tumor-inducing plasmid into the plant cell nucleus, a fundamental step in crown gall tumor initiation. When influenced by the products of the *vir* genes, the bacterial cell produces a single-stranded linear DNA molecule (transfer DNA), which is first transferred to the plant cell nucleus, is nonspecifically inserted into one of the chromosomes, and becomes stably integrated into the plant genome. Subsequently, expression of the genes encoded by the transfer DNA results in the proliferation of plant hormones; the plant cells proliferate without restraint and crown gall tumors form. Crown gall tumors produce tumor-specific compounds, called opines. These substances serve as sources of carbon and nitrogen for *Agrobacterium* species, but are not readily metabolized by other soil microorganisms. This complex, multi-faceted process uses genetic modification of the host plant cells to create a favorable environment for an invading bacterium, *A. tumefaciens*, to persist and reproduce (Chen et al., 2002; Cho et al., 2005; Chumakov et al., 2002; Hooykaas et al., 1994; Kempf et al., 2002).

Based on the striking similarities between *A. tumefaciens*-induced crown gall tumors and the induction of vasoproliferative tumors by *B. henselae*, a model similar to the “opine concept” has been proposed for *B. henselae*, and has been described as a paracrine angiogenic loop model (Dehio 2003; Dehio 2004; Kempf et al., 2002; Resto-Ruiz et al., 2002). Similar to *A. tumefaciens*, it is known that *B. henselae* is able to adhere to and invade host cells, particularly endothelial cells and macrophages (Dehio 2004). Further,

after infection, both organisms activate the production of host cell-derived growth hormones; *A. tumefaciens* stimulates auxins and cytokinins, while *B. henselae* triggers VEGF and IL-8. Bacterial-induced, hormone release results in the proliferation of the preferred cellular niche, plant cells and endothelial cells, for *A. tumefaciens* and *B. henselae*, respectively. The resultant uninhibited, tumorigenic cell growth causes the characteristic lesions associated with *B. henselae* infection, bacillary angiomatosis and bacillary peliosis, and the crown gall tumors found in plants infected with *A. tumefaciens*. Lastly and perhaps most intriguing, both tumors types are able to promote bacterial replication through cellular proliferation (endothelial cells or plant cells); this mechanism induces tumor growth, which facilitates the perpetuation of their respective species. Crown gall tumors produce opines as a source of nutrition for the tumor and for the bacteria, thereby supporting the replication of *A. tumefaciens*. Although the specific mechanisms utilized by *B. henselae* to promote growth are currently unknown, the close evolutionary relationship of *A. tumefaciens* and *B. henselae* suggests that these two pathogens may share a common survival strategy in injured plants or immunocompromised human beings (Kempf et al., 2002).

In the paracrine loop model of *Bartonella*-induced vasoproliferation, macrophages represent a second, and perhaps more important, target effector cell for *B. henselae* adhesion and invasion. Activated macrophages are able to produce and release potent angiogenic factors, such as VEGF and IL-8, which contribute in a paracrine manner to drive endothelial cell proliferation. *Bartonella henselae* may further enhance endothelial cell proliferation by stimulating IL-8, thereby activating chemotactic migration of

additional macrophages (Dehio 2004; Kempf et al., 2001; McCord et al., 2005; Resto-Ruiz et al., 2002; Resto-Ruiz et al., 2003). When a human macrophage cell line was experimentally infected with *B. henselae*, both VEGF and IL-1 β , a potentiator of VEGF, were released (Resto-Ruiz et al., 2002). *Bartonella henselae* has also been shown, *in vitro*, to upregulate a chemokine released from endothelial cells, monocyte-macrophage chemoattractant-1; this release mediates monocyte and macrophage infiltration to the site of infection and promotes angiogenesis through active recruitment of effector cells (McCord et al., 2005). Lastly, when compared to activated inflammatory cells, such as macrophages, endothelial cells are typically considered poor producers of VEGF, and no evidence of *B. henselae* stimulating an autocrine loop of VEGF-mediated endothelial proliferation has been reported (Dehio 2004; Kempf et al., 2001; Maeno et al., 1999; Resto-Ruiz et al., 2002).

***Bartonella* Type IV secretion systems**

Many of the pathogenic mechanisms associated with *Bartonella* infections are mediated by a type IV secretion system. Utilized by many bacterial pathogens, type IV secretion systems are molecular transport machineries that are involved in the translocation and delivery of bacterial effector molecules, primarily virulence factors, during the interaction with host cells (Cascales et al., 2003; Dehio 2004; Schroder et al., 2005).

Agrobacterium tumefaciens utilizes a type IV secretion system, the VirB-D4 system, to form a pilus and pore complex spanning both bacterial membranes and most likely the host

cell membrane as well. This complex acts as a needle and syringe to “inject” a nucleoprotein complex (i.e., the tumor-inducing plasmid) from the bacterial cytoplasm into the plant cell cytoplasm (Dehio 2004; Schroder et al., 2005). Another human pathogen, *Helicobacter pylori* uses a type IV secretion system, the Cag system, to transport proteins into the gastric epithelial cells; this transfer results in morphological changes in the host cell through the modulation of several important signal transduction pathways (Cascales et al., 2003; Dehio 2004; Nagai et al., 2003; Schroder et al., 2005).

Mediating the transfer of virulence factors into host cells, *Bartonella* species encode two different type IV secretion systems, VirB-VirD4 and Trw; both systems are necessary for infection, cell entry, and host cell interactions that are associated with different stages or different routes of infection. Further, a set of seven VirB-D4-translocated substrates, known as *Bartonella*-translocated effector proteins, have been recently identified, making the VirB-D4 system part of a *Bartonella*-specific pathogenicity island (Dehio 2004; Schroder et al., 2005; Schulein et al., 2002; Schulein et al., 2005; Seubert et al., 2003).

Based on *in vitro* studies and rodent models of *Bartonella* infection, the colonization and activation of endothelial cells by *Bartonella* is mediated by the VirB-D4 type IV secretion system, as indicated by several VirB-dependent changes, including: (1) massive actin cytoskeletal rearrangement resulting in the aggregation and uptake of the bacteria by a unique host-cellular structure, known as the invasome; (2) induction and modulation of a pro-inflammatory response; (3) increased cell survival through the inhibition of apoptosis; and (4) cytostatic or cytotoxic effects on endothelial cells at high

infection doses (Dehio 2003; Dehio 2004; Schmid et al., 2004; Schroder et al., 2005; Schulein et al., 2002).

Translocated by the VirB-D4 type IV secretion system, the set of *Bartonella*-translocated effector proteins are required for invasion, pro-inflammatory activation, and anti-apoptotic protection of endothelial cells (Schulein et al., 2005). Deletion of the genes encoding all effectors resulted in the loss of the VirB-D4 phenotypes described in the previous paragraph (Schulein et al., 2005). Therefore, it is hypothesized that these seven proteins are the molecular effectors that mediate the VirB-D4-dependent responses in *Bartonella*-infected endothelial cells, thereby enabling *Bartonella* to colonize the endothelium (Schroder et al., 2005). It should be noted that the VirB-*Bartonella* effector proteins that comprise the pathogenicity island have been identified in both *B. henselae* and *B. quintana* genomes, but not in any other published genome sequence (Schulein et al., 2005).

The second type IV secretion system discovered in *Bartonella*, Trw, is also an essential virulence factor, although the function of this system is not fully defined. In a rodent model, the Trw system was required for intraerythrocytic *Bartonella* infection, and deletion of the required *trw* gene resulted in a short-term infection with rapid clearance of *Bartonella* from the blood (Seubert et al., 2003). Based on these findings, the Trw system may not be necessary for the initial infection of endothelial cells, but may be required for erythrocyte colonization and/or for intraerythrocytic replication (Schroder et al., 2005). Although the Trw system encodes all components needed for the pilus and pore complex, it lacks the VirD4 homolog, a coupling protein required for the secretion of dedicated type

IV secretion system substrates (Cascales et al., 2003; Dehio 2004). In contrast to the VirB-*Bartonella* effector proteins complex, currently, no substrates are known to be translocated by the Trw system. Due to the inability of Trw to translocate substances into host cells, researchers have surmised that the primary role of *Bartonella*'s Trw type IV secretion system is to produce variable bacterial surface structures, known as pili, that allow *Bartonella* bacteria to adhere to erythrocytes (Dehio 2004; Schroder et al., 2005). Further clarification of the precise function of the Trw type IV secretion system is needed.

Antibiotic therapy and the resolution of vasoproliferative or lymphoid tumors in *Bartonella*-infected individuals

Due to their chronic and intracellular course, *Bartonella* infections present a unique therapeutic challenge. Disease manifestations associated with infection are dependent on the specific *Bartonella* species and the immune status of the host. Because of the marked variations in clinical presentation, a single treatment for *Bartonella* infection has not been identified, and often the treatment course is adapted to each species and clinical situation (Jacomo et al., 2002).

In patients with *Bartonella*-associated infections, the minimal inhibitory concentration (MIC) levels of antibiotic compounds do not often correlate with the observed *in vivo*, clinical efficacy (Maurin et al., 1995). Hypothetically, these discrepancies and the general lack of several antibiotics to produce a bactericidal effect may be attributed to the various cellular niches, such as erythrocytes and endothelial cells,

that *Bartonella* species occupy within the human host (Rolain et al., 2004). Drug treatment of vasoproliferative tumors induced by *Bartonella* infection, specifically bacillary angiomatosis and peliosis hepatis, has not been studied systematically to date; the treatment course is often based on demonstrated successful therapy in case reports or case series with a few patients. Importantly, however, *Bartonella*-induced vascular proliferative diseases often completely resolve upon therapeutic elimination of the infecting *Bartonella* bacteria (Knobler et al., 1988; Koehler et al., 1988; LeBoit et al., 1988; Liston et al., 1996; Rudikoff et al., 1989; Stoler et al., 1983; Webster et al., 1992). Successful treatment of *Bartonella* infection is often achieved through the use of an antibiotic or combination of antibiotics with excellent *in vivo* activity against *Bartonella*, coupled with an extended duration of administration (i.e., at least 3 months) to prevent relapse (Rolain et al., 2004). Erythromycin is the antibiotic used most often to effectively treat vasoproliferative lesions associated with *Bartonella* infection (Koehler et al., 1993; Rolain et al., 2004; Stoler et al., 1983; Tappero et al., 1993b). Interestingly, it was recently reported that the remarkable efficiency of erythromycin to treat bacillary angiomatosis may be attributed to its inhibition of endothelial cell proliferation, or antiangiogenic effect, rather its antimicrobial effect (Meghari et al., 2006).

Summary

Oncogenesis is a multistep process which results in an overall disturbance in the regulation of cell growth and progression to a malignant phenotype. An expanding body

of evidence has developed over the last decade to support a potential role for infectious agents such as viruses, mycoplasma, bacteria, and protozoa, as cofactors in the development of cancer in humans. It well established that viruses cause malignant transformation of DNA that can result in the development of neoplasia. Similar to viral agents, several bacterial toxins interfere with cell growth and regulation, thereby potentially contributing to the development of cancer, although the pathways for bacterial involvement in oncogenesis are not well defined.

Helicobacter pylori was the first bacteria shown to cause cancer, specifically gastric adenocarcinoma and MALT lymphoma, in infected individuals. Subsequently, *Bartonella* species have been shown to modulate important cellular pathways that are involved in tumorigenesis, including mechanisms to induce cellular proliferation and angiogenesis, as well as inhibiting apoptosis. Based on a plausible molecular pathogenesis of endothelial cell proliferation and angiogenesis, several *Bartonella* species are considered to be bacterial pathogens capable of causing or contributing to carcinogenesis. Knowledge, gained through enhanced understanding of the mechanisms by which *H. pylori* and *Bartonella* species contribute to antibiotic-responsive MALT lymphoma and angioproliferative lesions such as bacillary angiomatosis and peliosis hepatis, respectively, may have far-reaching implications for the future treatment and prevention of cancer in animal and human patients.

Theoretically, *Bartonella* species can drive angioproliferation by at least two independent, but additive, mechanisms: (1) directly, by initiating proliferation and inhibiting apoptosis of endothelial cells, and (2) indirectly, by inducing an angiogenic

paracrine loop of vasculoproliferative factors, such as IL-8 and VEGF, which are released from *Bartonella*-infected host cells.

Bartonella share a close evolutionary homology with the genus *Agrobacterium*, an important genus of plant pathogens; further, several similarities, both mechanistically and phenotypically, are recognized between crown gall tumors in injured plants and bacillary angiomatosis in immunocompromised humans. A paracrine loop model, similar to the “opine concept” of *A. tumefaciens*-induced crown gall tumors, has been proposed for the vasoproliferative tumors observed with *B. henselae* infection.

Also similar to *A. tumefaciens*, *Bartonella* species utilize a type IV secretion system, VirB-VirD4, to mediate the transfer of virulence factors into host cells. An additional type IV secretion system, Trw, is also required for *Bartonella* infection, although the function of this second system is not fully elucidated. Further, a set of seven VirB-D4-translocated substrates, known as *Bartonella*-translocated effector proteins, have been recently identified, making the VirB-D4 system part of a *Bartonella*-specific pathogenicity island.

Due to their intracellular localization and chronic course, no single treatment for *Bartonella* infection has been identified, and often the treatment course is adapted to each species and clinical situation. Successful elimination of the *Bartonella* species often requires an extended course of antibiotic therapy to prevent relapse. It is important to note, however, that *Bartonella*-induced vascular proliferative diseases often completely resolve upon therapeutic elimination of the infecting *Bartonella* bacteria.

References

- Adelson, M.E., Rao, R.V., Tilton, R.C., Cabets, K., Eskow, E., Fein, L., Occi, J.L., Mordechai, E., 2004. Prevalence of *Borrelia burgdorferi*, *Bartonella* spp., *Babesia microti*, and *Anaplasma phagocytophila* in *Ixodes scapularis* ticks collected in northern New Jersey. *J. Clin. Microbiol.* 42 (6), 2799-2801.
- Alexander, B., 1995. A review of bartonellosis in Ecuador and Colombia. *Am. J. Trop. Med. Hyg.* 52 (4), 354-359.
- Amerein, M.P., De Briel, D., Jaulhac, B., Meyer, P., Monteil, H., Piemont, Y., 1996. Diagnostic value of the indirect immunofluorescence assay in cat scratch disease with *Bartonella henselae* and *Afipia felis* antigens. *Clin. Diagn. Lab. Immunol.* 3 (2), 200-204.
- Anderson, B., Kelly, C., Threlkel, R., Edwards, K., 1993. Detection of *Rochalimaea henselae* in cat-scratch disease skin test antigens. *J. Infect. Dis.* 168 (4), 1034-1036.
- Anderson, B.E., Neuman, M.A., 1997. *Bartonella* spp. as emerging human pathogens. *Clin. Microbiol. Rev.* 10 (2), 203-219.
- Arisawa, K., Sobue, T., Yoshimi, I., Soda, M., Shirahama, S., Doi, H., Katamine, S., Saito, H., Urata, M., 2003. Human T-lymphotropic virus type-1 infection, survival and cancer risk in southwestern Japan: A prospective cohort study. *Cancer Causes Control* 14 (9), 889-896.
- Arisawa, K., Soda, M., Akahoshi, M., Fujiwara, S., Uemura, H., Hiyoshi, M., Takeda, H., Kashino, W., Suyama, A., 2006. Human T-cell lymphotropic virus type-1 infection and risk of cancer: 15.4 year longitudinal study among atomic bomb survivors in Nagasaki, Japan. *Cancer. Sci.* 97 (6), 535-539.
- Arisawa, K., Soda, M., Endo, S., Kurokawa, K., Katamine, S., Shimokawa, I., Koba, T., Takahashi, T., Saito, H., Doi, H., Shirahama, S., 2000. Evaluation of adult T-cell leukemia/lymphoma incidence and its impact on non-Hodgkin lymphoma incidence in southwestern Japan. *Int. J. Cancer* 85 (3), 319-324.
- Avidor, B., Graidy, M., Efrat, G., Leibowitz, C., Shapira, G., Schattner, A., Zimhony, O., Giladi, M., 2004. *Bartonella koehlerae*, a new cat-associated agent of culture-negative human endocarditis. *J. Clin. Microbiol.* 42 (8), 3462-3468.
- Ayoub, E.M., McBride, J., Schmiederer, M., Anderson, B., 2002. Role of *Bartonella henselae* in the etiology of Henoch-Schonlein purpura. *Pediatr. Infect. Dis. J.* 21 (1), 28-31.

- Baker, J.A., 1946. A rickettsial infection in Canadian voles. *J. Exp. Med.* 84, 3750.
- Baneth, G., Breitschwerdt, E.B., Hegarty, B.C., Pappalardo, B., Ryan, J., 1998. A survey of tick-borne bacteria and protozoa in naturally exposed dogs from Israel. *Vet. Parasitol.* 74 (2-4), 133-142.
- Barillari, G., Ensoli, B., 2002. Angiogenic effects of extracellular human immunodeficiency virus type 1 tat protein and its role in the pathogenesis of AIDS-associated Kaposi's sarcoma. *Clin. Microbiol. Rev.* 15 (2), 310-326.
- Barnes, A., Bell, S.C., Isherwood, D.R., Bennett, M., Carter, S.D., 2000. Evidence of *Bartonella henselae* infection in cats and dogs in the United Kingdom. *Vet. Rec.* 147 (24), 673-677.
- Bass, J.W., Vincent, J.M., Person, D.A., 1997a. The expanding spectrum of *Bartonella* infections: I. Bartonellosis and trench fever. *Pediatr. Infect. Dis. J.* 16 (1), 2-10.
- Bass, J.W., Vincent, J.M., Person, D.A., 1997b. The expanding spectrum of *Bartonella* infections: II. Cat-scratch disease. *Pediatr. Infect. Dis. J.* 16 (2), 163-179.
- Bayerdorffer, E., Neubauer, A., Rudolph, B., Thiede, C., Lehn, N., Eidt, S., Stolte, M., 1995. Regression of primary gastric lymphoma of mucosa-associated lymphoid tissue type after cure of *Helicobacter pylori* infection. MALT lymphoma study group. *Lancet* 345 (8965), 1591-1594.
- Beldomenico, P.M., Chomel, B.B., Foley, J.E., Sacks, B.N., Baldi, C.J., Kasten, R.W., Gardner, I.A., 2005. Environmental factors associated with *Bartonella vinsonii* subsp. *berkhoffii* seropositivity in free-ranging coyotes from northern California. *Vector Borne Zoonotic Dis.* 5 (2), 110-119.
- Ben-Ami, R., Ephros, M., Avidor, B., Katchman, E., Varon, M., Leibowitz, C., Comaneshter, D., Giladi, M., 2005. Cat-scratch disease in elderly patients. *Clin. Infect. Dis.* 41 (7), 969-974.
- Bergmans, A.M., de Jong, C.M., van Amerongen, G., Schot, C.S., Schouls, L.M., 1997. Prevalence of *Bartonella* species in domestic cats in the Netherlands. *J. Clin. Microbiol.* 35 (9), 2256-2261.
- Bergmans, A.M., Groothedde, J.W., Schellekens, J.F., van Embden, J.D., Ossewaarde, J.M., Schouls, L.M., 1995. Etiology of cat scratch disease: Comparison of polymerase chain reaction detection of *Bartonella* (formerly *Rochalimaea*) and *Afipia felis* DNA with serology and skin tests. *J. Infect. Dis.* 171 (4), 916-923.

Bergmans, A.M., Schellekens, J.F., van Embden, J.D., Schouls, L.M., 1996. Predominance of two *Bartonella henselae* variants among cat-scratch disease patients in the Netherlands. *J. Clin. Microbiol.* 34 (2), 254-260.

Bermond, D., Boulouis, H.J., Heller, R., Van Laere, G., Monteil, H., Chomel, B.B., Sander, A., Dehio, C., Piemont, Y., 2002. *Bartonella bovis* Bermond et al. sp. nov. and *Bartonella capreoli* sp. nov., isolated from European ruminants. *Int. J. Syst. Evol. Microbiol.* 52 (Pt 2), 383-390.

Bermond, D., Heller, R., Barrat, F., Delacour, G., Dehio, C., Alliot, A., Monteil, H., Chomel, B., Boulouis, H.J., Piemont, Y., 2000. *Bartonella birtlesii* sp. nov., isolated from small mammals (*Apodemus* spp.). *Int. J. Syst. Evol. Microbiol.* 50 (Pt 6), 1973-1979.

Birtles, R.J., Canales, J., Ventosilla, P., Alvarez, E., Guerra, H., Llanos-Cuentas, A., Raoult, D., Doshi, N., Harrison, T.G., 1999. Survey of *Bartonella* species infecting intradomicillary animals in the Huayllacallan valley, Ancash, Peru, a region endemic for human bartonellosis. *Am. J. Trop. Med. Hyg.* 60 (5), 799-805.

Birtles, R.J., Harrison, T.G., Saunders, N.A., Molyneux, D.H., 1995. Proposals to unify the genera *Grahamella* and *Bartonella*, with descriptions of *Bartonella talpae* comb. nov., *Bartonella peromysci* comb. nov., and three new species, *Bartonella grahamii* sp. nov., *Bartonella taylorii* sp. nov., and *Bartonella doshiae* sp. nov. *Int. J. Syst. Bacteriol.* 45 (1), 1-8.

Blattner, W.A., 1999. Human retroviruses: Their role in cancer. *Proc. Assoc. Am. Physicians* 111 (6), 563-572.

Bonatti, H., Mendez, J., Guerrero, I., Krishna, M., Ananda-Michel, J., Yao, J., Steers, J.L., Hellinger, W., Dickson, R.C., Alvarez, S., 2006. Disseminated *Bartonella* infection following liver transplantation. *Transpl. Int.* 19 (8), 683-687.

Boulouis, H.J., Chang, C.C., Henn, J.B., Kasten, R.W., Chomel, B.B., 2005. Factors associated with the rapid emergence of zoonotic *Bartonella* infections. *Vet. Res.* 36 (3), 383-410.

Breitschwerdt, E.B., Atkins, C.E., Brown, T.T., Kordick, D.L., Snyder, P.S., 1999. *Bartonella vinsonii* subsp. *berkhoffii* and related members of the alpha subdivision of the *Proteobacteria* in dogs with cardiac arrhythmias, endocarditis, or myocarditis. *J. Clin. Microbiol.* 37 (11), 3618-3626.

Breitschwerdt, E.B., Blann, K.R., Stebbins, M.E., Munana, K.R., Davidson, M.G., Jackson, H.A., Willard, M.D., 2004. Clinicopathological abnormalities and treatment response in 24 dogs seroreactive to *Bartonella vinsonii* (*berkhoffii*) antigens. *J. Am. Anim. Hosp. Assoc.* 40 (2), 92-101.

- Breitschwerdt, E.B., Hegarty, B.C., Hancock, S.I., 1998. Sequential evaluation of dogs naturally infected with *Ehrlichia canis*, *Ehrlichia chaffeensis*, *Ehrlichia equi*, *Ehrlichia ewingii*, or *Bartonella vinsonii*. J. Clin. Microbiol. 36 (9), 2645-2651.
- Breitschwerdt, E.B., Hegarty, B.C., Maggi, R., Hawkins, E., Dyer, P., 2005. *Bartonella* species as a potential cause of epistaxis in dogs. J. Clin. Microbiol. 43 (5), 2529-2533.
- Breitschwerdt, E.B., Kordick, D.L., 2000. *Bartonella* infection in animals: Carriership, reservoir potential, pathogenicity, and zoonotic potential for human infection. Clin. Microbiol. Rev. 13 (3), 428-438.
- Breitschwerdt, E.B., Kordick, D.L., Malarkey, D.E., Keene, B., Hadfield, T.L., Wilson, K., 1995. Endocarditis in a dog due to infection with a novel *Bartonella* subspecies. J. Clin. Microbiol. 33 (1), 154-160.
- Breitschwerdt, E.B., Maggi, R.G., Sigmon, B., Nicholson, W.L., 2007. Isolation of *Bartonella quintana* from a woman and a cat following putative bite transmission. J. Clin. Microbiol. 45 (1), 270-272.
- Breitschwerdt, E.B., Sontakke, S., Cannedy, A., Hancock, S.I., Bradley, J.M., 2001. Infection with *Bartonella weissii* and detection of nanobacterium antigens in a North Carolina beef herd. J. Clin. Microbiol. 39 (3), 879-882.
- Brenner, D.J., Hollis, D.G., Moss, C.W., English, C.K., Hall, G.S., Vincent, J., Radosevic, J., Birkness, K.A., Bibb, W.F., Quinn, F.D., 1991. Proposal of *Afipia* gen. nov., with *Afipia felis* sp. nov. (formerly the cat scratch disease bacillus), *Afipia clevelandensis* sp. nov. (formerly the Cleveland clinic foundation strain), *Afipia broomeae* sp. nov., and three unnamed genospecies. J. Clin. Microbiol. 29 (11), 2450-2460.
- Brenner, D.J., O'Connor, S.P., Winkler, H.H., Steigerwalt, A.G., 1993. Proposals to unify the genera *Bartonella* and *Rochalimaea*, with descriptions of *Bartonella quintana* comb. nov., *Bartonella vinsonii* comb. nov., *Bartonella henselae* comb. nov., and *Bartonella elizabethae* comb. nov., and to remove the family Bartonellaceae from the order Rickettsiales. Int. J. Syst. Bacteriol. 43 (4), 777-786.
- Brenner, S.A., Rooney, J.A., Manzewitsch, P., Regnery, R.L., 1997. Isolation of *Bartonella (Rochalimaea) henselae*: Effects of methods of blood collection and handling. J. Clin. Microbiol. 35 (3), 544-547.
- Brouqui, P., La Scola, B., Roux, V., Raoult, D., 1999. Chronic *Bartonella quintana* bacteremia in homeless patients. N. Engl. J. Med. 340 (3), 184-189.
- Brouqui, P., Raoult, D., 2006. Arthropod-borne diseases in homeless. Ann. N. Y. Acad. Sci. 1078, 223-235.

Bruce, D., 1921. Trench fever: Final report of the War Office Trench Fever Investigation Committee. *J. Hyg.* 20, 258-288.

Carmeliet, P., Jain, R.K., 2000. Angiogenesis in cancer and other diseases. *Nature* 407 (6801), 249-257.

Cascales, E., Christie, P.J., 2003. The versatile bacterial type IV secretion systems. *Nat. Rev. Microbiol.* 1 (2), 137-149.

Caygill, C.P., Braddick, M., Hill, M.J., Knowles, R.L., Sharp, J.C., 1995. The association between typhoid carriage, typhoid infection and subsequent cancer at a number of sites. *Eur. J. Cancer Prev.* 4 (2), 187-193.

Centers for Disease Control and Prevention (CDC), 2002. Cat-scratch disease in children--Texas, September 2000-August 2001. *MMWR Morb. Mortal. Wkly. Rep.* 51 (10), 212-214.

CDC, 1993. 1993 revised classification system for HIV infection and expanded surveillance case definition for AIDS among adolescents and adults. *JAMA* 269 (6), 729-730.

Chamberlin, J., Laughlin, L.W., Romero, S., Solorzano, N., Gordon, S., Andre, R.G., Pachas, P., Friedman, H., Ponce, C., Watts, D., 2002. Epidemiology of endemic *Bartonella bacilliformis*: A prospective cohort study in a Peruvian mountain valley community. *J. Infect. Dis.* 186 (7), 983-990.

Chang, C., Yamamoto, K., Chomel, B.B., Kasten, R.W., Simpson, D.C., Smith, C.R., Kramer, V.L., 1999. Seroepidemiology of *Bartonella vinsonii* subsp. *berkhoffii* infection in California coyotes, 1994-1998. *Emerg. Infect. Dis.* 5 (5), 711-715.

Chang, C.C., Chomel, B.B., Kasten, R.W., Heller, R.M., Ueno, H., Yamamoto, K., Bleich, V.C., Pierce, B.M., Gonzales, B.J., Swift, P.K., Boyce, W.M., Jang, S.S., Boulouis, H.J., Piemont, Y., Rossolini, G.M., Riccio, M.L., Cornaglia, G., Pagani, L., Lagatolla, C., Selan, L., Fontana, R., 2000. *Bartonella* spp. isolated from wild and domestic ruminants in North America. *Emerg. Infect. Dis.* 6 (3), 306-311.

Chang, C.C., Chomel, B.B., Kasten, R.W., Romano, V., Tietze, N., 2001. Molecular evidence of *Bartonella* spp. in questing adult *Ixodes pacificus* ticks in California. *J. Clin. Microbiol.* 39 (4), 1221-1226.

Chang, C.C., Kasten, R.W., Chomel, B.B., Simpson, D.C., Hew, C.M., Kordick, D.L., Heller, R., Piemont, Y., Breitschwerdt, E.B., 2000. Coyotes (*Canis latrans*) as the reservoir for a human pathogenic *Bartonella* sp.: Molecular epidemiology of *Bartonella vinsonii*

subsp. *berkhoffii* infection in coyotes from central coastal California. J. Clin. Microbiol. 38 (11), 4193-4200.

Chen, L., Chen, Y., Wood, D.W., Nester, E.W., 2002. A new type IV secretion system promotes conjugal transfer in *Agrobacterium tumefaciens*. J. Bacteriol. 184 (17), 4838-4845.

Chen, L.T., Lin, J.T., Tai, J.J., Chen, G.H., Yeh, H.Z., Yang, S.S., Wang, H.P., Kuo, S.H., Sheu, B.S., Jan, C.M., Wang, W.M., Wang, T.E., Wu, C.W., Chen, C.L., Su, I.J., Whang-Peng, J., Cheng, A.L., 2005. Long-term results of anti-*Helicobacter pylori* therapy in early-stage gastric high-grade transformed MALT lymphoma. J. Natl. Cancer Inst. 97 (18), 1345-1353.

Chenoweth, M.R., Somerville, G.A., Krause, D.C., O'Reilly, K.L., Gherardini, F.C., 2004. Growth characteristics of *Bartonella henselae* in a novel liquid medium: Primary isolation, growth-phase-dependent phage induction, and metabolic studies. Appl. Environ. Microbiol. 70 (2), 656-663.

Chess, Q., Santarsieri, V., Kostroff, K., Phillips, G., 1990. Aspiration cytology of cat scratch disease of the breast. Acta Cytol. 34 (5), 761-762.

Cho, H., Winans, S.C., 2005. VirA and VirG activate the *ti* plasmid *repABC* operon, elevating plasmid copy number in response to wound-released chemical signals. Proc. Natl. Acad. Sci. U. S. A. 102 (41), 14843-14848.

Chomel, B.B., Abbott, R.C., Kasten, R.W., Floyd-Hawkins, K.A., Kass, P.H., Glaser, C.A., Pedersen, N.C., Koehler, J.E., 1995. *Bartonella henselae* prevalence in domestic cats in California: Risk factors and association between bacteremia and antibody titers. J. Clin. Microbiol. 33 (9), 2445-2450.

Chomel, B.B., Boulouis, H.J., Breitschwerdt, E.B., 2004. Cat scratch disease and other zoonotic *Bartonella* infections. J. Am. Vet. Med. Assoc. 224 (8), 1270-1279.

Chomel, B.B., Boulouis, H.J., Maruyama, S., Breitschwerdt, E.B., 2006. *Bartonella* spp. in pets and effect on human health. Emerg. Infect. Dis. 12 (3), 389-394.

Chomel, B.B., Kasten, R.W., Floyd-Hawkins, K., Chi, B., Yamamoto, K., Roberts-Wilson, J., Gurfield, A.N., Abbott, R.C., Pedersen, N.C., Koehler, J.E., 1996. Experimental transmission of *Bartonella henselae* by the cat flea. J. Clin. Microbiol. 34 (8), 1952-1956.

Chomel, B.B., Kasten, R.W., Sykes, J.E., Boulouis, H.J., Breitschwerdt, E.B., 2003. Clinical impact of persistent *Bartonella* bacteremia in humans and animals. Ann. N. Y. Acad. Sci. 990, 267-278.

Chomel, B.B., MacDonald, K.A., Kasten, R.W., Chang, C.C., Wey, A.C., Foley, J.E., Thomas, W.P., Kittleson, M.D., 2001. Aortic valve endocarditis in a dog due to *Bartonella clarridgeiae*. J. Clin. Microbiol. 39 (10), 3548-3554.

Chomel, B.B., Wey, A.C., Kasten, R.W., 2003. Isolation of *Bartonella washoensis* from a dog with mitral valve endocarditis. J. Clin. Microbiol. 41 (11), 5327-5332.

Chumakov, M.I., Kurbanova, I.V., Solovova, G.K., 2002. Agrobacterial transformation of uninjured plants. Russ. J. Plant. Physiol. 49 (6), 799-803.

Chung, C.Y., Kasten, R.W., Paff, S.M., Van Horn, B.A., Vayssier-Taussat, M., Boulouis, H.J., Chomel, B.B., 2004. *Bartonella* spp. DNA associated with biting flies from California. Emerg. Infect. Dis. 10 (7), 1311-1313.

Clarridge, J.E., 3rd, Raich, T.J., Pirwani, D., Simon, B., Tsai, L., Rodriguez-Barradas, M.C., Regnery, R., Zollo, A., Jones, D.C., Rambo, C., 1995. Strategy to detect and identify *Bartonella* species in routine clinical laboratory yields *Bartonella henselae* from human immunodeficiency virus-positive patient and unique *Bartonella* strain from his cat. J. Clin. Microbiol. 33 (8), 2107-2113.

Cleaveland, S., Laurenson, M.K., Taylor, L.H., 2001. Diseases of humans and their domestic mammals: Pathogen characteristics, host range, and the risk of emergence. Philos. Trans. R. Soc. Lond. B. Biol. Sci. 356 (1411), 991-999.

Cockerell, C.J., Bergstresser, P.R., Myrie-Williams, C., Tierno, P.M., 1990. Bacillary epithelioid angiomatosis occurring in an immunocompetent individual. Arch. Dermatol. 126 (6), 787-790.

Comer, J.A., Diaz, T., Vlahov, D., Monterroso, E., Childs, J.E., 2001. Evidence of rodent-associated *Bartonella* and *Rickettsia* infections among intravenous drug users from central and east Harlem, New York City. Am. J. Trop. Med. Hyg. 65 (6), 855-860.

Comer, J.A., Flynn, C., Regnery, R.L., Vlahov, D., Childs, J.E., 1996. Antibodies to *Bartonella* species in inner-city intravenous drug users in Baltimore, MD. Arch. Intern. Med. 156 (21), 2491-2495.

Conley, T., Slater, L., Hamilton, K., 1994. *Rochalimaea* species stimulate human endothelial cell proliferation and migration *in vitro*. J. Lab. Clin. Med. 124 (4), 521-528.

Cunningham, E.T., Koehler, J.E., 2000. Ocular bartonellosis. Am. J. Ophthalmol. 130 (3), 340-349.

Daly, J.S., Worthington, M.G., Brenner, D.J., Moss, C.W., Hollis, D.G., Weyant, R.S., Steigerwalt, A.G., Weaver, R.E., Daneshvar, M.I., O'Connor, S.P., 1993. *Rochalimaea*

elizabethae sp. nov. isolated from a patient with endocarditis. J. Clin. Microbiol. 31 (4), 872-881.

Dangman, B.C., Albanese, B.A., Kacica, M.A., Lepow, M.L., Wallach, M.T., 1995. Cat scratch disease in two children presenting with fever of unknown origin: Imaging features and association with a new causative agent, *Rochalimaea henselae*. Pediatrics 95 (5), 767-771.

Dawson, P.M., Shousha, S., Burn, J.I., 1987. Lymph nodes presenting as breast lumps. Br. J. Surg. 74 (12), 1167-1168.

Daybell, D., Paddock, C.D., Zaki, S.R., Comer, J.A., Woodruff, D., Hansen, K.J., Peacock, J.E., Jr., 2004. Disseminated infection with *Bartonella henselae* as a cause of spontaneous splenic rupture. Clin. Infect. Dis. 39 (3), 21-24.

De Sousa, R., Edouard-Fournier, P., Santos-Silva, M., Amaro, F., Bacellar, F., Raoult, D., 2006. Molecular detection of *Rickettsia felis*, *Rickettsia typhi* and two genotypes closely related to *Bartonella elizabethae*. Am. J. Trop. Med. Hyg. 75 (4), 727-731.

Debré, R., Lamy, M., Jammet, M.L., Costil, L., Mozziconacci, P., 1950. La maladie des griffes de chat. Bull. Membres Soc. Méd. Hôp. Paris 66, 76-79.

Dehio, C., 2004. Molecular and cellular basis of *Bartonella* pathogenesis. Annu. Rev. Microbiol. 58, 365-390.

Dehio, C., 2003. Recent progress in understanding *Bartonella*-induced vascular proliferation. Curr. Opin. Microbiol. 6 (1), 61-65.

Dehio, C., 2001. *Bartonella* interactions with endothelial cells and erythrocytes. Trends Microbiol. 9 (6), 279-285.

Dehio, C., Sauder, U., Hiestand, R., 2004. Isolation of *Bartonella schoenbuchensis* from *Lipoptena cervi*, a blood-sucking arthropod causing deer ked dermatitis. J. Clin. Microbiol. 42 (11), 5320-5323.

Demers, D.M., Bass, J.W., Vincent, J.M., Person, D.A., Noyes, D.K., Staeger, C.M., Samlaska, C.P., Lockwood, N.H., Regnery, R.L., Anderson, B.E., 1995. Cat-scratch disease in Hawaii: Etiology and seroepidemiology. J. Pediatr. 127 (1), 23-26.

Deregibus, M.C., Cantaluppi, V., Doublier, S., Brizzi, M.F., Deambrosis, I., Albini, A., Camussi, G., 2002. HIV-1-tat protein activates phosphatidylinositol 3-kinase/AKT-dependent survival pathways in Kaposi's sarcoma cells. J. Biol. Chem. 277 (28), 25195-25202.

Dolan, M.J., Wong, M.T., Regnery, R.L., Jorgensen, J.H., Garcia, M., Peters, J., Drehner, D., 1993. Syndrome of *Rochalimaea henselae* adenitis suggesting cat scratch disease. *Ann. Intern. Med.* 118 (5), 331-336.

Donato, F., Boffetta, P., Puoti, M., 1998. A meta-analysis of epidemiological studies on the combined effect of hepatitis B and C virus infections in causing hepatocellular carcinoma. *Int. J. Cancer* 75 (3), 347-354.

Dondey, J.C., Sullivan, T.J., Robson, J.M., Gatto, J., 1997. Application of polymerase chain reaction assay in the diagnosis of orbital granuloma complicating atypical oculoglandular cat scratch disease. *Ophthalmology* 104 (7), 1174-1178.

Dooley, J.R., 1980. Haemotropic bacteria in man. *Lancet* 2 (8206), 1237-1239.

Drancourt, M., Bodaghi, B., Lepidi, H., Le Hoang, P., Raoult, D., 2004. Intraocular detection of *Bartonella henselae* in a patient with HLA-B27 uveitis. *J. Clin. Microbiol.* 42 (4), 1822-1825.

Drancourt, M., Mainardi, J.L., Brouqui, P., Vandenesch, F., Carta, A., Lehnert, F., Etienne, J., Goldstein, F., Acar, J., Raoult, D., 1995. *Bartonella (Rochalimaea) quintana* endocarditis in three homeless men. *N. Engl. J. Med.* 332 (7), 419-423.

Drancourt, M., Moal, V., Brunet, P., Dussol, B., Berland, Y., Raoult, D., 1996. *Bartonella (Rochalimaea) quintana* infection in a seronegative hemodialyzed patient. *J. Clin. Microbiol.* 34 (5), 1158-1160.

Droz, S., Chi, B., Horn, E., Steigerwalt, A.G., Whitney, A.M., Brenner, D.J., 1999. *Bartonella koehlerae* sp. nov., isolated from cats. *J. Clin. Microbiol.* 37 (4), 1117-1122.

Duncan, A.W., Correa, M.T., Levine, J.F., Breitschwerdt, E.B., 2004. The dog as a sentinel for human infection: Prevalence of *Borrelia burgdorferi* C6 antibodies in dogs from southeastern and mid-Atlantic states. *Vector Borne Zoonotic Dis.* 4 (3), 221-229.

Duncan, A.W., Maggi, R.G., Breitschwerdt, E.B., 2007. A combined approach for the enhanced detection and isolation of *Bartonella* species in dog blood samples: Pre-enrichment liquid culture followed by PCR and subculture onto agar plates. *J Microbiol Methods.* 69 (2), 273-281.

Edlich, R.F., Arnette, J.A., Williams, F.M., 2000. Global epidemic of human T-cell lymphotropic virus type-1 (HTLV-1). *J. Emerg. Med.* 18 (1), 109-119.

Ellis, B.A., Regnery, R.L., Beati, L., Bacellar, F., Rood, M., Glass, G.G., Marston, E., Ksiazek, T.G., Jones, D., Childs, J.E., 1999a. Rats of the genus *Rattus* are reservoir hosts for pathogenic *Bartonella* species: An old world origin for a new world disease? *J. Infect. Dis.* 180 (1), 220-224.

Ellis, B.A., Rotz, L.D., Leake, J.A., Samalvides, F., Bernable, J., Ventura, G., Padilla, C., Villaseca, P., Beati, L., Regnery, R., Childs, J.E., Olson, J.G., Carrillo, C.P., 1999b. An outbreak of acute bartonellosis (Oroya fever) in the Urubamba region of Peru, 1998. *Am. J. Trop. Med. Hyg.* 61 (2), 344-349.

Eng, T.R., Wilson, M.L., Spielman, A., Lastavica, C.C., 1988. Greater risk of *Borrelia burgdorferi* infection in dogs than in people. *J. Infect. Dis.* 158 (6), 1410-1411.

English, C.K., Wear, D.J., Margileth, A.M., Lissner, C.R., Walsh, G.P., 1988. Cat-scratch disease: Isolation and culture of the bacterial agent. *JAMA* 259 (9), 1347-1352.

Ensoli, B., Sturzl, M., 1998. Kaposi's sarcoma: A result of the interplay among inflammatory cytokines, angiogenic factors and viral agents. *Cytokine Growth Factor Rev.* 9 (1), 63-83.

Eskow, E., Rao, R.V., Mordechai, E., 2001. Concurrent infection of the central nervous system by *Borrelia burgdorferi* and *Bartonella henselae*: Evidence for a novel tick-borne disease complex. *Arch. Neurol.* 58 (9), 1357-1363.

Estrella, M., Cosgrove, S.E., 2002. Cases from the Osler Medical Service at Johns Hopkins University. *Bartonella henselae* infection of the liver and spleen. *Am. J. Med.* 113 (4), 344-346.

Fenollar, F., Sire, S., Raoult, D., 2005. *Bartonella vinsonii* subsp. *arupensis* as an agent of blood culture-negative endocarditis in a human. *J. Clin. Microbiol.* 43 (2), 945-947.

Ferrara, N., Gerber, H.P., 2001. The role of vascular endothelial growth factor in angiogenesis. *Acta Haematol.* 106 (4), 148-156.

Ferreri, A.J., Guidoboni, M., Ponzoni, M., De Conciliis, C., Dell'Oro, S., Fleischhauer, K., Caggiari, L., Lettini, A.A., Dal Cin, E., Ieri, R., Freschi, M., Villa, E., Boiocchi, M., Dolcetti, R., 2004. Evidence for an association between *Chlamydia psittaci* and ocular adnexal lymphomas. *J. Natl. Cancer Inst.* 96 (8), 586-594.

Finkelstein, J.L., Brown, T.P., O'Reilly, K.L., Wedincamp, J., Jr, Foil, L.D., 2002. Studies on the growth of *Bartonella henselae* in the cat flea (Siphonaptera: Pulicidae). *J. Med. Entomol.* 39 (6), 915-919.

Foil, L., Andress, E., Freeland, R.L., Roy, A.F., Rutledge, R., Triche, P.C., O'Reilly, K.L., 1998. Experimental infection of domestic cats with *Bartonella henselae* by inoculation of *Ctenocephalides felis* (Siphonaptera: Pulicidae) feces. *J. Med. Entomol.* 35 (5), 625-628.

Fortune, S.M., Kaelin, C.M., Gulizia, J.M., Daily, J.P., 2000. Cat scratch disease presenting as a breast mass. *Obstet. Gynecol.* 95 (6 - Pt 2), 1027.

- Foucault, C., Barrau, K., Brouqui, P., Raoult, D., 2002. *Bartonella quintana* bacteremia among homeless people. Clin. Infect. Dis. 35 (6), 684-689.
- Foucault, C., Brouqui, P., Raoult, D., 2006. *Bartonella quintana* characteristics and clinical management. Emerg. Infect. Dis. 12 (2), 217-223.
- Foucault, C., Rolain, J.M., Raoult, D., Brouqui, P., 2004. Detection of *Bartonella quintana* by direct immunofluorescence examination of blood smears of a patient with acute trench fever. J. Clin. Microbiol. 42 (10), 4904-4906.
- Fournier, P.E., Lelievre, H., Eykyn, S.J., Mainardi, J.L., Marrie, T.J., Bruneel, F., Roure, C., Nash, J., Clave, D., James, E., Benoit-Lemercier, C., Deforges, L., Tissot-Dupont, H., Raoult, D., 2001. Epidemiologic and clinical characteristics of *Bartonella quintana* and *Bartonella henselae* endocarditis: A study of 48 patients. Medicine (Baltimore) 80 (4), 245-251.
- Fournier, P.E., Mainardi, J.L., Raoult, D., 2002a. Value of microimmunofluorescence for diagnosis and follow-up of *Bartonella* endocarditis. Clin. Diagn. Lab. Immunol. 9 (4), 795-801.
- Fournier, P.E., Ndiokubwayo, J.B., Guidran, J., Kelly, P.J., Raoult, D., 2002b. Human pathogens in body and head lice. Emerg. Infect. Dis. 8 (12), 1515-1518.
- Fournier, P.E., Robson, J., Zeaiter, Z., McDougall, R., Byrne, S., Raoult, D., 2002c. Improved culture from lymph nodes of patients with cat scratch disease and genotypic characterization of *Bartonella henselae* isolates in Australia. J. Clin. Microbiol. 40 (10), 3620-3624.
- Franceschi, S., Dal Maso, L., La Vecchia, C., 1999. Advances in the epidemiology of HIV-associated non-Hodgkin's lymphoma and other lymphoid neoplasms. Int. J. Cancer 83 (4), 481-485.
- Franchini, G., Fukumoto, R., Fullen, J.R., 2003. T-cell control by human T-cell leukemia/lymphoma virus type 1. Int. J. Hematol. 78 (4), 280-296.
- Gallo, R.C., 1999. Tat as one key to HIV-induced immune pathogenesis and tat (correction of pat) toxoid as an important component of a vaccine. Proc. Natl. Acad. Sci. U. S. A. 96 (15), 8324-8326.
- Gallo, R.C., 1998. Some aspects of the pathogenesis of HIV-1-associated Kaposi's sarcoma. J. Natl. Cancer. Inst. Monogr. 23, 55-57.
- Garcia, F.U., Wojta, J., Broadley, K.N., Davidson, J.M., Hoover, R.L., 1990. *Bartonella bacilliformis* stimulates endothelial cells *in vitro* and is angiogenic *in vivo*. Am. J. Pathol. 136 (5), 1125-1135.

García-Esteban, C., Escudero, R., Barandika, J.F., Chaparro, E., Rodríguez-Moreno, I., García-Pérez, A., Oteo, J.A., Blanco, J.R., Eiros, J.M., Anda, P., 2005. A molecular method for the identification of *bartonella* species in clinical and environmental samples. 4th International Conference on Rickettsiae, Logroño, Spain. Poster 151.

Gates, A.E., Kaplan, L.D., 2003. Biology and management of AIDS-associated non-Hodgkin's lymphoma. *Hematol. Oncol. Clin. North Am.* 17 (3), 821-841.

Gatza, M.L., Chandhasin, C., Ducu, R.I., Marriott, S.J., 2005. Impact of transforming viruses on cellular mutagenesis, genome stability, and cellular transformation. *Environ. Mol. Mutagen.* 45 (2-3), 304-325.

George, J.G., Bradley, J.C., Kimbrough, R.C., 3rd, Shami, M.J., 2006. *Bartonella quintana* associated neuroretinitis. *Scand. J. Infect. Dis.* 38 (2), 127-128.

Gerber, J.E., Johnson, J.E., Scott, M.A., Madhusudhan, K.T., 2002. Fatal meningitis and encephalitis due to *Bartonella henselae* bacteria. *J. Forensic Sci.* 47 (3), 640-644.

Ghez, D., Bernard, L., Bayou, E., Bani-Sadr, F., Vallee, C., Perronne, C., 2001. *Bartonella henselae* infection mimicking a splenic lymphoma. *Scand. J. Infect. Dis.* 33 (12), 935-936.

Giladi, M., Maman, E., Paran, D., Bickels, J., Comaneshter, D., Avidor, B., Varon-Graidy, M., Ephros, M., Wientroub, S., 2005. Cat-scratch disease-associated arthropathy. *Arthritis Rheum.* 52 (11), 3611-3617.

Gillespie, T.N., Washabau, R.J., Goldschmidt, M.H., Cullen, J.M., Rogala, A.R., Breitschwerdt, E.B., 2003. Detection of *Bartonella henselae* and *Bartonella clarridgeiae* DNA in hepatic specimens from two dogs with hepatic disease. *J. Am. Vet. Med. Assoc.* 222 (1), 47-51, 35.

Godet, C., Roblot, F., Le Moal, G., Roblot, P., Frat, J.P., Becq-Giraudon, B., 2004. Cat-scratch disease presenting as a breast mass. *Scand. J. Infect. Dis.* 36 (6-7), 494-495.

Goff, S.P., 2001. *Retroviridae: The retroviruses and their replication*. In: *Fields Virology*. 4th edition. (Lippincott, Williams & Wilkins), 1871-1939.

Goodman, R.A., Breitschwerdt, E.B., 2005. Clinicopathologic findings in dogs seroreactive to *Bartonella henselae* antigens. *Am. J. Vet. Res.* 66 (12), 2060-2064.

Gouriet, F., Fenollar, F., Patrice, J.Y., Drancourt, M., Raoult, D., 2005. Use of shell-vial cell culture assay for isolation of bacteria from clinical specimens: 13 years of experience. *J. Clin. Microbiol.* 43 (10), 4993-5002.

Greub, G., Raoult, D., 2002. *Bartonella*: New explanations for old diseases. *J. Med. Microbiol.* 51 (11), 915-923.

- Grulich, A.E., Wan, X., Law, M.G., Coates, M., Kaldor, J.M., 1999. Risk of cancer in people with AIDS. *AIDS* 13 (7), 839-843.
- Guerra, M.A., Walker, E.D., Kitron, U., 2001. Canine surveillance system for Lyme borreliosis in Wisconsin and northern Illinois: Geographic distribution and risk factor analysis. *Am. J. Trop. Med. Hyg.* 65 (5), 546-552.
- Gundi, V.A., Bourry, O., Davous, B., Raoult, D., La Scola, B., 2004. *Bartonella clarridgeiae* and *B. henselae* in dogs, Gabon. *Emerg. Infect. Dis.* 10 (12), 2261-2262.
- Hadfield, T.L., Warren, R., Kass, M., Brun, E., Levy, C., 1993. Endocarditis caused by *Rochalimaea henselae*. *Hum. Pathol.* 24 (10), 1140-1141.
- Halos, L., Jamal, T., Maillard, R., Girard, B., Guillot, J., Chomel, B., Vayssier-Taussat, M., Boulouis, H.J., 2004. Role of *Hippoboscidae* flies as potential vectors of *Bartonella* spp. infecting wild and domestic ruminants. *Appl. Environ. Microbiol.* 70 (10), 6302-6305.
- Hanahan, D., Weinberg, R.A., 2000. The hallmarks of cancer. *Cell* 100 (1), 57-70.
- Hansmann, Y., DeMartino, S., Piemont, Y., Meyer, N., Mariet, P., Heller, R., Christmann, D., Jaulhac, B., 2005. Diagnosis of cat scratch disease with detection of *Bartonella henselae* by PCR: A study of patients with lymph node enlargement. *J. Clin. Microbiol.* 43 (8), 3800-3806.
- Heller, R., Kubina, M., Mariet, P., Riegel, P., Delacour, G., Dehio, C., Lamarque, F., Kasten, R., Boulouis, H.J., Monteil, H., Chomel, B., Piemont, Y., 1999. *Bartonella alsatica* sp. nov., a new *Bartonella* species isolated from the blood of wild rabbits. *Int. J. Syst. Bacteriol.* 49 (Pt 1), 283-288.
- Heller, R., Riegel, P., Hansmann, Y., Delacour, G., Bermond, D., Dehio, C., Lamarque, F., Monteil, H., Chomel, B., Piemont, Y., 1998. *Bartonella tribocorum* sp. nov., a new *Bartonella* species isolated from the blood of wild rats. *Int. J. Syst. Bacteriol.* 48 (Pt 4), 1333-1339.
- Henn, J.B., Liu, C.H., Kasten, R.W., VanHorn, B.A., Beckett, L.A., Kass, P.H., Chomel, B.B., 2005. Seroprevalence of antibodies against *Bartonella* species and evaluation of risk factors and clinical signs associated with seropositivity in dogs. *Am. J. Vet. Res.* 66 (4), 688-694.
- Henn, J.B., Vanhorn, B.A., Kasten, R.W., Kachani, M., Chomel, B.B., 2006. Antibodies to *Bartonella vinsonii* subsp. *berkhoffii* in Moroccan dogs. *Am. J. Trop. Med. Hyg.* 74 (2), 222-223.

- Higgins, J.A., Radulovic, S., Jaworski, D.C., Azad, A.F., 1996. Acquisition of the cat scratch disease agent *Bartonella henselae* by cat fleas (Siphonaptera: Pulicidae). *J. Med. Entomol.* 33 (3), 490-495.
- Hinrichsen, V.L., Whitworth, U.G., Breitschwerdt, E.B., Hegarty, B.C., Mather, T.N., 2001. Assessing the association between the geographic distribution of deer ticks and seropositivity rates to various tick-transmitted disease organisms in dogs. *J. Am. Vet. Med. Assoc.* 218 (7), 1092-1097.
- Hoar, B.R., Chomel, B.B., Rolfe, D.L., Chang, C.C., Fritz, C.L., Sacks, B.N., Carpenter, T.E., 2003. Spatial analysis of *Yersinia pestis* and *Bartonella vinsonii* subsp. *berkhoffii* seroprevalence in California coyotes (*Canis latrans*). *Prev. Vet. Med.* 56 (4), 299-311.
- Holden, K., Boothby, J.T., Kasten, R.W., Chomel, B.B., 2006. Co-detection of *Bartonella henselae*, *Borrelia burgdorferi*, and *Anaplasma phagocytophilum* in *Ixodes pacificus* ticks from California, USA. *Vector Borne Zoonotic Dis.* 6 (1), 99-102.
- Holmberg, M., McGill, S., Ehrenborg, C., Wesslen, L., Hjelm, E., Darelid, J., Blad, L., Engstrand, L., Regnery, R., Friman, G., 1999. Evaluation of human seroreactivity to *Bartonella* species in Sweden. *J. Clin. Microbiol.* 37 (5), 1381-1384.
- Holmes, A.H., Greenough, T.C., Balady, G.J., Regnery, R.L., Anderson, B.E., O'Keane, J.C., Fonger, J.D., McCrone, E.L., 1995. *Bartonella henselae* endocarditis in an immunocompetent adult. *Clin. Infect. Dis.* 21 (4), 1004-1007.
- Honadel, T.E., Chomel, B.B., Yamamoto, K., Chang, C., Farver, T.B., 2001. Seroepidemiology of *Bartonella vinsonii* subsp. *berkhoffii* exposure among healthy dogs. *J. Am. Vet. Med. Assoc.* 219 (4), 480-484.
- Hooykaas, P.J.J., Beijersbergen, A.G.M., 1994. The virulence system of *Agrobacterium tumefaciens*. *Annu. Rev. Phytopathol.* 32, 157-79.
- Houpikian, P., Raoult, D., 2005. Blood culture-negative endocarditis in a reference center: Etiologic diagnosis of 348 cases. *Medicine (Baltimore)* 84 (3), 162-173.
- Hsu, J.L., Glaser, S.L., 2000. Epstein-Barr virus-associated malignancies: Epidemiologic patterns and etiologic implications. *Crit. Rev. Oncol. Hematol.* 34 (1), 27-53.
- Humar, A., Salit, I., 1999. Disseminated *Bartonella* infection with granulomatous hepatitis in a liver transplant recipient. *Liver Transpl. Surg.* 5 (3), 249-251.
- Ihler, G.M., 1996. *Bartonella bacilliformis*: Dangerous pathogen slowly emerging from deep background. *FEMS Microbiol. Lett.* 144 (1), 1-11.

International Collaboration on HIV and Cancer, 2000. Highly active antiretroviral therapy and incidence of cancer in human immunodeficiency virus-infected adults. *J. Natl. Cancer Inst.* 92 (22), 1823-1830.

Iredell, J., Blanckenberg, D., Arvand, M., Grauling, S., Feil, E.J., Birtles, R.J., 2003. Characterization of the natural population of *Bartonella henselae* by multilocus sequence typing. *J. Clin. Microbiol.* 41 (11), 5071-5079.

Isaacson, P., Du, M-G., 2004. MALT lymphoma: From morphology to molecules. *Nature Rev. Cancer* 4, 644-653.

Jackson, L.A., Spach, D.H., 1996a. Emergence of *Bartonella quintana* infection among homeless persons. *Emerg. Infect. Dis.* 2 (2), 141-144.

Jackson, L.A., Spach, D.H., Kippen, D.A., Sugg, N.K., Regnery, R.L., Sayers, M.H., Stamm, W.E., 1996b. Seroprevalence to *Bartonella quintana* among patients at a community clinic in downtown Seattle. *J. Infect. Dis.* 173 (4), 1023-1026.

Jacobs, R.F., Schutze, G.E., 1998. *Bartonella henselae* as a cause of prolonged fever and fever of unknown origin in children. *Clin. Infect. Dis.* 26 (1), 80-84.

Jacobson, L.P., Armenian, H.K., 1995. An integrated approach to the epidemiology of Kaposi's sarcoma. *Curr. Opin. Oncol.* 7 (5), 450-455.

Jacomo, V., Kelly, P.J., Raoult, D., 2002. Natural history of *Bartonella* infections (an exception to Koch's postulate). *Clin. Diagn. Lab. Immunol.* 9 (1), 8-18.

Jameson, P., Greene, C., Regnery, R., Dryden, M., Marks, A., Brown, J., Cooper, J., Glaus, B., Greene, R., 1995. Prevalence of *Bartonella henselae* antibodies in pet cats throughout regions of North America. *J. Infect. Dis.* 172 (4), 1145-1149.

Jarrett, R.F., 2006. Viruses and lymphoma/leukaemia. *J. Pathol.* 208 (2), 176-186.

Jeang, K.T., Giam, C.Z., Majone, F., Aboud, M., 2004. Life, death, and tax: Role of HTLV-1 oncoprotein in genetic instability and cellular transformation. *J. Biol. Chem.* 279 (31), 31991-31994.

Johnson, G., Ayers, M., McClure, S.C., Richardson, S.E., Tellier, R., 2003. Detection and identification of *Bartonella* species pathogenic for humans by PCR amplification targeting the riboflavin synthase gene (*ribC*). *J. Clin. Microbiol.* 41 (3), 1069-1072.

Jüttner, S., Cramer, T., Wessler, S., Walduck, A., Gao, F., Schmitz, F., Wunder, C., Weber, M., Fischer, S.M., Schmidt, W.E., Wiedenmann, B., Meyer, T.F., Naumann, M., Hocker, M., 2003. *Helicobacter pylori* stimulates host cyclooxygenase-2 gene

transcription: Critical importance of MEK/ERK-dependent activation of USF1/-2 and CREB transcription factors. *Cell. Microbiol.* 5 (11), 821-834.

Kahn, L.H., 2006. Confronting zoonoses, linking human and veterinary medicine. *Emerg. Infect. Dis.* 12 (4), 556-561.

Karakas, M., Baba, M., Aksungur, V.L., Homan, S., Memisoglu, H.R., Uguz, A., 2000. Bacillary angiomatosis on a region of burned skin in a immunocompetent patient. *Br. J. Dermatol.* 143 (3), 609-611.

Karem, K.L., Paddock, C.D., Regnery, R.L., 2000. *Bartonella henselae*, *B. quintana*, and *B. bacilliformis*: Historical pathogens of emerging significance. *Microbes Infect.* 2 (10), 1193-1205.

Kawakami, H., Tomita, M., Matsuda, T., Ohta, T., Tanaka, Y., Fujii, M., Hatano, M., Tokuhisa, T., Mori, N., 2005. Transcriptional activation of survivin through the NF-kappa-B pathway by human T-cell leukemia virus type 1 tax. *Int. J. Cancer* 115 (6), 967-974.

Kelly, P., Rolain, J.M., Maggi, R., Sontakke, S., Keene, B., Hunter, S., Leipidi, H., Breitschwerdt, K.T., Breitschwerdt, E.B., Raoult, D., 2006. *Bartonella quintana* endocarditis in dogs. *Emerg. Infect. Dis.* 12, 1896-1872.

Kelly, P.J., Eoghain, G.N., Raoult, D., 2004. Antibodies reactive with *Bartonella henselae* and *Ehrlichia canis* in dogs from the communal lands of Zimbabwe. *J. S. Afr. Vet. Assoc.* 75 (3), 116-120.

Kempf, V.A., Hitziger, N., Riess, T., Autenrieth, I.B., 2002. Do plant and human pathogens have a common pathogenicity strategy? *Trends Microbiol.* 10 (6), 269-275.

Kempf, V.A., Volkmann, B., Schaller, M., Sander, C.A., Alitalo, K., Riess, T., Autenrieth, I.B., 2001. Evidence of a leading role for VEGF in *Bartonella henselae*-induced endothelial cell proliferations. *Cell. Microbiol.* 3 (9), 623-632.

Kerkhoff, F.T., Bergmans, A.M., van Der Zee, A., Rothova, A., 1999. Demonstration of *Bartonella grahamii* DNA in ocular fluids of a patient with neuroretinitis. *J. Clin. Microbiol.* 37 (12), 4034-4038.

Khanna, C., Lindblad-Toh, K., Vail, D., London, C., Bergman, P., Barber, L., Breen, M., Kitchell, B., McNeil, E., Modiano, J.F., Niemi, S., Comstock, K.E., Ostrander, E., Westmoreland, S., Withrow, S., 2006. The dog as a cancer model. *Nat. Biotechnol.* 24 (9), 1065-1066.

Kirby, J.E., Nekorchuk, D.M., 2002. *Bartonella*-associated endothelial proliferation depends on inhibition of apoptosis. *Proc. Natl. Acad. Sci. U. S. A.* 99 (7), 4656-4661.

Kirkness, E.F., Bafna, V., Halpern, A.L., Levy, S., Remington, K., Rusch, D.B., Delcher, A.L., Pop, M., Wang, W., Fraser, C.M., Venter, J.C., 2003. The dog genome: Survey sequencing and comparative analysis. *Science* 301 (5641), 1898-1903.

Kitchell, B.E., Fan, T.M., Kordick, D., Breitschwerdt, E.B., Wollenberg, G., Lichtensteiger, C.A., 2000. Peliosis hepatis in a dog infected with *Bartonella henselae*. *J. Am. Vet. Med. Assoc.* 216 (4), 519-23, 517.

Knapp, D.W., Waters, D.J., 1997. Naturally occurring cancer in pet dogs: Important models for developing improved cancer therapy for humans. *Mol. Med. Today* 3 (1), 8-11.

Knobler, E.H., Silvers, D.N., Fine, K.C., Lefkowitz, J.H., Grossman, M.E., 1988. Unique vascular skin lesions associated with human immunodeficiency virus. *JAMA* 260 (4), 524-527.

Koehler, J.E., 1995. *Bartonella*-associated infections in HIV-infected patients. *AIDS Clin. Care* 7 (12), 97-102.

Koehler, J.E., Glaser, C.A., Tappero, J.W., 1994. *Rochalimaea henselae* infection. A new zoonosis with the domestic cat as reservoir. *JAMA* 271 (7), 531-535.

Koehler, J.E., LeBoit, P.E., Egbert, B.M., Berger, T.G., 1988. Cutaneous vascular lesions and disseminated cat-scratch disease in patients with the acquired immunodeficiency syndrome (AIDS) and AIDS-related complex. *Ann. Intern. Med.* 109 (6), 449-455.

Koehler, J.E., Quinn, F.D., Berger, T.G., LeBoit, P.E., Tappero, J.W., 1992. Isolation of *Rochalimaea* species from cutaneous and osseous lesions of bacillary angiomatosis. *N. Engl. J. Med.* 327 (23), 1625-1631.

Koehler, J.E., Sanchez, M.A., Garrido, C.S., Whitfeld, M.J., Chen, F.M., Berger, T.G., Rodriguez-Barradas, M.C., LeBoit, P.E., Tappero, J.W., 1997. Molecular epidemiology of *Bartonella* infections in patients with bacillary angiomatosis-peliosis. *N. Engl. J. Med.* 337 (26), 1876-1883.

Koehler, J.E., Sanchez, M.A., Tye, S., Garrido-Rowland, C.S., Chen, F.M., Maurer, T., Cooper, J.L., Olson, J.G., Reingold, A.L., Hadley, W.K., Regnery, R.R., Tappero, J.W., 2003. Prevalence of *Bartonella* infection among human immunodeficiency virus-infected patients with fever. *Clin. Infect. Dis.* 37 (4), 559-566.

Koehler, J.E., Tappero, J.W., 1993. Bacillary angiomatosis and bacillary peliosis in patients infected with human immunodeficiency virus. *Clin. Infect. Dis.* 17 (4), 612-624.

Konig, J.E., Tolnay, E., Wiethage, T., Muller, K.M., 1999. Expression of vascular endothelial growth factor in diffuse malignant pleural mesothelioma. *Virchows Arch.* 435 (1), 8-12.

Kordick, D.L., Breitschwerdt, E.B., 1998. Persistent infection of pets within a household with three *Bartonella* species. *Emerg. Infect. Dis.* 4 (2), 325-328.

Kordick, D.L., Hilyard, E.J., Hadfield, T.L., Wilson, K.H., Steigerwalt, A.G., Brenner, D.J., Breitschwerdt, E.B., 1997. *Bartonella clarridgeiae*, a newly recognized zoonotic pathogen causing inoculation papules, fever, and lymphadenopathy (cat scratch disease). *J. Clin. Microbiol.* 35 (7), 1813-1818.

Kordick, D.L., Swaminathan, B., Greene, C.E., Wilson, K.H., Whitney, A.M., O'Connor, S., Hollis, D.G., Matar, G.M., Steigerwalt, A.G., Malcolm, G.B., Hayes, P.S., Hadfield, T.L., Breitschwerdt, E.B., Brenner, D.J., 1996. *Bartonella vinsonii* subsp. *berkhoffii* subsp. nov., isolated from dogs; *Bartonella vinsonii* subsp. *vinsonii*; and emended description of *Bartonella vinsonii*. *Int. J. Syst. Bacteriol.* 46 (3), 704-709.

Kordick, D.L., Wilson, K.H., Sexton, D.J., Hadfield, T.L., Berkhoff, H.A., Breitschwerdt, E.B., 1995. Prolonged *Bartonella* bacteremia in cats associated with cat-scratch disease patients. *J. Clin. Microbiol.* 33 (12), 3245-3251.

Kordick, S.K., Breitschwerdt, E.B., Hegarty, B.C., Southwick, K.L., Colitz, C.M., Hancock, S.I., Bradley, J.M., Rumbough, R., McPherson, J.T., MacCormack, J.N., 1999. Coinfection with multiple tick-borne pathogens in a Walker hound kennel in North Carolina. *J. Clin. Microbiol.* 37 (8), 2631-2638.

Kosoy, M., Murray, M., Gilmore, R.D., Jr, Bai, Y., Gage, K.L., 2003. *Bartonella* strains from ground squirrels are identical to *Bartonella washoensis* isolated from a human patient. *J. Clin. Microbiol.* 41 (2), 645-650.

La Scola, B., Raoult, D., 1999. Culture of *Bartonella quintana* and *Bartonella henselae* from human samples: A 5-year experience (1993 to 1998). *J. Clin. Microbiol.* 37 (6), 1899-1905.

La, V.D., Tran-Hung, L., Aboudharam, G., Raoult, D., Drancourt, M., 2005. *Bartonella quintana* in domestic cat. *Emerg. Infect. Dis.* 11 (8), 1287-1289.

Larsson, E., Wesslen, L., Lindquist, O., Baandrup, U., Eriksson, L., Olsen, E., Rolf, C., Friman, G., 1999. Sudden unexpected cardiac deaths among young Swedish orienteers--morphological changes in hearts and other organs. *APMIS* 107 (3), 325-336.

Lawson, P.A., Collins, M.D., 1996. Description of *Bartonella clarridgeiae* sp. nov. isolated from the cat of a patient with *Bartonella henselae* septicemia. *Med. Microbiol. Lett.* 5, 64-73.

Lax, A.J., Thomas, W., 2002. How bacteria could cause cancer: One step at a time. *Trends Microbiol.* 10 (6), 293-299.

LeBoit, P.E., Berger, T.G., Egbert, B.M., Yen, T.S., Stoler, M.H., Bonfiglio, T.A., Strauchen, J.A., English, C.K., Wear, D.J., 1988. Epithelioid haemangioma-like vascular proliferation in AIDS: Manifestation of cat scratch disease bacillus infection? *Lancet* 1 (8592), 960-963.

Lecuit, M., Abachin, E., Martin, A., Poyart, C., Pochart, P., Suarez, F., Bengoufa, D., Feuillard, J., Lavergne, A., Gordon, J.I., Berche, P., Guillemin, L., Lortholary, O., 2004. Immunoproliferative small intestinal disease associated with *Campylobacter jejuni*. *N. Engl. J. Med.* 350 (3), 239-248.

Ledergerber, B., Telenti, A., Egger, M., 1999. Risk of HIV related Kaposi's sarcoma and non-Hodgkin's lymphoma with potent antiretroviral therapy: Prospective cohort study. Swiss HIV cohort study. *BMJ* 319 (7201), 23-24.

Lefkowitz, M., Wear, D.J., 1989. Cat-scratch disease masquerading as a solitary tumor of the breast. *Arch. Pathol. Lab. Med.* 113 (5), 473-475.

Lindblad-Toh, K., Wade, C.M., Mikkelsen, T.S., Karlsson, E.K., Jaffe, D.B., Kamal, M., Clamp, M., Chang, J.L., Kulbokas, E.J., 3rd, Zody, M.C., Mauceli, E., Xie, X., Breen, M., Wayne, R.K., Ostrander, E.A., et al., 2005. Genome sequence, comparative analysis and haplotype structure of the domestic dog. *Nature* 438 (7069), 803-819.

Liston, T.E., Koehler, J.E., 1996. Granulomatous hepatitis and necrotizing splenitis due to *Bartonella henselae* in a patient with cancer: Case report and review of hepatosplenic manifestations of *Bartonella* infection. *Clin. Infect. Dis.* 22 (6), 951-957.

Lucey, D., Dolan, M.J., Moss, C.W., Garcia, M., Hollis, D.G., Wegner, S., Morgan, G., Almeida, R., Leong, D., Greisen, K.S., 1992. Relapsing illness due to *Rochalimaea henselae* in immunocompetent hosts: Implication for therapy and new epidemiological associations. *Clin. Infect. Dis.* 14 (3), 683-688.

MacDonald, K.A., Chomel, B.B., Kittleson, M.D., Kasten, R.W., Thomas, W.P., Pesavento, P., 2004. A prospective study of canine infective endocarditis in northern California (1999-2001): Emergence of *Bartonella* as a prevalent etiologic agent. *J. Vet. Intern. Med.* 18 (1), 56-64.

Mack, G.S., 2005. Cancer researchers usher in dog days of medicine. *Nat. Med.* 11 (10), 1018.

Maeno, N., Oda, H., Yoshiie, K., Wahid, M.R., Fujimura, T., Matayoshi, S., 1999. Live *Bartonella henselae* enhances endothelial cell proliferation without direct contact. *Microb. Pathog.* 27 (6), 419-427.

- Maggi, R.G., Chomel, B., Hegarty, B.C., Henn, J., Breitschwerdt, E.B., 2006. A *Bartonella vinsonii berkhoffii* typing scheme based upon 16S-23S ITS and Pap31 sequences from dog, coyote, gray fox, and human isolates. *Mol. Cell. Probes* 20 (2), 128-134.
- Maggi, R.G., Duncan, A.W., Breitschwerdt, E.B., 2005a. Novel chemically modified liquid medium that will support the growth of seven *Bartonella* species. *J. Clin. Microbiol.* 43 (6), 2651-2655.
- Maggi, R.G., Harms, C.A., Hohn, A.A., Pabst, D.A., McLellan, W.A., Walton, W.J., Rotstein, D.S., Breitschwerdt, E.B., 2005b. *Bartonella henselae* in porpoise blood. *Emerg. Infect. Dis.* 11 (12), 1894-1898.
- Maguiña, C., Gotuzzo, E., 2000. Bartonellosis: New and old. *Infect. Dis. Clin. North Am.* 14 (1), 1-22.
- Maillard, R., Grimard, B., Chastant-Maillard, S., Chomel, B., Delcroix, T., Gandoin, C., Bouillin, C., Halos, L., Vayssier-Taussat, M., Boulouis, H.J., 2006. Effects of cow age and pregnancy on *Bartonella* infection in a herd of dairy cattle. *J. Clin. Microbiol.* 44 (1), 42-46.
- Maillard, R., Petit, E., Chomel, B., Lacroux, C., Schelcher, F., Vayssier-Taussat, M., Haddad, N., Boulouis, H.J., Molecular and serological evidence of endocarditis in cattle caused by *Bartonella bovis*. Under review at *Emerging Infectious Diseases*.
- Maillard, R., Vayssier-Taussat, M., Bouillin, C., Gandoin, C., Halos, L., Chomel, B., Piemont, Y., Boulouis, H.J., 2004. Identification of *Bartonella* strains isolated from wild and domestic ruminants by a single-step PCR analysis of the 16S-23S intergenic spacer region. *Vet. Microbiol.* 98 (1), 63-69.
- Manders, S.M., 1996. Bacillary angiomatosis. *Clin. Dermatol.* 14 (3), 295-299.
- Mandle, T., Einsele, H., Schaller, M., Neumann, D., Vogel, W., Autenrieth, I.B., Kempf, V.A., 2005. Infection of human CD34+ progenitor cells with *Bartonella henselae* results in intraerythrocytic presence of *B. henselae*. *Blood* 106 (4), 1215-1222.
- Marie, J.L., Fournier, P.E., Rolain, J.M., Briolant, S., Davoust, B., Raoult, D., 2006. Molecular detection of *Bartonella quintana*, *B. elizabethae*, *B. koehlerae*, *B. doshiae*, *B. taylorii*, and *Rickettsia felis* in rodent fleas collected in Kabul, Afghanistan. *Am. J. Trop. Med. Hyg.* 74 (3), 436-439.
- Markaki, S., Sotiropoulou, M., Papaspirou, P., Lazaris, D., 2003. Cat-scratch disease presenting as a solitary tumour in the breast: Report of three cases. *Eur. J. Obstet. Gynecol. Reprod. Biol.* 106 (2), 175-178.

- Marra, C.M., 1995. Neurologic complications of *Bartonella henselae* infection. *Curr. Opin. Neurol.* 8 (3), 164-169.
- Mason, J.O., 3rd., 2004. Retinal and optic nerve neovascularization associated with cat scratch neuroretinitis. *Retina* 24 (1), 176-178.
- Matsuoka, M., 2005. Human T-cell leukemia virus type 1 (HTLV-1) infection and the onset of adult T-cell leukemia (ATL). *Retrovirology* 2 (1), 27.
- Maurin, M., Birtles, R., Raoult, D., 1997. Current knowledge of *Bartonella* species. *Eur. J. Clin. Microbiol. Infect. Dis.* 16 (7), 487-506.
- Maurin, M., Gasquet, S., Ducrocq, C., Raoult, D., 1995. MICs of 28 antibiotic compounds for 14 *Bartonella* (formerly *Rochalimaea*) isolates. *Antimicrob. Agents Chemother.* 39 (11), 2387-2391.
- Maurin, M., Raoult, D., 1996. *Bartonella* (*Rochalimaea*) *quintana* infections. *Clin. Microbiol. Rev.* 9 (3), 273-292.
- McCord, A.M., Burgess, A.W., Whaley, M.J., Anderson, B.E., 2005. Interaction of *Bartonella henselae* with endothelial cells promotes monocyte/macrophage chemoattractant protein 1 gene expression and protein production and triggers monocyte migration. *Infect. Immun.* 73 (9), 5735-5742.
- McGill, S., Hjelm, E., Rajs, J., Lindquist, O., Friman, G., 2003. *Bartonella* spp. antibodies in forensic samples from Swedish heroin addicts. *Ann. N. Y. Acad. Sci.* 990,409-413.
- McGill, S., Wesslen, L., Hjelm, E., Holmberg, M., Rolf, C., Friman, G., 2001. Serological and epidemiological analysis of the prevalence of *Bartonella* spp. antibodies in Swedish elite orienteers 1992-93. *Scand. J. Infect. Dis.* 33 (6), 423-428.
- Meghari, S., Rolain, J.M., Grau, G.E., Platt, E., Barrassi, L., Mege, J.L., Raoult, D., 2006. Antiangiogenic effect of erythromycin: An *in vitro* model of *Bartonella quintana* infection. *J. Infect. Dis.* 193 (3), 380-386.
- Meininger, G.R., Nadasdy, T., Hruban, R.H., Bollinger, R.C., Baughman, K.L., Hare, J.M., 2001. Chronic active myocarditis following acute *Bartonella henselae* infection (cat scratch disease). *Am. J. Surg. Pathol.* 25 (9), 1211-1214.
- Merrell, D.S., Falkow, S., 2004. Frontal and stealth attack strategies in microbial pathogenesis. *Nature* 430 (6996), 250-256.
- Mexas, A.M., Hancock, S.I., Breitschwerdt, E.B., 2002. *Bartonella henselae* and *Bartonella elizabethae* as potential canine pathogens. *J. Clin. Microbiol.* 40 (12), 4670-4674.

- Michau, T.M., Breitschwerdt, E.B., Gilger, B.C., Davidson, M.G., 2003. *Bartonella vinsonii* subspecies *berkhoffii* as a possible cause of anterior uveitis and choroiditis in a dog. *Vet. Ophthalmol.* 6 (4), 299-304.
- Miles, S.A., 1994. Pathogenesis of HIV-related Kaposi's sarcoma. *Curr. Opin. Oncol.* 6 (5), 497-502.
- Mohle-Boetani, J.C., Koehler, J.E., Berger, T.G., LeBoit, P.E., Kemper, C.A., Reingold, A.L., Plikaytis, B.D., Wenger, J.D., Tappero, J.W., 1996. Bacillary angiomatosis and bacillary peliosis in patients infected with human immunodeficiency virus: Clinical characteristics in a case-control study. *Clin. Infect. Dis.* 22 (5), 794-800.
- Morales, S.C., Breitschwerdt, E.B., Washabau, R.J., Matise, I., Maggi, R.G., Duncan, A.W., 2007. Detection of *Bartonella henselae* DNA in two dogs with pyogranulomatous lymphadenitis. *J. Am. Vet. Med. Assoc.* 230 (5), 681-685.
- Morgner, A., Miehle, S., Fischbach, W., Schmitt, W., Muller-Hermelink, H., Greiner, A., Thiede, C., Schetelig, J., Neubauer, A., Stolte, M., Ehninger, G., Bayerdorffer, E., 2001. Complete remission of primary high-grade B-cell gastric lymphoma after cure of *Helicobacter pylori* infection. *J. Clin. Oncol.* 19 (7), 2041-2048.
- Morozova, O.V., Cabello, F.C., Dobrotvorsky, A.K., 2004. Semi-nested PCR detection of *Bartonella henselae* in *Ixodes persulcatus* ticks from western Siberia, Russia. *Vector Borne Zoonotic Dis.* 4 (4), 306-309.
- Muller, S., Boulouis, H.J., Viallard, J., Beugnet, F., 2004. Epidemiological survey of canine bartonellosis to *Bartonella vinsonii* subs. *berkhoffii* and canine monocytic ehrlichiosis in dogs on the Island of Reunion. *Revue Med. Vet.* 155 377-380.
- Mylonakis, M.E., Koutinas, A.F., Breitschwerdt, E.B., Hegarty, B.C., Billinis, C.D., Leontides, L.S., Kontos, V.S., 2004. Chronic canine ehrlichiosis (*Ehrlichia canis*): A retrospective study of 19 natural cases. *J. Am. Anim. Hosp. Assoc.* 40 (3), 174-184.
- Nagai, H., Roy, C.R., 2003. Show me the substrates: Modulation of host cell function by type IV secretion systems. *Cell. Microbiol.* 5 (6), 373-383.
- Naito, Y., Yoshikawa, T., 2002. Molecular and cellular mechanisms involved in *Helicobacter pylori*-induced inflammation and oxidative stress. *Free Radic. Biol. Med.* 33 (3), 323-336.
- Nasti, G., Vaccher, E., Errante, D., Tirelli, U., 1997. Malignant tumors and AIDS. *Biomed. Pharmacother.* 51 (6-7), 243-251.
- National Toxicology Program (NTP), 2005. Report on Carcinogens, Eleventh edition. U.S. Department of Health and Human Services, Public Health Service.

- Noah, D.L., Bresee, J.S., Gorenssek, M.J., Rooney, J.A., Cresanta, J.L., Regnery, R.L., Wong, J., del Toro, J., Olson, J.G., Childs, J.E., 1995. Cluster of five children with acute encephalopathy associated with cat-scratch disease in south Florida. *Pediatr. Infect. Dis. J.* 14 (10), 866-869.
- O'Connor, S.P., Dorsch, M., Steigerwalt, A.G., Brenner, D.J., Stackebrandt, E., 1991. 16S rRNA sequences of *Bartonella bacilliformis* and cat scratch disease bacillus reveal phylogenetic relationships with the alpha-2 subgroup of the class proteobacteria. *J. Clin. Microbiol.* 29 (10), 2144-2150.
- O'Halloran, H.S., Draud, K., Minix, M., Rivard, A.K., Pearson, P.A., 1998. Leber's neuroretinitis in a patient with serologic evidence of *Bartonella elizabethae*. *Retina* 18 (3), 276-278.
- Ormerod, L.D., Dailey, J.P., 1999. Ocular manifestations of cat-scratch disease. *Curr. Opin. Ophthalmol.* 10 (3), 209-216.
- O'Rourke, L.G., Pitulle, C., Hegarty, B.C., Kraycirik, S., Killary, K.A., Grosenstein, P., Brown, J.W., Breitschwerdt, E.B., 2005. *Bartonella quintana* in cynomolgus monkey (*Macaca fascicularis*). *Emerg. Infect. Dis.* 11 (12), 1931-1934.
- Ostrander, E.A., Galibert, F., Patterson, D.F., 2000. Canine genetics comes of age. *Trends Genet.* 16 (3), 117-124.
- Pagano, J.S., 1999. Epstein-Barr virus: The first human tumor virus and its role in cancer. *Proc. Assoc. Am. Physicians* 111 (6), 573-580.
- Pappalardo, B.L., Brown, T., Gebhardt, D., Sontakke, S., Breitschwerdt, E.B., 2000a. Cyclic CD8+ lymphopenia in dogs experimentally infected with *Bartonella vinsonii* subsp. *berkhoffii*. *Vet. Immunol. Immunopathol.* 75 (1-2), 43-57.
- Pappalardo, B.L., Brown, T., Gookin, J.L., Morrill, C.L., Breitschwerdt, E.B., 2000b. Granulomatous disease associated with *Bartonella* infection in 2 dogs. *J. Vet. Intern. Med.* 14 (1), 37-42.
- Pappalardo, B.L., Brown, T.T., Tompkins, M., Breitschwerdt, E.B., 2001. Immunopathology of *Bartonella vinsonii* (*berkhoffii*) in experimentally infected dogs. *Vet. Immunol. Immunopathol.* 83 (3-4), 125-147.
- Pappalardo, B.L., Correa, M.T., York, C.C., Peat, C.Y., Breitschwerdt, E.B., 1997. Epidemiologic evaluation of the risk factors associated with exposure and seroreactivity to *Bartonella vinsonii* in dogs. *Am. J. Vet. Res.* 58 (5), 467-471.

- Parrott, J.H., Dure, L., Sullender, W., Buraphacheep, W., Frye, T.A., Galliani, C.A., Marston, E., Jones, D., Regnery, R., 1997. Central nervous system infection associated with *Bartonella quintana*: A report of two cases. *Pediatrics* 100 (3 - Pt 1), 403-408.
- Parsonnet, J., Friedman, G.D., Vandersteen, D.P., Chang, Y., Vogelman, J.H., Orentreich, N., Sibley, R.K., 1991. *Helicobacter pylori* infection and the risk of gastric carcinoma. *N. Engl. J. Med.* 325 (16), 1127-1131.
- Patnaik, M., Peter, J.B., 1995. Cat-scratch disease, *Bartonella henselae*, and the usefulness of routine serological testing for *Afipia felis*. *Clin. Infect. Dis.* 21 (4), 1064.
- Patterson, D.F., 2000. Companion animal medicine in the age of medical genetics. *J. Vet. Intern. Med.* 14 (1), 1-9.
- Paul, M.A., Fleischer, A.B., Jr, Wieselthier, J.S., White, W.L., 1994. Bacillary angiomatosis in an immunocompetent child: The first reported case. *Pediatr. Dermatol.* 11 (4), 338-341.
- Perkocha, L.A., Geaghan, S.M., Yen, T.S., Nishimura, S.L., Chan, S.P., Garcia-Kennedy, R., Honda, G., Stoloff, A.C., Klein, H.Z., Goldman, R.L., 1990. Clinical and pathological features of bacillary peliosis hepatitis in association with human immunodeficiency virus infection. *N. Engl. J. Med.* 323 (23), 1581-1586.
- Pesavento, P.A., Chomel, B.B., Kasten, R.W., McDonald, K.A., Mohr, F.C., 2005. Pathology of *Bartonella* endocarditis in six dogs. *Vet. Pathol.* 42 (3), 370-373.
- Pitulle, C., Strehse, C., Brown, J.W., Breitschwerdt, E.B., 2002. Investigation of the phylogenetic relationships within the genus *Bartonella* based on comparative sequence analysis of the *rnpB* gene, 16S rDNA and 23S rDNA. *Int. J. Syst. Evol. Microbiol.* 52 (Pt 6), 2075-2080.
- Rabkin, C.S., 2001. AIDS and cancer in the era of highly active antiretroviral therapy (HAART). *Eur. J. Cancer* 37 (10), 1316-1319.
- Raoult, D., Birtles, R.J., Montoya, M., Perez, E., Tissot-Dupont, H., Roux, V., Guerra, H., 1999. Survey of three bacterial louse-associated diseases among rural Andean communities in Peru: Prevalence of epidemic typhus, trench fever, and relapsing fever. *Clin. Infect. Dis.* 29 (2), 434-436.
- Raoult, D., Drancourt, M., Carta, A., Gastaut, J.A., 1994. *Bartonella (Rochalimaea) quintana* isolation in patient with chronic adenopathy, lymphopenia, and a cat. *Lancet* 343 (8903), 977.

- Raoult, D., Fournier, P.E., Drancourt, M., Marrie, T.J., Etienne, J., Cosserat, J., Cacoub, P., Poinsignon, Y., Leclercq, P., Sefton, A.M., 1996. Diagnosis of 22 new cases of *Bartonella* endocarditis. *Ann. Intern. Med.* 125 (8), 646-652.
- Raoult, D., Fournier, P.E., Vandenesch, F., Mainardi, J.L., Eykyn, S.J., Nash, J., James, E., Benoit-Lemercier, C., Marrie, T.J., 2003. Outcome and treatment of *Bartonella* endocarditis. *Arch. Intern. Med.* 163 (2), 226-230.
- Raoult, D., La Scola, B., Kelly, P.J., Davoust, B., Gomez, J., 2005. *Bartonella bovis* in cattle in Africa. *Vet. Microbiol.* 105 (2), 155-156.
- Raoult, D., Roblot, F., Rolain, J.M., Besnier, J.M., Loulergue, J., Bastides, F., Choutet, P., 2006. First isolation of *Bartonella alsatica* from a valve of a patient with endocarditis. *J. Clin. Microbiol.* 44 (1), 278-279.
- Raoult, D., Roux, V., 1999. The body louse as a vector of reemerging human diseases. *Clin. Infect. Dis.* 29 (4), 888-911.
- Reed, J.A., Brigati, D.J., Flynn, S.D., McNutt, N.S., Min, K.W., Welch, D.F., Slater, L.N., 1992. Immunocytochemical identification of *Rochalimaea henselae* in bacillary (epithelioid) angiomatosis, parenchymal bacillary peliosis, and persistent fever with bacteremia. *Am. J. Surg. Pathol.* 16 (7), 650-657.
- Reeves, W.K., Nelder, M.P., Cobb, K.D., Dasch, G.A., 2006. *Bartonella* spp. in deer keds, *Lipoptena mazamae* (Diptera: Hippoboscidae), from Georgia and South Carolina, USA. *J. Wildl. Dis.* 42 (2), 391-396.
- Regnery, R., Marano, N., Jameson, P., Marston, E., Jones, D., Handley, S., Goldsmith, C., Greene, C., 2000. A fourth *Bartonella* species, *B. weissii* species nova, isolated from domestic cats. 15th Meeting of the American Society of Rickettsiology, abstract 4. GenBank Accession No. AF071190 at <http://www.ncbi.nlm.nih.gov>.
- Regnery, R.L., Anderson, B.E., Clarridge, J.E., 3rd, Rodriguez-Barradas, M.C., Jones, D.C., Carr, J.H., 1992a. Characterization of a novel *Rochalimaea* species, *R. henselae* sp. nov., isolated from blood of a febrile, human immunodeficiency virus-positive patient. *J. Clin. Microbiol.* 30 (2), 265-274.
- Regnery, R.L., Olson, J.G., Perkins, B.A., Bibb, W., 1992b. Serological response to “*Rochalimaea henselae*” antigen in suspected cat-scratch disease. *Lancet* 339 (8807), 1443-1445.
- Relman, D.A., 1995. Has trench fever returned? *N. Engl. J. Med.* 332 (7), 463-464.

Relman, D.A., Loutit, J.S., Schmidt, T.M., Falkow, S., Tompkins, L.S., 1990. The agent of bacillary angiomatosis. an approach to the identification of uncultured pathogens. N. Engl. J. Med. 323 (23), 1573-1580.

Resto-Ruiz, S., Burgess, A., Anderson, B.E., 2003. The role of the host immune response in pathogenesis of *Bartonella henselae*. DNA Cell Biol. 22 (6), 431-440.

Resto-Ruiz, S.I., Schmiederer, M., Sweger, D., Newton, C., Klein, T.W., Friedman, H., Anderson, B.E., 2002. Induction of a potential paracrine angiogenic loop between human THP-1 macrophages and human microvascular endothelial cells during *Bartonella henselae* infection. Infect. Immun. 70 (8), 4564-4570.

Ridder, G.J., Boedeker, C.C., Technau-Ihling, K., Grunow, R., Sander, A., 2002. Role of cat-scratch disease in lymphadenopathy in the head and neck. Clin. Infect. Dis. 35 (6), 643-649.

Robinson, J.L., Spady, D.W., Prasad, E., McColl, D., Artsob, H., 2005. *Bartonella* seropositivity in children with Henoch-Schonlein purpura. BMC Infect. Dis. 5 (1), 21.

Rolain, J.M., Brouqui, P., Koehler, J.E., Maguina, C., Dolan, M.J., Raoult, D., 2004. Recommendations for treatment of human infections caused by *Bartonella* species. Antimicrob. Agents Chemother. 48 (6), 1921-1933.

Rolain, J.M., Foucault, C., Brouqui, P., Raoult, D., 2003. Erythroblast cells as a target for *Bartonella quintana* in homeless people. Ann. N. Y. Acad. Sci. 990, 485-487.

Rolain, J.M., Foucault, C., Guieu, R., La Scola, B., Brouqui, P., Raoult, D., 2002. *Bartonella quintana* in human erythrocytes. Lancet 360 (9328), 226-228.

Rolain, J.M., Franc, M., Davoust, B., Raoult, D., 2003a. Molecular detection of *Bartonella quintana*, *B. koehlerae*, *B. henselae*, *B. clarridgeiae*, *Rickettsia felis*, and *Wolbachia pipientis* in cat fleas, France. Emerg. Infect. Dis. 9 (3), 338-342.

Rolain, J.M., Gouriet, F., Enea, M., Aboud, M., Raoult, D., 2003b. Detection by immunofluorescence assay of *Bartonella henselae* in lymph nodes from patients with cat scratch disease. Clin. Diagn. Lab. Immunol. 10 (4), 686-691.

Rolain, J.M., La Scola, B., Liang, Z., Davoust, B., Raoult, D., 2001. Immunofluorescent detection of intraerythrocytic *Bartonella henselae* in naturally infected cats. J. Clin. Microbiol. 39 (8), 2978-2980.

Rolain, J.M., Lepidi, H., Zanaret, M., Triglia, J.M., Michel, G., Thomas, P.A., Texereau, M., Stein, A., Romaru, A., Eb, F., Raoult, D., 2006. Lymph node biopsy specimens and diagnosis of cat-scratch disease. Emerg. Infect. Dis. 12 (9), 1338-1344.

Roux, V., Eykyn, S.J., Wyllie, S., Raoult, D., 2000. *Bartonella vinsonii* subsp. *berkhoffii* as an agent of afebrile blood culture-negative endocarditis in a human. J. Clin. Microbiol. 38 (4), 1698-1700.

Rudikoff, D., Phelps, R.G., Gordon, R.E., Battone, E.J., 1989. Acquired immunodeficiency syndrome-related bacillary vascular proliferation (epithelioid angiomatosis): Rapid response to erythromycin therapy. Arch. Dermatol. 125 (5), 706-707.

Rydkina, E.B., Roux, V., Gagau, E.M., Predtechenski, A.B., Tarasevich, I.V., Raoult, D., 1999. *Bartonella quintana* in body lice collected from homeless persons in Russia. Emerg. Infect. Dis. 5 (1), 176-178.

Sanogo, Y.O., Zeaiter, Z., Caruso, G., Merola, F., Shpynov, S., Brouqui, P., Raoult, D., 2003. *Bartonella henselae* in *Ixodes ricinus* ticks (Acari: Ixodida) removed from humans, Belluno province, Italy. Emerg. Infect. Dis. 9 (3), 329-332.

Sasaki, T., Kobayashi, M., Agui, N., 2002. Detection of *Bartonella quintana* from body lice (Anoplura: Pediculidae) infesting homeless people in Tokyo by molecular technique. J. Med. Entomol. 39 (3), 427-429.

Saunders, G.K., Monroe, W.E., 2006. Systemic granulomatous disease and sialometaplasia in a dog with *Bartonella* infection. Vet. Pathol. 43 (3), 391-392.

Sauter, C., 1995. Is Hodgkin's disease a human counterpart of bacterially induced crown-gall tumours? Lancet 346 (8987), 1433.

Sauter, C., Blum, S., 2003. Regression of lung lesions in Hodgkin's disease by antibiotics: Case report and hypothesis on the etiology of Hodgkin's disease. Am. J. Clin. Oncol. 26 (1), 92-94.

Schiellerup, P., Dyhr, T., Rolain, J.M., Christensen, M., Damsgaard, R., Ethelberg, S., Fisker, N., Frost Andersen, N., Raoult, D., Kroghelt, K.A., 2004. Low seroprevalence of *Bartonella* species in Danish elite orienteers. Scand. J. Infect. Dis. 36 (8), 604-606.

Schmid, M.C., Schulein, R., Dehio, M., Denecker, G., Carena, I., Dehio, C., 2004. The VirB type IV secretion system of *Bartonella henselae* mediates invasion, proinflammatory activation and antiapoptotic protection of endothelial cells. Mol. Microbiol. 52 (1), 81-92.

Schroder, G., Dehio, C., 2005. Virulence-associated type IV secretion systems of *Bartonella*. Trends Microbiol. 13 (7), 336-342.

Schulein, R., Dehio, C., 2002. The VirB/VirD4 type IV secretion system of *Bartonella* is essential for establishing intraerythrocytic infection. Mol. Microbiol. 46 (4), 1053-1067.

- Schulein, R., Guye, P., Rhomberg, T.A., Schmid, M.C., Schroder, G., Vergunst, A.C., Carena, I., Dehio, C., 2005. A bipartite signal mediates the transfer of type IV secretion substrates of *Bartonella henselae* into human cells. *Proc. Natl. Acad. Sci. U. S. A.* 102 (3), 856-861.
- Schwartzman, W.A., Nesbit, C.A., Baron, E.J., 1993. Development and evaluation of a blood-free medium for determining growth curves and optimizing growth of *Rochalimaea henselae*. *J. Clin. Microbiol.* 31 (7), 1882-1885.
- Seubert, A., Hiestand, R., de la Cruz, F., Dehio, C., 2003. A bacterial conjugation machinery recruited for pathogenesis. *Mol. Microbiol.* 49 (5), 1253-1266.
- Seubert, A., Schulein, R., Dehio, C., 2002. Bacterial persistence within erythrocytes: A unique pathogenic strategy of *Bartonella* spp. *Int. J. Med. Microbiol.* 291 (6-7), 555-560.
- Siman, J.H., Forsgren, A., Berglund, G., Floren, C.H., 1997. Association between *Helicobacter pylori* and gastric carcinoma in the city of Malmo, Sweden. A prospective study. *Scand. J. Gastroenterol.* 32 (12), 1215-1221.
- Simiantonaki, N., Jayasinghe, C., Kirkpatrick, C.J., 2002. Effect of pro-inflammatory stimuli on tumor cell-mediated induction of endothelial cell adhesion molecules *in vitro*. *Exp. Mol. Pathol.* 73 (1), 46-53.
- Slater, L.N., Welch, D.F., Hensel, D., Coody, D.W., 1990. A newly recognized fastidious gram-negative pathogen as a cause of fever and bacteremia. *N. Engl. J. Med.* 323 (23), 1587-1593.
- Slater, L.N., Welch, D.F., Min, K.W., 1992. *Rochalimaea henselae* causes bacillary angiomatosis and peliosis hepatis. *Arch. Intern. Med.* 152 (3), 602-606.
- Smarick, S.D., Jandrey, K.E., Chomel, B.B., Thomas, W.P., Aldrich, J., 2004. Aortic valvular endocarditis caused by *Bartonella vinsonii* subsp. *berkhoffii* in 2 dogs presenting for fulminant pulmonary edema. *J. Vet. Emer. Crit. Care* 14 (1), 42-51.
- Smith, H.M., Reporter, R., Rood, M.P., Linscott, A.J., Mascola, L.M., Hogrefe, W., Purcell, R.H., 2002. Prevalence study of antibody to ratborne pathogens and other agents among patients using a free clinic in downtown Los Angeles. *J. Infect. Dis.* 186 (11), 1673-1676.
- Solano-Gallego, L., Bradley, J., Hegarty, B., Sigmon, B., Breitschwerdt, E., 2004. *Bartonella henselae* IgG antibodies are prevalent in dogs from southeastern USA. *Vet. Res.* 35 (5), 585-595.

Solano-Gallego, L., Llull, J., Osso, M., Hegarty, B., Breitschwerdt, E., 2006. A serological study of exposure to arthropod-borne pathogens in dogs from northeastern Spain. *Vet. Res.* 37 (2), 231-244.

Spach, D.H., Callis, K.P., Paauw, D.S., Houze, Y.B., Schoenknecht, F.D., Welch, D.F., Rosen, H., Brenner, D.J., 1993. Endocarditis caused by *Rochalimaea quintana* in a patient infected with human immunodeficiency virus. *J. Clin. Microbiol.* 31 (3), 692-694.

Spach, D.H., Kanter, A.S., Dougherty, M.J., Larson, A.M., Coyle, M.B., Brenner, D.J., Swaminathan, B., Matar, G.M., Welch, D.F., Root, R.K., 1995. *Bartonella (Rochalimaea) quintana* bacteremia in inner-city patients with chronic alcoholism. *N. Engl. J. Med.* 332 (7), 424-428.

Spach, D.H., Koehler, J.E., 1998. *Bartonella*-associated infections. *Infect. Dis. Clin. North Am.* 12 (1), 137-155.

Starkey, M.P., Scase, T.J., Mellersh, C.S., Murphy, S., 2005. Dogs really are man's best friend--canine genomics has applications in veterinary and human medicine! *Brief Funct. Genomic Proteomic* 4 (2), 112-128.

Stoler, M.H., Bonfiglio, T.A., Steigbigel, R.T., Pereira, M., 1983. An atypical subcutaneous infection associated with acquired immune deficiency syndrome. *Am. J. Clin. Pathol.* 80 (5), 714-718.

Suksawat, J., Xuejie, Y., Hancock, S.I., Hegarty, B.C., Nilkumhang, P., Breitschwerdt, E.B., 2001. Serologic and molecular evidence of coinfection with multiple vector-borne pathogens in dogs from Thailand. *J. Vet. Intern. Med.* 15 (5), 453-462.

Swift, H.F., 1920. Trench fever. *Arch. Internal Med.* 26, 79-98.

Sykes, J.E., Kittleson, M.D., Pesavento, P.A., Byrne, B.A., MacDonald, K.A., Chomel, B.B., 2006. Evaluation of the relationship between causative organisms and clinical characteristics of infective endocarditis in dogs: 71 cases (1992-2005). *J. Am. Vet. Med. Assoc.* 228 (11), 1723-1734.

Szelc-Kelly, C.M., Goral, S., Perez-Perez, G.I., Perkins, B.A., Regnery, R.L., Edwards, K.M., 1995. Serologic responses to *Bartonella* and *Afipia* antigens in patients with cat scratch disease. *Pediatrics* 96 (6), 1137-1142.

Takeda, S., Maeda, M., Morikawa, S., Taniguchi, Y., Yasunaga, J., Nosaka, K., Tanaka, Y., Matsuoka, M., 2004. Genetic and epigenetic inactivation of tax gene in adult T-cell leukemia cells. *Int. J. Cancer* 109 (4), 559-567.

- Tamiya, S., Matsuoka, M., Etoh, K., Watanabe, T., Kamihira, S., Yamaguchi, K., Takatsuki, K., 1996. Two types of defective human T-lymphotropic virus type I provirus in adult T-cell leukemia. *Blood* 88 (8), 3065-3073.
- Tappero, J.W., Koehler, J.E., Berger, T.G., Cockerell, C.J., Lee, T.H., Busch, M.P., Stites, D.P., Mohle-Boetani, J., Reingold, A.L., LeBoit, P.E., 1993a. Bacillary angiomatosis and bacillary splenitis in immunocompetent adults. *Ann. Intern. Med.* 118 (5), 363-365.
- Tappero, J.W., Mohle-Boetani, J., Koehler, J.E., Swaminathan, B., Berger, T.G., LeBoit, P.E., Smith, L.L., Wenger, J.D., Pinner, R.W., Kemper, C.A., 1993b. The epidemiology of bacillary angiomatosis and bacillary peliosis. *JAMA* 269 (6), 770-775.
- Taylor, L.H., Latham, S.M., Woolhouse, M.E., 2001. Risk factors for human disease emergence. *Philos. Trans. R. Soc. Lond. B. Biol. Sci.* 356 (1411), 983-989.
- Townsend, C.H.T., 1914. Resumen de la labores en el peru sobre el *Phlebotomus verrucarum* y su agencia en la transmission de la verruga. *An. Zool. Aplicada* 1, 44.
- Tsujino, K., Tsukahara, M., Tsuneoka, H., Ichihara, K., Furuya, T., Kawauchi, S., Oga, A., Sasaki, K., 2004. Clinical implication of prolonged fever in children with cat scratch disease. *J. Infect. Chemother.* 10 (4), 227-233.
- Tsukahara, M., Tsuneoka, H., Iino, H., Murano, I., Takahashi, H., Uchida, M., 2000. *Bartonella henselae* infection as a cause of fever of unknown origin. *J. Clin. Microbiol.* 38 (5), 1990-1991.
- Tsukahara, M., Tsuneoka, H., Iino, H., Ohno, K., Murano, I., 1998. *Bartonella henselae* infection from a dog. *Lancet* 352 (9141), 1682.
- Turgut, M., Alabaz, D., Karakas, M., Kavak, M., Aksaray, N., Alhan, E., Cevlik, F., Tuncer, I., 2004. Bacillary angiomatosis in an immunocompetent child with a grafted traumatic wound. *J. Dermatol.* 31 (10), 844-847.
- Tuttle, A.D., Birkenheuer, A.J., Juopperi, T., Levy, M.G., Breitschwerdt, E.B., 2003. Concurrent bartonellosis and babesiosis in a dog with persistent thrombocytopenia. *J. Am. Vet. Med. Assoc.* 223 (9), 1306-10, 1280-1281.
- Uemura, N., Okamoto, S., Yamamoto, S., Matsumura, N., Yamaguchi, S., Yamakido, M., Taniyama, K., Sasaki, N., Schlemper, R.J., 2001. *Helicobacter pylori* infection and the development of gastric cancer. *N. Engl. J. Med.* 345 (11), 784-789.
- Verma, A., Davis, G.E., Ihler, G.M., 2001. Formation of stress fibres in human endothelial cells infected with *Bartonella bacilliformis* is associated with altered morphology, impaired migration and defects in cell morphogenesis. *Cell. Microbiol.* 3 (3), 169-180.

- Vermi, W., Facchetti, F., Riboldi, E., Heine, H., Scutera, S., Stornello, S., Ravarino, D., Cappello, P., Giovarelli, M., Badolato, R., Zucca, M., Gentili, F., Chilosi, M., Doglioni, C., Ponzi, A.N., Sozzani, S., Musso, T., 2006. Role of dendritic cell-derived CXCL13 in the pathogenesis of *Bartonella henselae* B-rich granuloma. *Blood* 107 (2), 454-462.
- Vinson, J.W., Fuller, H.S., 1961. Studies on trench fever. I. Propagation of *Rickettsia*-like microorganisms from a patient's blood. *Pathol. Microbiol. (Basel)* 24 (Suppl), 152-166.
- Von Roenn, J.H., 2003. Clinical presentations and standard therapy of AIDS-associated Kaposi's sarcoma. *Hematol. Oncol. Clin. North Am.* 17 (3), 747-762.
- Walboomers, J.M., Jacobs, M.V., Manos, M.M., Bosch, F.X., Kummer, J.A., Shah, K.V., Snijders, P.J., Peto, J., Meijer, C.J., Munoz, N., 1999. Human papillomavirus is a necessary cause of invasive cervical cancer worldwide. *J. Pathol.* 189 (1), 12-19.
- Wear, D.J., Margileth, A.M., Hadfield, T.L., Fischer, G.W., Schlagel, C.J., King, F.M., 1983. Cat scratch disease: A bacterial infection. *Science* 221 (4618), 1403-1405.
- Webster, G.F., Cockerell, C.J., Friedman-Kien, A.E., 1992. The clinical spectrum of bacillary angiomatosis. *Br. J. Dermatol.* 126 (6), 535-541.
- Weiss, E., Dasch, G.A., 1982. Differential characteristics of strains of *Rochalimaea*: *Rochalimaea vinsonii* sp. nov., the Canadian vole agent. *Int. J. Syst. Bacteriol.* 32, 305-314.
- Weiss, E., Dasch, G.A., Woodman, D.R., Williams, J.C., 1978. Vole agent identified as a strain of the trench fever rickettsia, *Rochalimaea quintana*. *Infect. Immun.* 19 (3), 1013-1020.
- Welch, D.F., Carroll, K.C., Hofmeister, E.K., Persing, D.H., Robison, D.A., Steigerwalt, A.G., Brenner, D.J., 1999. Isolation of a new subspecies, *Bartonella vinsonii* subsp. *arupensis*, from a cattle rancher: Identity with isolates found in conjunction with *Borrelia burgdorferi* and *Babesia microti* among naturally infected mice. *J. Clin. Microbiol.* 37 (8), 2598-2601.
- Welch, D.F., Pickett, D.A., Slater, L.N., Steigerwalt, A.G., Brenner, D.J., 1992. *Rochalimaea henselae* sp. nov., a cause of septicemia, bacillary angiomatosis, and parenchymal bacillary peliosis. *J. Clin. Microbiol.* 30 (2), 275-280.
- Wesslen, L., Ehrenborg, C., Holmberg, M., McGill, S., Hjelm, E., Lindquist, O., Henriksen, E., Rolf, C., Larsson, E., Friman, G., 2001. Subacute *Bartonella* infection in Swedish orienteers succumbing to sudden unexpected cardiac death or having malignant arrhythmias. *Scand. J. Infect. Dis.* 33 (6), 429-438.

Wesslen, L., Pahlson, C., Lindquist, O., Hjelm, E., Gnarpe, J., Larsson, E., Baandrup, U., Eriksson, L., Fohlman, J., Engstrand, L., Linglof, T., Nystrom-Rosander, C., Gnarpe, H., Magnus, L., Rolf, C., Friman, G., 1996. An increase in sudden unexpected cardiac deaths among young Swedish orienteers during 1979-1992. *Eur. Heart J.* 17 (6), 902-910.

Wong, A.K., Alfert, M., Castrillon, D.H., Shen, Q., Holash, J., Yancopoulos, G.D., Chin, L., 2001. Excessive tumor-elaborated VEGF and its neutralization define a lethal paraneoplastic syndrome. *Proc. Natl. Acad. Sci. U. S. A.* 98 (13), 7481-7486.

Wong, M.T., Dolan, M.J., Lattuada, C.P., Jr, Regnery, R.L., Garcia, M.L., Mokulis, E.C., LaBarre, R.A., Ascher, D.P., Delmar, J.A., Kelly, J.W., 1995. Neuroretinitis, aseptic meningitis, and lymphadenitis associated with *Bartonella (Rochalimaea) henselae* infection in immunocompetent patients and patients infected with human immunodeficiency virus type 1. *Clin. Infect. Dis.* 21 (2), 352-360.

Wong, T.Z., Kruskal, J., Kane, R.A., Trey, G., 1996. Cat-scratch disease simulating lymphoma. *J. Comput. Assist. Tomogr.* 20 (1), 165-166.

World Health Organization, 2006. 10 facts about cancer. WHO Fact File at <http://www.who.int/topics/cancer/en/>.

Wotherspoon, A.C., Ortiz-Hidalgo, C., Falzon, M.R., Isaacson, P.G., 1991. *Helicobacter pylori*-associated gastritis and primary B-cell gastric lymphoma. *Lancet* 338 (8776), 1175-1176.

Zangwill, K.M., Hamilton, D.H., Perkins, B.A., Regnery, R.L., Plikaytis, B.D., Hadler, J.L., Cartter, M.L., Wenger, J.D., 1993. Cat scratch disease in Connecticut: Epidemiology, risk factors, and evaluation of a new diagnostic test. *N. Engl. J. Med.* 329 (1), 8-13.

**Chapter 2. A novel chemically modified liquid medium that
will support the growth of seven *Bartonella* species**

Manuscript as published in the Journal of Clinical Microbiology.

Maggi, R.G., Duncan, A.W., Breitschwerdt, E.B., 2005. Novel chemically modified liquid medium that will support the growth of seven *Bartonella* species. J. Clin. Microbiol. 43 (6), 2651-2655.

**A novel chemically modified liquid medium that will support the growth of seven
Bartonella species**

Running Title: Novel liquid media supporting *Bartonella* species

Ricardo G. Maggi, Ashlee W. Duncan, and Edward B. Breitschwerdt*

Department of Clinical Sciences, College of Veterinary Medicine, North Carolina State
University, Raleigh, North Carolina, 27606, USA

*Corresponding author

Department of Clinical Sciences

College of Veterinary Medicine

North Carolina State University

4700 Hillsborough Street

Raleigh, NC 27606

Phone: (919) 513-6234

Fax: (919) 513-6336

E-mail: ed_breitschwerdt@ncsu.edu

Keywords: alpha *Proteobacteria*, fastidious growth, insect-based liquid culture medium,
Bartonella species

Abstract

Bacteria of the genus *Bartonella*, a member of the alpha *Proteobacteria* group, are fastidious, gram-negative, aerobic bacilli that comprise numerous species, subspecies, and subtypes. In human and veterinary medicine, species isolation remains a vital component of the diagnostic and therapeutic management of *Bartonella* infection. We describe a novel, chemically modified, insect-based liquid culture medium that supports the growth of at least seven *Bartonella* species. This medium will also support co-cultures, consisting of different *Bartonella* species, and facilitated the primary isolation of *Bartonella henselae* from blood and aqueous fluid of naturally infected cats. This liquid growth medium may provide an advantage over conventional direct blood agar plating for the diagnostic confirmation of bartonellosis.

Introduction

Due to their zoonotic potential and vector transmission, which includes sandflies, lice, fleas, and ticks, and their frequent adaptation to a mammalian reservoir host, *Bartonella* species are considered among the newest and most significant emerging pathogens.^{2,3,8,12,27,29,45} These bacteria are highly adapted to a mammalian reservoir host; further, these organisms have been shown to cause a long-lasting intraerythrocytic bacteremia both in humans and animals.^{11,14,22,24,25,37} *Bartonella* species are also the causative agent of Carrion's disease (Oroya fever and verruga peruana) (*B. bacilliformis*),⁶ trench fever (*B. quintana*),^{11,40, 43} endocarditis (*B. elizabethae*, *B. henselae*, *B. vinsonii*

subspecies *berkhoffii*, *B. washoensis*, *B. clarridgeae*),^{3,7,9,16,17,21,40,44} bacillary angiomatosis in immunocompromised patients (*B. quintana*, *B. henselae*),^{14,30,48} neuroretinitis (*B. grahamii*),²⁸ and cat scratch disease (*B. henselae*, *B. clarridgeiae*).^{5,31,42}

Because *Bartonella* species frequently induce persistent intravascular infections, it has been difficult to attribute chronic disease causation to infection in humans and companion animals; much of this difficulty may be related to the few and often very subtle clinical abnormalities that are reported by a patient or observed in a sick animal. Confirming disease causation is especially difficult in retrospective or prospective animal studies in which *Bartonella* bacteremia can be detected in overtly healthy, natural reservoir hosts—a paradigm to Koch’s postulates for disease causation.^{12,23} Nevertheless, an increasingly diverse spectrum of *Bartonella*-associated infections have been recognized in people and in dogs due to the development of new approaches to improving serologic and molecular diagnostic testing methods, which prove to be, in most instances, more sensitive than conventional culture methods for the isolation of *Bartonella* species.^{13,15,26,30,33,38,41,46,49} Primary isolation of *Bartonella* species following lysis centrifugation or freezing of a blood sample followed by application to a blood agar plate is the most widely used method for the microbiological diagnosis of bartonellosis. Isolation of *Bartonella* species on a blood agar plate generally requires a prolonged incubation period (an average of 21 days) and is rarely successful, unless the patient or animal is infected with a retrovirus, is receiving immunosuppressive drug therapy, or the animal is a reservoir host for the given *Bartonella* species. To date, alternative methods of isolation have not proven to be of

significant diagnostic utility and no suitable liquid medium that will support the growth of all or most medically important *Bartonella* species has been described. Previous reports have described the growth of only one or a few *Bartonella* species, or have isolated *Bartonella* species only from experimentally infected animals.^{13,18,33}

In this report, we describe a novel, liquid culture medium that will support the growth of at least seven *Bartonella* species. This medium will also support co-cultures of different *Bartonella* species, and may also facilitate the primary isolation of *B. henselae* from the blood and aqueous fluid of naturally infected cats.

Materials and methods

Bacterial strains, growth conditions, and chemicals. *Bartonella clarridgeiae* (ATCC700095), *B. doshiae* (ATCC700133), *B. elizabethae* (ATCC49927), *B. grahamii* (ATCC700132), *B. henselae* Houston-1 (ATCC 49882), *B. quintana* Fuller (ATCC VR-358), and *B. vinsonii* (*berkhoffii*) (ATCC 51672) were used for media development and characterization. Liquid and solid cultures of *Bartonella* species were performed at 35°C in a 5% CO₂, water-saturated atmosphere. Liquid cultures were maintained with a constant shaking motion for seven to twelve days. Colony forming unit counts (CFU) in liquid cultures were determined at 24-hours intervals after plating 100 µl aliquots onto commercialized blood agar plates. Blood agar plates were then incubated at 35°C in a 5%

CO₂, water-saturated atmosphere for seven days before CFU enumeration. All chemicals and reagents were purchased from Sigma Chemicals (St. Louis, MO) unless stated otherwise.

Growth medium. The liquid growing media described in this work (hereafter referred to as *Bartonella*-*Alpha* *Proteobacteria* Growth Media, BAPGM) was formulated based upon the biochemical composition of the insect growth media DS2® from Mediatech® (Herndon, VA). BAPGM was formulated to create an efficient growth medium for all of the *Bartonella* species described above. BAPGM was prepared by supplementing 900 ml of DS2® media as follows: 0.1 mg of NAD, 1.25 mg of NADP, 2 mg of ATP, 2 mg of sodium pyruvate, and 2 g of yeast extract. Amino acid supplementation was accomplished by adding: 63.2 mg of L-arginine.HCl, 15.6 mg of L-cystine.HCl, 20.95 mg of L-histidine, 26.25 mg of each L-isoleucine and L-leucine, 36.25 mg of L-lysine, 7.5 mg L-methionine, 16.25 mg of L-phenylalanine, 23.8 mg of L-threonine, 5 mg of L-tryptophan, 21.6 mg of L-tyrosine.2Na.2H₂O, and 23.4 mg of L-valine. The pH of the BAPGM was adjusted to 7.4 with the addition of 50 ml of 0.1 M phosphate buffer and was subsequently sterilized by filtration through a 0.2-µm pore-size filter (Corning®, Corning, NY). After filtration, BAPGM was supplemented with 50 ml of defibrinated sheep blood (to a final 5% v/v).

Growth experiments: Single and multiple *Bartonella* species. In order to establish the growth promoting characteristics of the medium, single as well as

polymicrobial (two different species) *Bartonella* species were inoculated into BAPGM, after which the cultures were maintained at 35°C in a 5% CO₂, water-saturated atmosphere. Single *Bartonella* species colonies were swabbed from the surface of 5- to 7-day-old blood agar plate subcultures and were resuspended in sucrose-phosphate-glutamate (SPG) buffer. A SPG suspension aliquot of 100 µl of *B. henselae* and *B. quintana* (for quantitative growth characterization), and of *B. clarridgeiae*, *B. elizabethae*, *B. grahamii*, *B. vinsonii* (*berkhoffii*), and *B. doshiae* (for qualitative growth characterization) was inoculated into individual flasks containing 10 ml of BAPGM and cultured at 35°C. The growth of each liquid culture group was monitored for seven to twelve days by inoculating 100 µl onto blood agar plates every 24 hours for colonies quantification and by conventional polymerase chain reaction (PCR).

Co-culture experiments were conducted by inoculating approximately 2 to 3 x 10⁴ CFU (inoculum was subsequently determined by blood agar plate colony counts) of *B. henselae* and *B. quintana*, *B. henselae* and *B. vinsonii* (*berkhoffii*), and *B. quintana* and *B. vinsonii* (*berkhoffii*) into 10 ml of BAPGM. The growth of each liquid co-culture was monitored by PCR testing at 3, 5, and 7 days following inoculation.

Naturally infected cat samples. Blood and/or aqueous fluid were submitted for diagnostic evaluation from two different cats (cat A and cat B). A 300-µl aliquot of EDTA-anticoagulated blood was submitted from cat A, which had a <1:16 antibody titer to *B. henselae* by indirect immunofluorescent antibody (IFA) testing conducted in our

laboratory. Cat A was tested because the cat resides in the same household as a dog that was real-time PCR positive for *B. henselae* DNA and had consistently elevated *B. henselae* IFA titers (1:64 and 1:128) over a 6-month period. Additionally, 300 μ l of EDTA-blood and 100 μ l of aqueous fluid from cat B were submitted because of severe uveitis; cat B had a *B. henselae* antibody titer of 1:256 and *B. henselae* DNA was detected in both the blood and aqueous fluid by conventional and real-time PCR. An aliquot of 150 μ l of each of the two EDTA-blood samples and 300 μ l of a 1:5 dilution in SPG buffer of the aqueous fluid sample from cat B were inoculated into 5 ml of BAPGM and cultured as described above for seven days. Growth and colony formation in liquid cultures were determined by plating 100 μ l aliquots onto commercialized blood agar plates and incubated at 35°C in a 5% CO₂, water-saturated atmosphere for seven days. Colonies observed on the blood agar plates were subsequently isolated for characterization by species-specific conventional PCR. The remaining 150 μ l aliquots of each of the two EDTA-blood samples and the 200 μ l of the 1:5 dilution of cat B aqueous fluid sample were inoculated onto commercialized blood agar plates and incubated at 35°C in a 5% CO₂, water-saturated atmosphere for five weeks.

DNA extraction and PCR screening of bacteria cultures. Screening of each *Bartonella* species in liquid and solid media from single organism cultures, co-cultures, and from isolates of the two naturally infected cats was performed by conventional PCR. DNA was prepared from 200 μ l of each liquid culture, or from a resuspension (in Tris-EDTA buffer) of several colonies from the blood agar plate isolates using the QIAamp®

DNA Mini Kit (QIAGEN Inc., Valencia, CA). After extraction, DNA concentration and purity were measured using an absorbance ratio between 260/280 nm.

Conventional PCR analysis. PCR species screening was performed using primers designed to amplify a consensus sequence in the *Bartonella* intergenic transcribed sequence (ITS) region. Amplicon size of this region is species dependent, with sizes ranging from 453 bp for *B. bovis* to 717 bp for *B. elizabethae*.³⁴ Oligonucleotides 321s: 5' AGA TGA TGA TCC CAA GCC TTC TGG 3' and 983as: 5' TGT TCT YAC AAC AAT GAT GAT G 3' were used as forward and reverse primers, respectively. Amplification of the ITS region was performed in a 25- μ l final volume reaction containing 16.5 μ l of molecular grade water (Epicentre®), 0.5 μ l of 10 mM dNTP mixture, 2.5 μ l of 10x PCR reaction buffer, 2.5 μ l of 25mM MgCl₂, and 0.7 units of Amplitaq® Gold DNA polymerase; all reagents were purchased from PE Applied Biosystems® (Foster City, CA) unless otherwise stated. The reaction mixture was completed by adding 0.25 μ l of 30 μ M of each forward and reverse primer (IDT® DNA Technology) and 2 μ l of DNA from each *Bartonella* species tested. PCR negative controls consisted of 2 μ l of dH₂O (when testing isolates from plates) or 2 μ l of DNA extracted from uninoculated BAPGM (when testing BAPGM cultures). Conventional PCR conditions were as follows: a single hot-start cycle at 95°C for 5 minutes followed by 45 cycles of denaturing at 94°C for 45 seconds, annealing at 54°C for 45 seconds, and extension at 72°C for 45 seconds. Amplification was completed by an additional cycle at 72°C for 10 minutes, and products were analyzed

by 2% agarose gel electrophoresis and detection using ethidium bromide under ultraviolet light.

Real-time PCR analysis. Scorpion 321 fluorescent probe 5' FAM-CCG CGT TTT TCA AAG CCC ACG CGG-QUE-HEG-AGA TGA TGA TCC CAA GCC TTC TGG 3' and primer 425as 5' GGA TRA AYY RGW AAA CCT TYM YCG G 3' were used for PCR genus screening of the *Bartonella* ITS region. *Bartonella henselae* species identification was performed by real-time PCR using Taqman® fluorescent probe Cy5 - CCA CCG TGG GCT TTG AAA AAC GCT - DBHQ3, and oligonucleotides 321s 5' AGA TGA TGA TCC CAA GCC TTC TGG CG 3' and 421as 5' GGA TRA AYY RGW AAA CCT TYM YCG G 3' as forward and reverse primers (IDT® DNA Technology), respectively. Real-time reactions were performed using a SmartCycler II System (Cepheid®, Sunnyvale, CA) in 25-µl final volume reactions containing 14.5 µl of molecular grade water (Epicentre®), 5 µl Takara® PCR Master Mix, and 2 µl of 25 mM MgCl₂; all reagents were purchased from Fisher Scientific (Pittsburgh, PA) unless otherwise stated. As above, 2 µl of DNA from each sample were used for real-time PCR analysis. Reactions were completed by adding 1 µl of 10 µM of Scorpion 321 fluorescent probe and 0.25 µl of 30 µM of primer 425as (for genus diagnostic), or 1 µl of 10 µM of Taqman® probe and 0.25 µl of 30 µM of each 321s and 425as primer (for species identification). Real-time PCR conditions were as follows: a single hot-start cycle at 95°C for 30 seconds followed by 45 cycles of denaturing at 94°C for 10 seconds, 6 seconds of annealing temperature at 58°C (for *Bartonella* genus diagnostic) or 54°C (for *B. henselae*

diagnostic), and final extension at 72°C for 10 seconds. Positive amplicons were detected by fluorescence reading at the appropriate wavelength.

Results

Growth of *Bartonella* cultures. The changes in colony forming units following culture of *B. henselae* and *B. quintana* in BAPGM for seven days resulted in growth curves with the typical three phases of bacterial cell growth: the lag phase, the logarithmic growth phase, and the stationary or death phase. The growth of *B. henselae* (Figure 1) in BAPGM was characterized by a 72-hour lag phase, with initial colony counts of approximately 5×10^4 CFU/ml (standard deviation = 1×10^4), followed by a reduction to 1.6×10^4 CFU/ml (SD = 5×10^3) 24 hours later. After a 96-hour incubation in BAPGM a logarithmic growth was observed with a maximum CFU/ml of 5.4×10^7 (SD = 8×10^6) at 272 hours. The growth rate under these culture conditions revealed a 24-hour division time for *B. henselae*. After reaching the maximum growth at 272 hours, a rapid decrease in the *B. henselae* CFU/ml was observed, with no apparent steady-state stationary phase.

Pure cultures of *B. quintana* had a lag phase of 24 to 48 hours (Figure 2), with an initial CFU/ml of approximately 3.3×10^6 (SD = 3×10^5). This phase was followed by a logarithmic growth phase that reached a maximum of 5.2×10^8 CFU/ml (SD = 2×10^7) at 120 hours post inoculation. The growth rate under these culture conditions revealed a 24-

hour division time. Similar to *B. henselae*, a rapid decrease in CFU/ml was observed in *B. quintana*, with no plateau observed during stationary phase.

Likewise, the maximum onset of bacterial growth in BAPGM for *B. clarridgeiae*, *B. elizabethae*, *B. grahamii*, *B. vinsonii (berkhoffii)*, and *B. doshiae* cultures (as observed by blood agar plating) averaged seven to ten days post inoculation (results not shown). As with *B. henselae* and *B. quintana*, PCR screening for *Bartonella* ITS region on all BAPGM cultures at seven days after inoculation resulted in bands of the appropriate size (i.e., matching each cultured species) by gel electrophoresis (Figure 3).

Co-culture of *Bartonella* species. In all co-culture experiments, BAPGM supported the growth of each species and their respective identity was confirmed by conventional PCR screening of the ITS region. Initial PCR screening of 24-hour co-culture samples showed slight bands corresponding to each *Bartonella* species' ITS amplicon size (results not shown). PCR results obtained from co-culture samples at 5 days post-inoculation (Figure 3) showed stronger PCR bands matching each species inoculated into the respective culture: a band at 648 bp and at 564 bp for co-culture of *B. henselae* and *B. quintana*, respectively (Figure 3, Lane 13); a band at 648 bp and at 706 bp for co-culture of *B. henselae* and *B. vinsonii (berkhoffii)*, respectively (Figure 3, Lane 14); and a band at 706 bp and at 564 bp for co-culture of *B. vinsonii (berkhoffii)* and *B. quintana*, respectively (Figure 3, Lane 15). Band intensities for each species inoculated as co-cultures at 5 days post-inoculation matched the bands for each single species that was inoculated and

examined under the same culture conditions (Figure 3, Lanes 10 to 12). However, at seven days post-inoculation, the *B. vinsonii* (*berkhoffii*) band disappeared from both the *B. henselae*-*B. vinsonii* (*berkhoffii*) and *B. quintana*-*B. vinsonii* (*berkhoffii*) co-cultures, but not from the liquid cultures containing *B. vinsonii* (*berkhoffii*) as a single culture species (results not shown). No such effect was observed in the *B. henselae* and *B. quintana* co-culture, in which the 648 bp and 564 bp bands remained clearly visible for up to 10 days.

Isolation *B. henselae* from naturally infected cats. No growth was observed from the two blood samples or from the aqueous fluid sample after direct inoculation onto a blood agar plate and following the cultures visually for five weeks. Culture of the blood sample from cat A and the aqueous fluid from cat B into BAPGM for seven days followed by subculturing onto a blood agar plate produced colonies that were clearly visible on the blood agar plate after seven days. Three colonies were obtained from the cat A blood sample and several colonies were obtained from the aqueous fluid sample (cat B). Each colony was subcultured on blood agar plates for species identification. Samples obtained directly from BAPGM after three and seven days, as well as from each blood agar plate isolate were screened by conventional PCR. For all the samples, PCR followed by gel electrophoresis resulted in a 648 bp single band amplicon that corresponds to the ITS region amplicon of *B. henselae*. Further, this finding was confirmed by real-time PCR using a *B. henselae*-specific Taqman® fluorescent probe. Although no colony formation was observed following subculture of the cat B blood sample, real-time PCR analyses using DNA extracted from whole blood and from BAPGM blood culture were both

positive using *Bartonella* genera- and *B. henselae*-specific probes. It is interesting to note that *B. henselae* in the blood and aqueous fluid samples from cat B by real-time PCR showed a much lower DNA copy number in the blood and in the blood-BAPGM culture as compared to the aqueous fluid and the aqueous fluid-BAPGM culture (results not shown). Successful isolation of *B. henselae* from the aqueous fluid from cat B may have resulted due to the larger number of bacteria present in this sample, when compared with the number of organisms present in blood.

Discussion

As is true for many fastidious pathogens, difficulties associated with *Bartonella* isolation have compromised efforts to define the role of these organisms in disease causation. Isolation of the infecting bacteria aids in the evaluation of more sensitive and improved diagnostic assays, and advances the understanding of the diversity, adaptation, and epidemiology of this genera.³³ It is the opinion of the authors that chronic infection with *Bartonella* species can contribute to very subtle clinical abnormalities or vague symptoms in companion animals or in human patients, respectively. Despite advances in PCR, improved culture methods are needed for the isolation of *Bartonella* species. Culture media used for *Bartonella* species isolation in clinical laboratories have questionable sensitivity and many laboratories continue to rely on standard blood agar plate cultures (5% rabbit blood heart infusion-trypticase agar or chocolate agar).^{10,13,33}

Several laboratories have participated in research efforts, with a goal of creating an isolation medium that will enhance the growth and maintenance of *Bartonella* species. Despite these efforts, the isolation of *Bartonella* species from non-immunocompromised individuals remains a highly insensitive diagnostic method. This finding suggests that additional optimization of the biochemical constituents of a liquid media is required to attain isolates from patients. To date, no liquid or solid phase media has proven to be reliable for the isolation of single or multiple *Bartonella* species from naturally infected animals or humans.^{3,13} Although some blood-free media have shown good potential for the growth of *B. henselae* or *B. quintana*,^{13,49} supplementation of blood, erythrocyte membranes, or an erythrocyte membrane component seems to be required for the initial growth and to achieve the full growth-promoting effect of the culture medium.^{33,46} In addition, the use of hemin as a blood or erythrocyte substitute represents a real challenge, which could compromise the use of these media when the infecting *Bartonella* species is not known or when polymicrobial *Bartonella* infection is present in the patient. Research has shown that optimal hemin concentration differs among *Bartonella* species.⁴⁶ *Bartonella quintana* required a hemin concentration of 40 µg/ml for growth, while *B. henselae* required approximately 250 µg/ml of hemin for ideal growth. In fact, hemin concentrations in excess of these established for optimal growth became toxic to each *Bartonella* species tested, resulting in decreased growth (i.e., ideal hemin concentrations for the growth of *B. henselae* are toxic to *B. quintana*).⁴⁶ It should be noted that only *B. henselae* (from culture and clinical samples) and *B. quintana* (from culture samples) have been evaluated in order to establish the isolation and growth support/enhancement

potential role of blood-free media.^{13,46,49} Also, the development of optimal culture techniques and improvements in isolation media may have been hampered somewhat as only a few (primarily *B. henselae* and *B. quintana*) of the 17 *Bartonella* species described to date have been biochemically characterized.

In this study, we describe the development of a novel, liquid isolation medium, which is based on a formulation that promotes the growth of insect cells in culture. This medium supports the isolation and growth of at least seven *Bartonella* species and may facilitate the isolation of two or more *Bartonella* species from the same patient. Co-infection, as indicated by serology and/or PCR, with more than one *Bartonella* species has been frequently reported in dogs and cats,^{19,20,36,47} and has been suggested to occur in rodents.^{32,50} It is the opinion of the authors that the occurrence of co-infection with multiple *Bartonella* species is likely underestimated in both animals and humans due to the limitations associated with the culture and isolation of the infecting agent and the limitations associated with other diagnostic methodologies currently in use (e.g., PCR and serology). It is not clear if the disappearance of the 706 bp band of *B. vinsonii* (*berkhoffii*) during co-culture conditions with *B. henselae* or *B. quintana* was a consequence of the death of this species as a result of competition, the production of toxic metabolite(s) by *B. henselae* and *B. quintana*, or a deleterious effect of phage induction.^{1,4,13,35} If these *in vitro* data are applicable to *in vivo* competition among *Bartonella* species within animals or human beings, it would suggest that one *Bartonella* species could substantially suppress another *Bartonella* species making detection by culture or PCR very difficult. In the

current study, BAPGM supported the primary isolation of *B. henselae* from two clinical samples (blood and aqueous fluid) in half the time generally required when using a conventional isolation media (e.g., sheep blood agar plate or chocolate agar plate). Isolates were not obtained from these two clinical samples by direct inoculation onto a blood agar plate, which is consistent with the limited sensitivity of the conventional isolation approach for the detection of *B. henselae* and other *Bartonella* species. Recently, we have used the isolation approach described in this study to obtain *Bartonella* spp. isolates from dogs and human beings with chronic illnesses.

The results of this study suggest that the use of BAPGM for the detection and isolation of *Bartonella* species may provide an improved or alternative method to isolate these fastidious microorganisms from patient samples. In the future, BAPGM may represent an important culture option for the clinical microbiology laboratory. In an effort to optimize the utility of this medium, we are currently evaluating the effectiveness of different amino acid combinations in BAPGM. Amino acid supplementation appears to be one of the key components required to improve and enhance *Bartonella* species growth.¹³ In addition, we are further evaluating the diagnostic utility of BAPGM for the improved isolation of *Bartonella* species from sick animals and humans.

References

1. **Anderson, B. E., C. Goldsmith, A. Johnson, I. Padmalayam, and B. Baumstark.** 1994. Bacteriophage-like particles of *Rochalimaea henselae*. *Mol. Microbiol.* **13**:67-73.
2. **Anderson, B. and M. A. Neuman.** 1997. *Bartonella* spp. as emerging human pathogens. *Clin. Microbiol. Rev.* **10**:203-219.
3. **Avidor, B.** 2004. *Bartonella koehlera*, a new human pathogen causing culture-negative endocarditis. The 4th International Conference on *Bartonella* as Emerging Pathogens, Uppsala, Sweden.
4. **Barksdale, L. and S. B. Arden.** 1974. Persisting bacteriophage infections, lysogeny, and phage conversions. *Rev. Microbiol.* **28**:265-299.
5. **Bergmans, A. M. C., J. F. P. Schellekens, J. D. A. Van Embden, and L. M. Schouls.** 1996. Predominance of two *Bartonella* variants among cat scratch disease patients in The Netherlands. *J. Clin. Microbiol.* **34**:254-260.
6. **Birtles, R. J., J. Canales, P. Ventosilla, E. Alvarez, H. Guerra, A. Llanos-Cuentas, D. Raoult, N. Doshi, and T. G. Harrison.** 1999. Survey of *Bartonella* species infecting intradomicillary animals in the Huayllacallan Valley, Ancash, Peru, a region endemic for human bartonellosis. *Am. J. Trop. Med. Hyg.* **60**:799-805.
7. **Breitschwerdt, E. B., C. E. Atkins, T. T. Brown, D. L. Kordick, and P. S. Snyder.** 1999. *Bartonella vinsonii* subsp. *berkhoffi* and related members of the alpha

- subdivision of the *Proteobacteria* in dogs with cardiac arrhythmias, endocarditis, or myocarditis. J. Clin. Microbiol. **37**:3618-3626.
8. **Breitschwerdt, E. B. and D. L. Kordick.** 2000. *Bartonella* infection in animals: carriership, reservoir potential, pathogenicity, and zoonotic potential for human infection. Clin. Microbiol. Rev. **13**:428-438.
 9. **Breitschwerdt, E. B., D. L. Kordick, and D. E. Malarkey.** 1995. Endocarditis in a dog due to infection with a novel *Bartonella* subspecies. J. Clin. Microbiol. **33**:154-160.
 10. **Brenner, S. A., J. A. Rooney, P. Manzewitsch, and R. L. Regnery.** 1997. Isolation of *Bartonella (Rochalimaea) henselae*: effects of methods of blood collection and handling. J. Clin. Microbiol. **35**:544-547.
 11. **Brouqui, P., B. La Scola, V. Roux, and D. Raoult.** 1999. Chronic *Bartonella quintana* bacteremia in homeless patients. N. Engl. J. Med. **340**:184-189.
 12. **Chang, C. C., B. B. Chomel, R. W. Kasten, R. Heller, K. M. Kocan, H. Ueno, K. Yamamoto, V. C. Bleich, B. M. Pierce, B. J. Gonzales, P. K. Swift, W. M. Boyce, S. S. Jang, H. J. Boulouis, and Y. Piémont.** 2000. *Bartonella* spp. isolated from wild and domestic ruminants in North America. Emerg. Infect. Dis. **6**:306-311.
 13. **Chenoweth, M. R., G. A. Somerville, D. C. Krause, K. L. O'Reilly, and F. C. Gherardini.** 2004. Growth characteristics of *Bartonella henselae* in a novel liquid medium: primary isolation, growth-phase dependent phage induction, and metabolic studies. App. Env. Microbiol. **70**:656-663.

14. **Clarridge, J. E., T. J. Raich, D. Pirwani, B. Simon, L. Tsai, M. C. Rodriguez-Barradas, R. L. Regnery, A. Zollo, D. C. Jones, and C. Rambo.** 1995. Strategy to detect and identify *Bartonella* species in routine laboratory yields *Bartonella henselae* from human immunodeficiency virus-positive patient and unique *Bartonella* strain from his cat. *J. Clin. Microbiol.* **33**:2107-2113.
15. **Cunningham, E. T. and J. E. Koehler.** 2000. Ocular Bartonellosis. *Am. J. Ophthalmol.* **130**:340-349.
16. **Daly, J. S., M. G. Worthington, D. J. Brenner, C. W. Moss, D. G. Hollis, and R. S. Weyant.** 1993. *Rochalimaea elizabethae* sp. nov. isolated from a patient with endocarditis. *J. Clin. Microbiol.* **31**:872-881.
17. **Drancourt, M., R. Birtles, G. Chaumentin, F. Vandenesch, J. Etienne, and D. Raoult.** 1996. New serotype of *Bartonella henselae* in endocarditis and cat-scratch disease. *Lancet.* **347**:441-443.
18. **Fournier, P. E., J. Robson, Z. Zeaiter, R. McDougall, S. Byrne, and D. Raoult.** 2002. Improved culture from lymph nodes of patients with cat scratch disease and genotypic characterization of *Bartonella henselae* isolates in Australia. *J. Clin. Microbiol.* **40**:3620-3624.
19. **Gurfield, A. N., H. J. Boulouis, B. B. Chomel, R. Heller, R. W. Kasten, K. Yamamoto, and Y. Piemont.** 1997. Coinfection with *Bartonella clarridgeiae* and *Bartonella henselae* and with different *Bartonella henselae* strains in domestic cats. *J. Clin. Microbiol.* **35**:2120-2123.

20. **Gurfield, A. N., H. J. Boulouis, B. B. Chomel, R. W. Kasten, R. Heller, C. Bouillin, C. Gandoin, D. Thibault, C. C. Chang, F. Barrat, and Y. Piemont.** 2001. Epidemiology of *Bartonella* infection in domestic cats in France. *Vet. Microbiol.* **80**:185-198.
21. **Hadfield, T. L., R. Warren, M. Kass, E. Brun, and C. Levy.** 1993. Endocarditis caused by *Rochalimaea henselae*. *Hum. Pathol.* **24**:1140-1141.
22. **Houpikian, P., and D. Raoult.** 2001. 16S/23S rRNA intergenic spacer regions for phylogenetic analysis, identification, and subtyping of *Bartonella* species. *J. Clin. Microbiol.* **39**:2768-2778.
23. **Jacomo, V., P. J. Kelly, and D. Raoult.** 2002. Natural history of *Bartonella* infections (an exception to Koch's postulate). *Clin. Diagn. Lab. Immunol.* **9**:8-18.
24. **Jensen, W. A., M. Z. Fall, J. Rooney, D. L. Kordick, and E. B. Breitschwerdt.** 2000. Rapid identification and differentiation of *Bartonella* species using a single-step PCR assay. *J. Clin. Microbiol.* **38**:1717-1722.
25. **Joblet, C., V. Roux, M. Drancourt, J. Gouvernet, and D. Raoult.** 1995. Identification of *Bartonella* (*Rochalimaea*) species among fastidious gram-negative bacteria on the basis of the partial sequence of the citrate-synthase gene. *J. Clin. Microbiol.* **33**:1879-1883.
26. **Johnson, G., M. Ayers, S. C. McClure, S. E. Richardson, and R. Tellier.** 2003. Detection and identification of *Bartonella* species pathogenic for humans by PCR amplification targeting the riboflavin synthase gene (ribC). *J. Clin. Microbiol.* **41**:1069-1072.

27. **Karem, K. L., C. D. Paddock, and R. L. Regnery.** 2000. *Bartonella henselae*, *B. quintana*, and *B. bacilliformis*: Historical pathogens of emerging significance. *Microbes. Infect.* **2**:1193-1205.
28. **Kerkhoff, F. T., A. M. Bergmans, A. van Der Zee, and A. Rothova.** 1999. Demonstration of *Bartonella grahamii* DNA in ocular fluids of a patient with neuroretinitis. *J. Clin. Microbiol.* **37**:4034-4038.
29. **Koehler, J. E.** Clinical manifestation of *Bartonella* infections. 2004. The 4th International Conference on *Bartonella* as Emerging Pathogens, Uppsala, Sweden.
30. **Koehler, J. E., F. D. Quinn, T. G. Berger, P. E. LeBoit, and J. W. Tappero.** 1992. Isolation of *Rochalimaea* species from cutaneous and osseous lesions of bacillary angiomatosis. *N. Engl. J. Med.* **327**:1625-1631.
31. **Kordick, D. L., E. J. Hilyard, T. L. Hadfield, K. H. Wilson, A. G. Steigerwalt, D. J. Brenner, and E. B. Breitschwerdt.** 1997. *Bartonella clarridgeiae*, a newly recognized zoonotic pathogen causing inoculation papules, fever, and lymphadenopathy (Cat Scratch Disease). *J. Clin. Microbiol.* **35**:1813-1818.
32. **Kosoy, M. Y., R. L. Regnery, T. Tzianabos, E. L. Marston, D. C. Jones, D. Green, G. O. Maupin, J. G. Olson, and J. E. Childs.** 1997. Distribution, diversity, and host specificity of *Bartonella* in rodents from the Southeastern United States. *Am. J. Trop. Med. Hyg.* **57**:578-588.
33. **LaScola, B. and D. Raoult.** 1999. Culture of *Bartonella quintana* and *Bartonella henselae* from human samples: a 5-year experience (1993-1998). *J. Clin. Microbiol.* **37**:1899-1905.

34. **Maggi, R. G. and E. B. Breitschwerdt.** 2004. *Bartonella* 16S-23S rRNA intergenic region: The whole ITS region is not suitable for *Bartonella* detection and subtyping. J. Clin. Microbiol. Second Review.
35. **Maggi, R. G. and E. B. Breitschwerdt.** 2004. Bacteriophage in *Bartonella vinsonii berkhoffii* and characterization of its Pap 31 Gene. The 4th International Conference on *Bartonella* as Emerging Pathogens, Uppsala, Sweden.
36. **Maruyama, S., T. Sakai, Y. Morita, S. Tanaka, H. Kabeya, S. Boonmar, A. Poapolathep, T. Chalermchaikit, C. C. Chang, R. W. Kasten, B. B. Chomel, and Y. Katsube.** 2001. Prevalence of *Bartonella* species and 16s rRNA gene types of *Bartonella henselae* from domestic cats in Thailand. Am. J. Trop. Med. Hyg. **65**:783-787.
37. **Maurin, M., R. Birtles, and D. Raoult.** 1997. Current knowledge of *Bartonella* species. Eur. J. Clin. Microbiol. Infect. Dis. **16**:487-506.
38. **Pitulle, C., C. Strehse, J. W. Brown, and E. B. Breitschwerdt.** 2002. Investigation of the phylogenetic relationships within the genus *Bartonella* based on comparative sequence analysis of the rnpB gene, 16S rDNA, and 23S rDNA. Intern. J. Syst. Evol. Microbiol. **52**:2075-2080.
39. **Raoult, D.** 1995. *Bartonella (Rochalimaea) quintana* endocarditis in three homeless men. N. Engl. J. Med. **332**:419-423.
40. **Raoult, D., M. Drancourt, A. Carta, and J. A. Gastaut.** 1994. *Bartonella (Rochalimaea) quintana* isolation in a patient with chronic adenopathy, lymphopenia, and a cat. Lancet. **343**:977.

41. **Raoult, D., G. Greub, P. E. Fournier, and Z. Zeaiter.** 2003. Diagnosis of *Bartonella* endocarditis by Real-Time Nested PCR assay using serum. *J. Clin. Microbiol.* **41**:919-925.
42. **Regnery, R. L., B. E. Anderson, J. E. Clarridge III, M. Rodriguez-Barradas, D. C. Jones, and J. H. Carr.** 1992. Characterization of a novel *Rochalimaea* species, *R. henselae* sp. nov., isolated from blood of a febrile human immunodeficiency virus-positive patient. *J. Clin. Microbiol.* **30**:265-274.
43. **Relman, D. A.** 1995. Has Trench Fever Returned? *N. Engl. J. Med.* **332**:463-464.
44. **Schattner, A., O. Zimhony, B. Avidor, and M. Giladi.** 2003. Asking the right question. *Lancet.* **361**:1786.
45. **Schwartzman, W.** 1996. *Bartonella (Rochalimaea)* infections: beyond cat scratch. *Annu. Rev. Med.* **47**:355-364.
46. **Schwartzman, W. A., C. A. Nesbit, and E. J. Baron.** 1993. Development and evaluation of a blood-free medium for determining growth curves and optimizing growth of *Rochalimaea henselae*. *J. Clin. Microbiol.* **31**:1882-1885.
47. **Solano-Gallego, L., J. Bradley, B. Hegarty, B. Sigmon, and E. Breitschwerdt.** 2004. *Bartonella henselae* IgG antibodies are prevalent in dogs from southeastern USA. *Vet Res.* **35**:585-595.
48. **Welch, D. F., D. A. Pickett., L. N. Slater, A. G. Steigerwalt, and D. J. Brenner.** 1992. *Rochalimaea henselae* sp. nov., a cause of septicemia, bacillary angiomatosis, and parenchymal bacillary peliosis. *J. Clin. Microbiol.* **30**:275-280.

49. **Wong, M. T., M. J. Dolan, C. P. Lattuada, R. L. Regenry, M. L. Garcia, and E. C. Mokulis.** 1995. Neuroretinitis, aseptic meningitis, and lymphadenitis associated with *Bartonella henselae* infection in immunocompetent patients and patients infected with human immunodeficiency virus type I. *Clin. Infect. Dis.* **21**:352-360.
50. **Ying, B., M. Y. Kosoy, G. O. Maupin, K. R. Tsuchiya, and K. L. Gage.** 2002. Genetic and ecologic characteristics of *Bartonella* communities in rodents in southern China. *Am. J. Trop. Med. Hyg.* **66**:622-627.

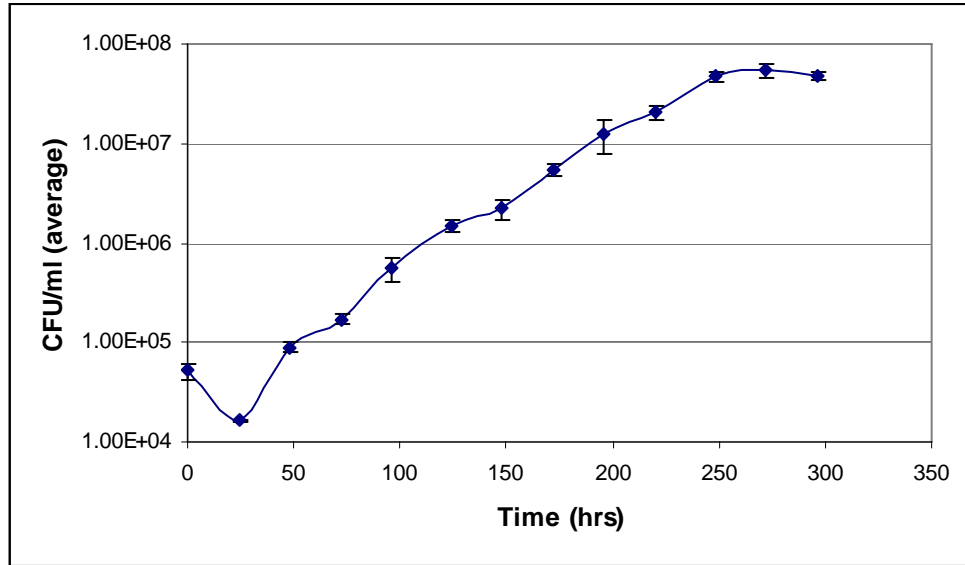

Figure 1. Growth curve of *B. henselae* in BAPGM. Viable cell counts (reported as CFU/ml) in BAPGM liquid medium were determined at 24-hour intervals after plating individual culture aliquots onto commercial blood agar plates. Colony counts were performed after a 7-day incubation period on blood agar plates that were maintained at 35°C and 5% CO₂ in a water-saturated atmosphere.

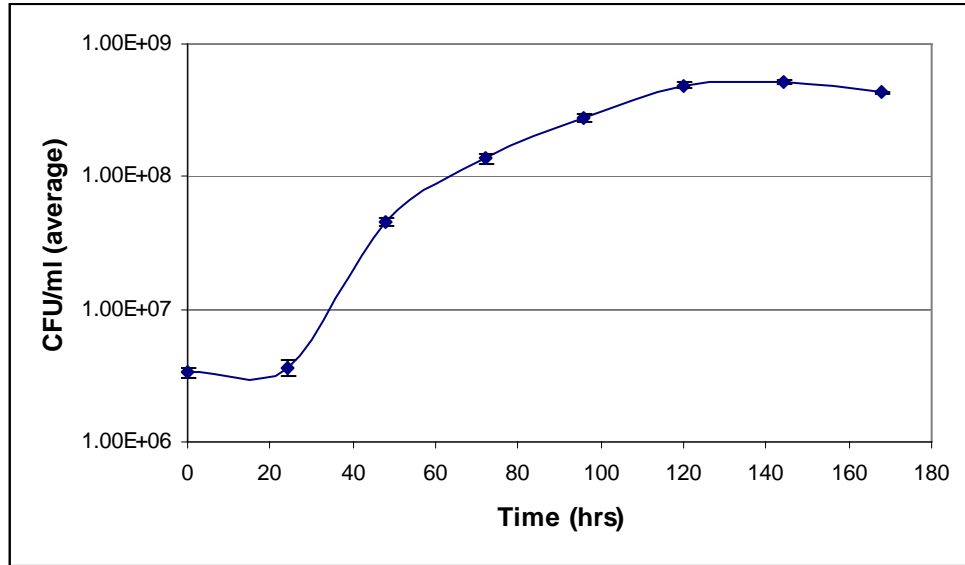

Figure 2. Growth curve of *B. quintana* in BAPGM. Viable cell counts (reported as CFU/ml) in liquid BAPGM were determined at 24-hour intervals after plating of individual culture aliquots onto commercial blood agar plates. Colony counts were performed after a 7-day incubation period on blood agar plates that were maintained at 35°C and 5% CO₂ in a water-saturated atmosphere.

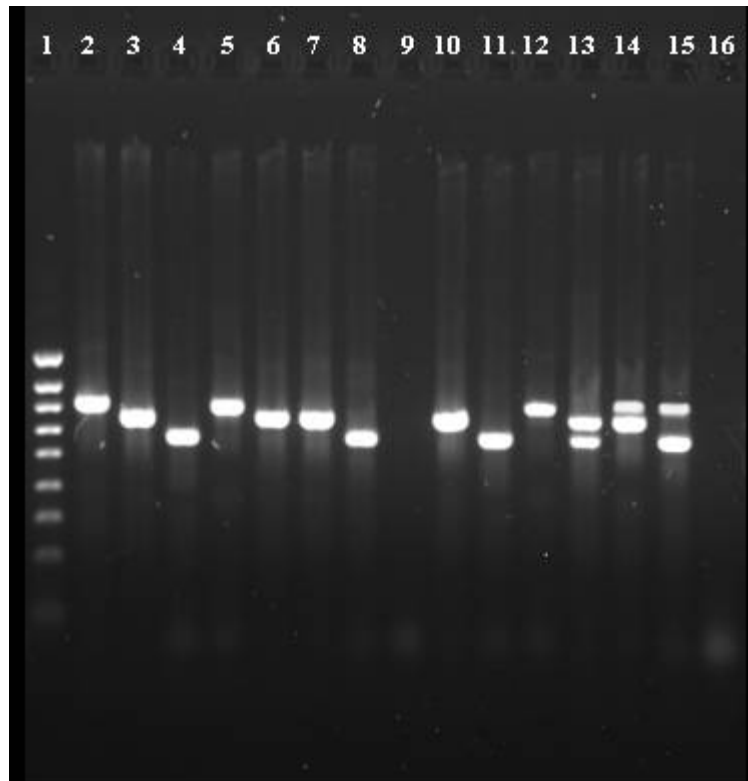

Figure 3. Two percent agarose gel electrophoresis of an intergenic spacer region PCR amplification (primers 321s and 983as) of *Bartonella* cultures in BAPGM (lanes 2 to 9, at 7 days postinoculation; lanes 10 to 16, 5 days postinoculation). Lane 1, 1-kbp DNA ladder; lane 2, *B. elizabethae* (717 bp); lane 3, *B. grahamii* (658 bp); lane 4, *B. quintana* Fuller (564 bp); lanes 5 and 12, *B. vinsonii* (*berkhoffii*) (706 bp); lane 6, *B. henselae* Houston-1 (648 bp); lane 7, *B. clarridgeiae* (636 bp); lane 8, *B. doshiae* (550 bp); lanes 9 and 16, BAPGM as a negative control; lane 10, *B. henselae*; lane 11, *B. quintana*; lane 13, *B. henselae* and *B. quintana* co-culture; lane 14, *B. henselae* and *B. vinsonii* (*berkhoffii*) co-culture; lane 15, *B. quintana* and *B. vinsonii* (*berkhoffii*) co-culture.

Chapter 3. A combined approach for the enhanced detection and isolation of *Bartonella* species in dog blood samples: pre-enrichment liquid culture followed by PCR and subculture onto agar plates

Manuscript as published in the Journal of Microbiological Methods.

Duncan, A.W., Maggi, R.G., Breitschwerdt, E.B., 2007. A combined approach for the enhanced detection and isolation of *Bartonella* species in dog blood samples: Pre-enrichment liquid culture followed by PCR and subculture onto agar plates. J. Microbiol. Methods. 69 (2), 273-281.

A combined approach for the enhanced detection and isolation of *Bartonella* species in dog blood samples: pre-enrichment liquid culture followed by PCR and subculture onto agar plates

Ashlee W. Duncan, Ricardo G. Maggi, and Edward B. Breitschwerdt

Intracellular Pathogens Research Laboratory and the Center for Comparative Medicine and Translational Research, College of Veterinary Medicine, North Carolina State University, Raleigh, North Carolina 27606

Corresponding author: Dr. Edward Breitschwerdt

Edward B. Breitschwerdt

Department of Clinical Sciences

College of Veterinary Medicine

North Carolina State University

4700 Hillsborough Street

Raleigh, NC, 27606

Phone: (919) 513-8277

Fax: (919) 513-6336

E-mail: Ed_Breitschwerdt@ncsu.edu

Keywords: *Bartonella*, culture, detection, dog, isolation

Summary

Historically, direct plating, lysis centrifugation, or freeze-thaw approaches have proven to be highly insensitive methods for confirming *Bartonella* species infection in dogs. A prospective study was designed to compare diagnostic methods for the detection of *Bartonella* using samples submitted to the Vector-Borne Disease Diagnostic Laboratory at North Carolina State University. Methods included indirect immunofluorescence assay, PCR, direct inoculation of a blood agar plate (trypticase soy agar with 5% rabbit blood), and inoculation into a novel pre-enrichment liquid medium, *Bartonella*/ alpha-*Proteobacteria* growth medium (BAPGM). Sequential research efforts resulted in the development of a combinational approach consisting of pre-enrichment culture of *Bartonella* species in BAPGM, sub-inoculation of the liquid culture onto agar plates, followed by DNA amplification using PCR. The multi-faceted approach resulted in substantial improvement in the microbiological detection and isolation of *Bartonella* when compared to direct inoculation of a blood agar plate. Importantly, this approach facilitated the detection and subsequent isolation of both single and co-infections with two *Bartonella* species in the blood of naturally infected dogs. The use of a combinational approach of pre-enrichment culture and PCR may assist in the diagnostic confirmation of bartonellosis in dogs and other animals.

Introduction

Bacteria of the genus *Bartonella* (alpha subdivision of the class *Proteobacteria*) are fastidious, gram-negative, aerobic bacilli with more than 20 described species or subspecies (Boulouis et al., 2005; Chomel et al., 2003; Chomel et al., 2004; Chomel et al., 2006; Clarridge et al., 1995; Houpijian and Raoult, 2001; Joblet et al., 1995; Maurin et al., 1997). As a cause of disease in veterinary and human medicine, *Bartonella* are highly adapted to mammalian reservoir hosts, and within these reservoir hosts, the bacteria usually cause long-lasting intraerythrocytic bacteremia (Dehio 2001; Jacomo et al., 2002; Kordick and Breitschwerdt, 1995; Breitschwerdt and Kordick, 2000). Several *Bartonella* species, including *B. clarridgeiae*, *B. elizabethae*, *B. henselae*, *B. vinsonii* subspecies *berkhoffii*, and *B. washoensis*, infect dogs and may contribute to the pathogenesis of a wide spectrum of disease manifestations, including polyarthritits, cutaneous vasculitis, endocarditis, myocarditis, epistaxis, peliosis hepatis, and granulomatous inflammatory disease (Breitschwerdt et al., 1995; Breitschwerdt et al., 1999; Chomel et al., 2001; Gillespie et al., 2003; Kitchell et al., 2000; Kordick et al., 1997; MacDonald et al., 2004; Mexas et al., 2002; Pappalardo et al., 2000a; Pappalardo et al., 2000b; Pappalardo et al., 2001; Breitschwerdt et al., 2004; Breitschwerdt et al., 2005; Henn et al., 2005; Kordick et al., 1996).

Historically, *Bartonella* have been cultured using direct plating or lysis-centrifugation and freeze-thaw techniques followed by the inoculation of a blood or chocolate agar plate

(Regnery et al., 1992; Welch et al., 1992). Isolation of most *Bartonella* species on a blood agar plate typically requires an extended incubation period (average = 21 days) and is rarely successful in an immunocompetent, non-reservoir host, perhaps due to an extremely low number of circulating *Bartonella* organisms (Gouriet et al., 2005; Rolain et al., 2001; Rolain et al., 2002). To date, alternative methods of isolation have proven to be of limited diagnostic utility; further, no liquid medium that will support the growth of several clinically important *Bartonella* species has been characterized using clinical samples (Chenoweth et al., 2004; Fournier et al., 2002; La Scola et al., 1999).

Recently, our laboratory developed a novel, chemically modified, insect-based liquid culture medium (*Bartonella*/alpha-*Proteobacteria* growth media, BAPGM) that supports the growth of at least seven *Bartonella* species; this medium also supported co-cultures consisting of different *Bartonella* species and facilitated isolation of *B. henselae* from the blood and aqueous fluid of naturally infected cats (Maggi et al., 2005a). Similar to traditional culture methods, BAPGM aided in agar plate isolation of *B. henselae* from cats; however, the successful use of this new liquid medium for the isolation of *Bartonella* from the blood of sick dogs was much more difficult to achieve. In the present study, we describe an improved combinational approach, incorporating minor modifications to our previously reported pre-enrichment medium (Maggi et al., 2005a), which facilitated the molecular detection and isolation of *Bartonella* in blood samples obtained from sick dogs. The purpose of this prospective study was to compare and improve the methods used for the microbiological diagnosis of bartonellosis in the North Carolina State University,

College of Veterinary Medicine, Vector-Borne Disease Diagnostic Laboratory (NCSU-CVM-VBDDL).

Materials and methods

Study design. The NCSU-CVM-VBDDL uses indirect immunofluorescence assays to detect exposure to *Bartonella* species, specifically *B. henselae* and *B. vinsonii (berkhoffii)*. Further, conventional and real-time PCR and microbiological techniques are utilized to detect active infection with *Bartonella* species. In the current work, these methods were evaluated during three distinct and sequential study phases (Figure 1). Sick dogs, meeting the entry criteria, were prospectively entered into each separate phase.

Serological analyses. Indirect immunofluorescence assays (IFA) for *B. henselae* and *B. vinsonii (berkhoffii)* were performed as previously described (Solano-Gallego et al., 2004).

DNA extraction and PCR analyses. DNA extraction and PCR screening for *Bartonella* species from EDTA-anticoagulated blood samples, pre-enriched blood cultures at 7 or 10 days, and from blood agar plate isolates were performed as previously described (Maggi et al., 2005a, Maggi et al., 2005b).

Real-time PCR analysis. Screening for *Bartonella* genus bacteria and the use of multiplex, species-specific, Taqman® fluorescent probes were performed as described previously (Maggi et al., 2005b), although the *B. clarridgeiae* probe was not used during this study. Reaction master mix components and cycling conditions have been described elsewhere (Maggi et al., 2005a, Maggi et al., 2005b). Fifteen (15) microliters of sample template DNA was used for real-time PCR analyses. DNA was extracted from EDTA-anticoagulated blood samples of a clinically healthy dog for use as negative controls; similar DNA aliquots were prepared as previously described for positive controls (Maggi et al., 2005b).

Conventional PCR analysis.

- a) **ITS region:** PCR analyses of *Bartonella* intergenic transcribed spacer (ITS) region were performed as described previously (Maggi et al., 2005b). Master mix components and cycling conditions have been described elsewhere (Maggi et al., 2005a, Maggi et al., 2005b). Five (5) microliters of sample template DNA was used in the current work. Negative controls were prepared as described above for real-time PCR and elsewhere (Maggi et al., 2005a).

- b) **Pap31 amplification:** Amplification of the Pap31 gene was performed as described above for the ITS region and as described elsewhere (Maggi et al., 2005b).

Cloning and sequencing of ITS and Pap31 amplicons. Representative samples were cloned and sequenced to confirm species identification and to establish strain classification, as described previously (Maggi et al., 2005b).

Pre-enrichment culture. Blood samples were cultured using modifications to the previously characterized BAPGM, such as a reduction in pH from 7.4 to 6.2 (Maggi et al., 2005a). Additional, minor modifications were integrated into phase 3, such as a shorter pre-enrichment incubation period and an increase in the final volume of defibrinated sheep blood.

Samples for culture:

Convenience samples of clinical submissions of dog blood and serum, submitted to the NCSU-CVM-VBDDL for IFA serological analysis for *B. henselae* and *B. vinsonii* (*berkhoffii*) antibodies, were prospectively assessed in phases 1 and 2. To allow for PCR and culture, at least 1 mL of EDTA-anticoagulated blood must have been simultaneously submitted with the request for *Bartonella* serologies.

The entire sample population (n = 148) included 66 females (58 spayed, 8 intact) and 74 males (59 neutered, 15 intact); signalment was not provided for the remaining 8 dogs. The age was known for 143 dogs with a mean \pm standard deviation of 6.5 ± 3.0 years (range: 6 months to 14 years). Various breeds were represented and 24 dogs were mixed breed. No differences were noted between the populations enrolled in each phase. Although clinical

and historical abnormalities are not consistently reported with sample submissions, most dogs would be tested for exposure to tick-borne pathogens because of one or more of the following clinical abnormalities: unexplained fever, weight loss, lameness, neurological signs, anemia, thrombocytopenia, hyperproteinemia, and/or protein-losing nephropathy.

Following direct inoculation or sub-inoculation, agar plates were placed in polyethylene plastic bags, were maintained at 35°C, 5% CO₂ in a water-saturated environment, and were examined weekly for colony formation. Colonies, if present, were scraped from plates and resuspended in phosphate buffered saline (PBS) for identification by PCR. For each set of samples, an un-inoculated control liquid culture, as appropriate, and an un-inoculated blood agar plate were processed at the same time and in an identical manner.

Phase 1

Samples (n = 50) were collected from April 23, 2004 to June 3, 2004. After sample receipt, blood samples were frozen (-80°C) in 800 µL aliquots; samples remained frozen until prepared for direct inoculation onto a plate containing Trypticase™ soy agar with 5% rabbit blood (BD, Franklin Lakes, NJ) (Breitschwerdt et al., 1995) . All culture media were allowed to equilibrate to room temperature prior to use. Frozen blood aliquots were quick thawed in a water bath at 37°C. Dulbecco's Modified Eagle's Medium (DMEM) (MediaTech, Inc. Herndon, VA) was supplemented with 10% fetal bovine serum, 1% L-glutamine, 1% sodium pyruvate, and 21% sodium bicarbonate, and was sterilized by

filtration through a 0.2- μm -pore-size filter (Corning, Corning, NY) (Dr. Bruno Chomel and Dr. Jane Koehler, personal communication). Blood aliquots (800 μL) were mixed with 300 μL of supplemented DMEM by vortexing and subsequently transferred to the blood agar plate, which was maintained for 6 weeks.

Phase 2

Samples ($n = 50$) were collected from May 24, 2004 to June 30, 2004. Following sample receipt, blood was frozen to -80°C , prior to the inoculation of modified BAPGM. The liquid medium (5 mL) was aliquoted to a closed system, 25cm^2 cell culture flask with a plug seal cap (Corning®, Corning, NY) and supplemented with defibrinated sheep blood (HemoStat Laboratories, Dixon, CA) to a 5% final volume (Maggi et al., 2005a). Five hundred microliters (500 μL) of the dog blood sample was added to each flask. Liquid cultures were maintained as described elsewhere (Maggi et al., 2005a). After 10 days, a 200- μL aliquot of the liquid medium was removed for DNA extraction and PCR, and an 800- μL aliquot was sub-inoculated onto a blood agar plate, which was maintained for 6 weeks.

Phase 3

Based on previous results, phase 3 included minor refinements to the methods and to the BAPGM as follows: blood samples were stored at 4°C , rather than frozen, for up to 1 week prior to inoculation of the liquid medium; the final volume of defibrinated sheep blood was

increased from 5% to 10%; liquid cultures were maintained for 7 days, rather than 10, prior to plating; and the cap on the cell-culture flasks was changed from a plug-seal to a vented cap to allow for increased gas exchange.

Samples (n = 48) were collected from May 3, 2004 to February 8, 2006. These samples were prospectively assessed and comprised a somewhat more defined, convenience sample of clinical submissions received by NCSU-CVM-VBDDL for diagnostic testing. To be included in phase 3, sufficient sample volumes of serum (1 mL) for conducting *Bartonella* IFA analyses and EDTA-anticoagulated blood (1.2 mL) for PCR analysis and inoculation of the liquid medium must have been submitted. For a subset of these cases, the pre-enrichment culture was recommended to the referring veterinarian by the laboratory director as a potentially more sensitive diagnostic service for the detection of *Bartonella* bacteria in dog blood.

During phase 3, a 1-mL aliquot of dog blood was added to each cell-culture flask and cultures were maintained as described previously (Maggi et al., 2005a). After 7 days, a 200- μ L aliquot of the liquid medium was removed for DNA extraction and PCR; additionally, a 1-mL aliquot was sub-inoculated onto a blood agar plate, which was maintained for 3 weeks.

Results

Phase 1: Serology

Serum *B. henselae* IgG antibodies were detected in 32% (16/50) of the dogs surveyed; the majority had low reciprocal titers of 64 (10/16) or 128 (5/16), with a single *B. henselae* seroreactor at 512. All remaining dogs (34/50) were not seroreactive by *B. henselae* IgG antibodies (titers <1:16). Conversely, serum *B. vinsonii* (*berkhoffii*) IgG antibodies were detected in only 1 dog (1/50, 2%) at a titer of 1:64. All remaining dogs (49/50) were non-seroreactive (titers \leq 1:32) to *B. vinsonii* (*berkhoffii*) antigens.

Phase 1: PCR following direct extraction of blood

Using a *Bartonella* genus real-time PCR probe, 4 of 50 (8%) blood samples tested by PCR without pre-enrichment were positive for *Bartonella* DNA (Table 1). When these 4 samples were separately analyzed using different Taqman® fluorescent, real-time probes that are designed to detect a specific *Bartonella* species (i.e., *B. henselae*, *B. vinsonii* (*berkhoffii*), or *B. quintana*), 2 samples were PCR positive for *B. vinsonii* (*berkhoffii*). One of these 2 dogs was co-infected with 2 *Bartonella* species as determined by conventional PCR using ITS primers, which detected *B. henselae*, and Pap31 primers, which detected *B. vinsonii* (*berkhoffii*); DNA sequencing confirmed *B. henselae* Houston 1 (GenBank: BX897699) and *B. vinsonii* (*berkhoffii*) Type I (GenBank: AY663045). Speciation was not possible for the remaining 2 *Bartonella* genus-positive samples using real-time or

conventional PCR. *Bartonella* DNA was not amplified from the other 46 blood samples or in the negative controls.

Phase 1: Direct inoculation of blood agar plates

Direct inoculation of blood from these 50 dogs yielded no *Bartonella* colony formation on the agar plates over the 6-week incubation period. Further, all control, un-inoculated plates were negative for bacterial growth over the examination period.

Phase 2: Serology

In contrast to phase 1, serum *B. henselae* IgG antibodies were detected in only 10% (5/50) of the phase 2 dogs, all with low reciprocal titers of 64 (3/5) or 128 (2/5). Remaining dogs (45/50) were not seroreactive to *B. henselae* antigens (titers <1:32). Serum *B. vinsonii* (*berkhoffii*) IgG antibodies were detected in 2 dogs (2/50, 4%), with titers of 1:64 or 1:128. All remaining dogs (48/50) were not seroreactive by *B. vinsonii* (*berkhoffii*) IgG antibodies (titers <1:16).

Phase 2: PCR following direct extraction of blood

During phase 2, *Bartonella* DNA was not amplified from any of the 50 blood samples or from any negative control.

Phase 2: Subculturing of liquid pre-enrichment medium onto blood agar plates

After 10 days of pre-enrichment, 4 of 50 liquid culture aliquots (8%) were positive using our *Bartonella* genus real-time PCR probe; however, the Taqman® species-specific probes did not detect *Bartonella* DNA (Table 2). Using conventional PCR, *B. vinsonii* (*berkhoffii*) was detected in 2 of these liquid culture extracts; DNA sequencing confirmed *B. vinsonii* (*berkhoffii*) Type I by ITS (GenBank: AF167988) and Pap31 (GenBank: AY663045) in one sample and *B. vinsonii* (*berkhoffii*) Type II by ITS (GenBank: DQ059763) in the second sample. Further, *B. bovis* was amplified and sequenced using ITS primers (GenBank: AY116638) in the liquid culture aliquots from 2 dogs; these samples are currently undergoing further genetic analysis and review of the case histories.

Sub-inoculation of the pre-enriched culture samples from these 50 dogs to blood agar plates yielded no *Bartonella* colony formation over the 6-week incubation period; no bacterial growth was observed in any negative control.

Phase 3: Serology

Serum *B. henselae* IgG antibodies were detected in 27% (13/48) of the dogs surveyed; the majority had low reciprocal titers of 64 (6/13) or 128 (3/13), although two dogs each were seroreactive at 512 or 1024. All remaining dogs (35/48) were not seroreactive to *B.*

henselae IgG antigens (titers $\leq 1:32$). Serum *B. vinsonii (berkhoffii)* IgG antibodies were detected in 4 dogs, one each at reciprocal titers of 64, 256, 512, and 8192. All 44 remaining dogs were not seroreactive ($\leq 1:16$) to *B. vinsonii (berkhoffii)* antigens.

Phase 3: PCR following direct extraction of blood

Following direct blood extraction, *Bartonella* DNA was amplified from 3 of 48 (6.3%) samples (Table 3). Two of 3 samples contained *B. henselae* when analyzed by our Taqman® fluorescent species-specific, real-time PCR probe; the remaining sample, analyzed by conventional PCR and DNA sequencing, contained *B. henselae* Houston I (GenBank: BX897699) using both ITS and Pap31 primer sets. *Bartonella* DNA was not amplified from the remaining 45 blood samples or the negative controls.

Phase 3: PCR following liquid pre-enrichment culture

Eight of 48 (16.7%) liquid culture extracts contained *Bartonella* DNA after 7 days of modified BAPGM pre-enrichment (Table 3). Using the Taqman® species-specific probes, *B. vinsonii (berkhoffii)* and *B. henselae* were detected in 2 and 5 samples, respectively. Three of the 5 *B. henselae* samples, analyzed by conventional PCR using ITS primers, were subsequently sequenced and identified as *B. henselae* San Antonio 2 strain (GenBank: AF369529). Speciation, using the different Taqman® real-time probes, was not successful for 1 sample; however, conventional PCR using ITS primers, followed by

DNA sequencing, indicated the presence of *B. henselae* Houston I strain (GenBank: BX897699). The remaining 40 blood inoculated, liquid culture aliquots were negative for *Bartonella* DNA, as were the negative controls.

Phase 3: Subculturing onto blood agar plates

Within 7 to 14 days, *Bartonella* colony formation was observed in 6 samples after sub-inoculation of the liquid media onto blood agar plates (Table 3). *Bartonella henselae* DNA was amplified from all 6 plate isolates using ITS primers, and 2 of these dogs were co-infected with *B. henselae* and *B. vinsonii* (*berkhoffii*). DNA sequencing of the isolates confirmed 2 *B. henselae* Houston I isolates (GenBank: BX897699), 2 *B. henselae* San Antonio 2 isolates (GenBank: AF369529), and 2 co-infections with *B. henselae* San Antonio 2 and *B. vinsonii* (*berkhoffii*) Type II (GenBank: AF369529 and DQ059763, respectively). Only 2 of the 6 *B. henselae* isolates remained viable following a second passage to a blood agar plate; both of these isolates were identified as *B. henselae* Houston I (GenBank: BX897699) by DNA sequencing of the ITS region. No colony formation was observed on blood agar plates serving as negative controls.

Discussion

Historically, our research group has often failed to isolate *Bartonella* species from the blood of sick dogs with serological, pathological, or molecular evidence of active infection

(Breitschwerdt et al., 1999; Pappalardo et al., 2000b). Using a newly refined, multi-faceted approach that combines a pre-enrichment liquid culture with PCR amplification, single *Bartonella* species infections were identified in the blood of 19 of 148 sick dogs (12.8%), co-infections with *B. henselae* and *B. vinsonii (berkhoffii)* were detected in 3 of 148 dogs (2.0%), and 2 *B. bovis* infections were identified. To our knowledge, this study is the first to report *B. bovis* infection in dogs. Additionally and perhaps more importantly for comparative microbiological studies, the described approach allowed for the successful agar plate isolation of a single *Bartonella* species in 4 of 148 sick dogs (2.7%) and concurrent agar plate isolation of *B. henselae* and *B. vinsonii (berkhoffii)* in 2 dogs.

Using a reciprocal IFA titer of 64 or greater as an indication of prior or current *Bartonella* infection, the overall seroprevalence in this study was 25% (37/148 dogs). However, in many instances, serology did not correlate with positive PCR amplification followed by DNA sequencing or with the successful isolation of *Bartonella* organisms. Conversely, among the 148 dogs surveyed, 26 *B. henselae* seroreactors and 5 *B. vinsonii (berkhoffii)* seroreactors, with reciprocal titers ranging from 64 to 1024 and 64 to 8192, respectively, were PCR negative; these findings were observed despite pre-enrichment culture in 13 of these 26 *B. henselae* seroreactors and in 4 of 5 *B. vinsonii (berkhoffii)* seroreactors.

Treatment histories were not provided, prior antibiotic treatment may have negatively influenced PCR detection of DNA in *Bartonella* seroreactive dogs.

It has been previously shown that antigenic variability among *B. henselae* test strains can result in false negative *B. henselae* IFA results in human patients with suspected cat scratch disease (Drancourt et al., 1996). In the current study, both *B. henselae* and *B. vinsonii (berkhoffii)* DNA were detected on multiple occasions in dogs that were not seroreactive to the respective *Bartonella* species test antigen. In humans, several reports of the detection and/or isolation of *Bartonella* in seronegative patients have been described (Brouqui et al., 1999; Drancourt et al., 1996; Ehrenborg et al., 2000; Raoult et al., 1994). Despite an overall *Bartonella* seroprevalence of 57% in a series of immunocompetent human patients with arthropod and occupational animal contact, IFA analyses did not correlate with PCR amplification or isolation of *B. vinsonii (berkhoffii)* and *B. henselae* (Breitschwerdt et al., 2007). Considering these data, the results from the current study suggest that the discrepancy between the serological identification of *Bartonella* antibodies and the molecular detection of DNA or bacterial isolation may be a more common occurrence than is currently recognized in both dogs and people.

Despite advances in PCR, improved culture methods are still needed to facilitate the isolation or enhanced detection of *Bartonella* species in patient blood samples. In the current study, *Bartonella* DNA was detected in only 7 of 148 DNA samples (4.7%) following direct extraction of whole blood. Following culture pre-enrichment, *Bartonella* DNA detection increased to 12/148 samples (8.1%), with 5 of 12 samples generating *Bartonella* subculture isolates. During phase 3, *Bartonella* DNA was detected in 3 of 48 blood samples following direct extraction, but these samples were PCR negative following

pre-enrichment culture. This finding indicates that PCR following direct extraction of blood should remain a component of the proposed diagnostic approach. Further, the lack of a positive *Bartonella* PCR result following pre-enrichment culture may have indicated the amplification of non-viable bacteria from the blood sample or may represent a “dilution effect” and failure of the bacteria to proliferate in the liquid media. As *Bartonella* species can reside within endothelial cells, as well as erythrocytes and monocytes, and prior antibiotic treatment could result in the release of non-viable organisms into the systemic circulation. Although treatment status was not routinely provided for the study population, consultations with attending veterinarians by the laboratory director frequently indicated that prior or concurrent administration of one or more antibiotics was being used to treat the dogs in this study at the time of sample collection. As best illustrated by the data summarized during phase 3 of the study, pre-enrichment facilitated PCR documentation of *Bartonella* infection, but subculture to an agar plate to obtain a stable isolate was not successful. This observation is an ongoing limitation of the described approach.

Culture or molecular evidence of co-infection with more than one *Bartonella* species has been frequently reported in cats (Gurfield et al., 1997; Gurfield et al., 2001; Maruyama et al., 2001), occasionally reported in dogs based upon serology (Solano-Gallego et al., 2004), and commonly occurs in some rodent species (Kosoy et al., 1997; Ying et al., 2002). The results of this study provide molecular evidence supporting co-infection with more than one *Bartonella* species in 3 dogs. Using the pre-enrichment approach, co-infection with *B. henselae* and *B. vinsonii* (*berkhoffii*) has now been documented in dogs

from both North America and South America and in immunocompetent people with occupational animal contact and arthropod exposure (Breitschwerdt et al., 2007; Diniz et al., 2007). Based upon the relative insensitivity of the historical methods used to diagnose *Bartonella* infection in companion animals, it is likely that concurrent infection with more than one *Bartonella* species is critically underestimated.

An ideal study of this design would utilize blood from the same 50 dogs in each phase, thereby using the same sample to directly compare the various techniques. Our convenience-sampling design, in conjunction with ongoing efforts to improve detection sensitivity, caused us to use sample types that NCSU-CVM-VBDDL receives as part of the veterinary diagnostic service; therefore, submitted sample volumes were not sufficient to test a single sample using all three methods of direct blood agar plating, pre-enrichment for 10 days, and refined pre-enrichment culture for 7 days. Additionally, because medical history, clinical signs, and prior antibiotic or immunosuppressive drug treatments are often not reported for test submissions, we are unable to make any conclusions pertaining to predisposing clinical conditions or signs that may be associated with the detection or isolation of *Bartonella* bacteria in these dogs.

It is important to note that several of the cases in phase 3 were specifically chosen for study inclusion, and therefore, a sampling bias does exist and may have resulted in the perceived improvement in the methods utilized during this phase of the project. Research is ongoing to continue to improve this multi-faceted, combinational approach so as to

increase the likelihood of *Bartonella* isolation from patient samples. Current work includes the evaluation of different CO₂ concentrations and different temperatures during the incubation period, along with modifications to the solid media used for sub-inoculation, including the utility of BAPGM in a solid matrix.

This combined approach, using liquid pre-enrichment to increase bacterial numbers coupled with highly sensitive, molecular-based diagnostic detection, provides a substantial improvement in microbiological documentation of *Bartonella* infection when compared to traditional inoculation of blood agar plates. This method clearly facilitates the detection and subsequent isolation of single and co-infections with *B. henselae* and *B. vinsonii* (*berkhoffii*) in the blood of naturally infected dogs. The use of a combinational approach of pre-enrichment culture and PCR should assist in the diagnostic confirmation of bartonellosis in dogs.

References

- Boulouis, H.J., Chang, C.C., Henn, J.B., Kasten, R.W., Chomel, B.B., 2005. Factors associated with the rapid emergence of zoonotic *Bartonella* infections. *Vet. Res.* 36 (3), 383-410.
- Breitschwerdt, E.B., Maggi, R.G., Duncan, A.W., Nicholson, W.L., Hegarty, B.C., Woods, C.W., 2007. Isolation of *Bartonella henselae* and *Bartonella vinsonii* subsp. *berkhoffii* from the blood of immunocompetent persons with arthropod and occupational animal contact. In press at *Emerging Infectious Diseases*.
- Breitschwerdt, E.B., Atkins, C.E., Brown, T.T., Kordick, D.L., Snyder, P.S., 1999. *Bartonella vinsonii* subsp. *berkhoffii* and related members of the alpha subdivision of the *Proteobacteria* in dogs with cardiac arrhythmias, endocarditis, or myocarditis. *J. Clin. Microbiol.* 37 (11), 3618-3626.
- Breitschwerdt, E.B., Blann, K.R., Stebbins, M.E., Munana, K.R., Davidson, M.G., Jackson, H.A., Willard, M.D., 2004. Clinicopathological abnormalities and treatment response in 24 dogs seroreactive to *Bartonella vinsonii* (*berkhoffii*) antigens. *J. Am. Anim. Hosp. Assoc.* 40 (2), 92-101.
- Breitschwerdt, E.B., Hegarty, B.C., Maggi, R., Hawkins, E., Dyer, P., 2005. *Bartonella* species as a potential cause of epistaxis in dogs. *J. Clin. Microbiol.* 43 (5), 2529-2533.

Breitschwerdt, E.B., Kordick, D.L., 2000. *Bartonella* infection in animals: Carriership, reservoir potential, pathogenicity, and zoonotic potential for human infection. Clin. Microbiol. Rev. 13 (3), 428-438.

Breitschwerdt, E.B., Kordick, D.L., Malarkey, D.E., Keene, B., Hadfield, T.L., Wilson, K., 1995. Endocarditis in a dog due to infection with a novel *Bartonella* subspecies. J. Clin. Microbiol. 33 (1), 154-160.

Brouqui, P., La Scola, B., Roux, V., Raoult, D., 1999. Chronic *Bartonella quintana* bacteremia in homeless patients. N. Engl. J. Med. 340 (3), 184-189.

Chenoweth, M.R., Somerville, G.A., Krause, D.C., O'Reilly, K.L., Gherardini, F.C., 2004. Growth characteristics of *Bartonella henselae* in a novel liquid medium: Primary isolation, growth-phase-dependent phage induction, and metabolic studies. Appl. Environ. Microbiol. 70 (2), 656-663.

Chomel, B.B., Boulouis, H.J., Breitschwerdt, E.B., 2004. Cat scratch disease and other zoonotic *Bartonella* infections. J. Am. Vet. Med. Assoc. 224 (8), 1270-1279.

Chomel, B.B., Boulouis, H.J., Maruyama, S., Breitschwerdt, E.B., 2006. *Bartonella* spp. in pets and effect on human health. Emerg. Infect. Dis. 12 (3), 389-394.

Chomel, B.B., Kasten, R.W., Sykes, J.E., Boulouis, H.J., Breitschwerdt, E.B., 2003. Clinical impact of persistent *Bartonella* bacteremia in humans and animals. Ann. N. Y. Acad. Sci. 990 267-278.

- Chomel, B.B., Mac Donald, K.A., Kasten, R.W., Chang, C.C., Wey, A.C., Foley, J.E., Thomas, W.P., Kittleson, M.D., 2001. Aortic valve endocarditis in a dog due to *Bartonella clarridgeiae*. J. Clin. Microbiol. 39 (10), 3548-3554.
- Clarridge, J.E., 3rd, Raich, T.J., Pirwani, D., Simon, B., Tsai, L., Rodriguez-Barradas, M.C., Regnery, R., Zollo, A., Jones, D.C., Rambo, C., 1995. Strategy to detect and identify *Bartonella* species in routine clinical laboratory yields *Bartonella henselae* from human immunodeficiency virus-positive patient and unique *Bartonella* strain from his cat. J. Clin. Microbiol. 33 (8), 2107-2113.
- Dehio, C., 2001. *Bartonella* interactions with endothelial cells and erythrocytes. Trends Microbiol. 9 (6), 279-285.
- Diniz, P.P.V.P., Maggi, R.G., Schwartz, D.S., Cadenas, M.B., Bradley, J.M., Hegarty, B.C., Breitschwerdt, E.B., 2007. Canine bartonellosis: serological and molecular prevalence in Brazil and evidence of co-infection with *Bartonella henselae* and *Bartonella vinsonii* subsp. *berkhoffii*. In press at Veterinary Research.
- Drancourt, M., Moal, V., Brunet, P., Dussol, B., Berland, Y., Raoult, D., 1996. *Bartonella (Rochalimaea) quintana* infection in a seronegative hemodialyzed patient. J. Clin. Microbiol. 34 (5), 1158-1160.
- Ehrenborg, C., Wesslen, L., Jakobson, A., Friman, G., Holmberg, M., 2000. Sequence variation in the *ftsZ* gene of *Bartonella henselae* isolates and clinical samples. J. Clin. Microbiol. 38 (2), 682-687.

- Fournier, P.E., Robson, J., Zeaiter, Z., McDougall, R., Byrne, S., Raoult, D., 2002. Improved culture from lymph nodes of patients with cat scratch disease and genotypic characterization of *Bartonella henselae* isolates in Australia. *J. Clin. Microbiol.* 40 (10), 3620-3624.
- Gillespie, T.N., Washabau, R.J., Goldschmidt, M.H., Cullen, J.M., Rogala, A.R., Breitschwerdt, E.B., 2003. Detection of *Bartonella henselae* and *Bartonella clarridgeiae* DNA in hepatic specimens from two dogs with hepatic disease. *J. Am. Vet. Med. Assoc.* 222 (1), 47-51, 35.
- Gouriet, F., Fenollar, F., Patrice, J.Y., Drancourt, M., Raoult, D., 2005. Use of shell-vial cell culture assay for isolation of bacteria from clinical specimens: 13 years of experience. *J. Clin. Microbiol.* 43 (10), 4993-5002.
- Gurfield, A.N., Boulouis, H.J., Chomel, B.B., Heller, R., Kasten, R.W., Yamamoto, K., Piemont, Y., 1997. Coinfection with *Bartonella clarridgeiae* and *Bartonella henselae* and with different *Bartonella henselae* strains in domestic cats. *J. Clin. Microbiol.* 35 (8), 2120-2123.
- Gurfield, A.N., Boulouis, H.J., Chomel, B.B., Kasten, R.W., Heller, R., Bouillin, C., Gandoin, C., Thibault, D., Chang, C.C., Barrat, F., Piemont, Y., 2001. Epidemiology of *Bartonella* infection in domestic cats in France. *Vet. Microbiol.* 80 (2), 185-198.
- Henn, J.B., Liu, C.H., Kasten, R.W., VanHorn, B.A., Beckett, L.A., Kass, P.H., Chomel, B.B., 2005. Seroprevalence of antibodies against *Bartonella* species and evaluation of risk

factors and clinical signs associated with seropositivity in dogs. *Am. J. Vet. Res.* 66 (4), 688-694.

Houpikian, P., Raoult, D., 2001. 16S/23S rRNA intergenic spacer regions for phylogenetic analysis, identification, and subtyping of *Bartonella* species. *J. Clin. Microbiol.* 39 (8), 2768-2778.

Jacomo, V., Kelly, P.J., Raoult, D., 2002. Natural history of *Bartonella* infections (an exception to Koch's postulate). *Clin. Diagn. Lab. Immunol.* 9 (1), 8-18.

Joblet, C., Roux, V., Drancourt, M., Gouvernet, J., Raoult, D., 1995. Identification of *Bartonella (Rochalimaea)* species among fastidious gram-negative bacteria on the basis of the partial sequence of the citrate-synthase gene. *J. Clin. Microbiol.* 33 (7), 1879-1883.

Kitchell, B.E., Fan, T.M., Kordick, D., Breitschwerdt, E.B., Wollenberg, G., Lichtensteiger, C.A., 2000. Peliosis hepatitis in a dog infected with *Bartonella henselae*. *J. Am. Vet. Med. Assoc.* 216 (4), 519-23, 517.

Kordick, D.L., Breitschwerdt, E.B., 1995. Intraerythrocytic presence of *Bartonella henselae*. *J. Clin. Microbiol.* 33 (6), 1655-1656.

Kordick, D.L., Hilyard, E.J., Hadfield, T.L., Wilson, K.H., Steigerwalt, A.G., Brenner, D.J., Breitschwerdt, E.B., 1997. *Bartonella clarridgeiae*, a newly recognized zoonotic pathogen causing inoculation papules, fever, and lymphadenopathy (cat scratch disease). *J. Clin. Microbiol.* 35 (7), 1813-1818.

Kordick, D.L., Swaminathan, B., Greene, C.E., Wilson, K.H., Whitney, A.M., O'Connor, S., Hollis, D.G., Matar, G.M., Steigerwalt, A.G., Malcolm, G.B., Hayes, P.S., Hadfield, T.L., Breitschwerdt, E.B., Brenner, D.J., 1996. *Bartonella vinsonii* subsp. *berkhoffii* subsp. nov., isolated from dogs; *Bartonella vinsonii* subsp. *vinsonii*; and emended description of *Bartonella vinsonii*. Int. J. Syst. Bacteriol. 46 (3), 704-709.

Kosoy, M.Y., Regnery, R.L., Tzianabos, T., Marston, E.L., Jones, D.C., Green, D., Maupin, G.O., Olson, J.G., Childs, J.E., 1997. Distribution, diversity, and host specificity of *Bartonella* in rodents from the southeastern United States. Am. J. Trop. Med. Hyg. 57 (5), 578-588.

La Scola, B., Raoult, D., 1999. Culture of *Bartonella quintana* and *Bartonella henselae* from human samples: A 5-year experience (1993 to 1998). J. Clin. Microbiol. 37 (6), 1899-1905.

MacDonald, K.A., Chomel, B.B., Kittleson, M.D., Kasten, R.W., Thomas, W.P., Pesavento, P., 2004. A prospective study of canine infective endocarditis in northern California (1999-2001): Emergence of *Bartonella* as a prevalent etiologic agent. J. Vet. Intern. Med. 18 (1), 56-64.

Maggi, R.G., Duncan, A.W., Breitschwerdt, E.B., 2005a. Novel chemically modified liquid medium that will support the growth of seven *Bartonella* species. J. Clin. Microbiol. 43 (6), 2651-2655.

Maggi, R.G., Harms, C.A., Hohn, A.A., Pabst, D.A., McLellan, W.A., Walton, W.J., Rotstein, D.S., Breitschwerdt, E.B., 2005b. *Bartonella henselae* in porpoise blood. Emerg. Infect. Dis. 11 (12), 1894-1898.

Maruyama, S., Sakai, T., Morita, Y., Tanaka, S., Kabeya, H., Boonmar, S., Poapolathep, A., Chalarmchaikit, T., Chang, C.C., Kasten, R.W., Chomel, B.B., Katsube, Y., 2001. Prevalence of *Bartonella* species and 16s rRNA gene types of *Bartonella henselae* from domestic cats in Thailand. Am. J. Trop. Med. Hyg. 65 (6), 783-787.

Maurin, M., Birtles, R., Raoult, D., 1997. Current knowledge of *Bartonella* species. Eur. J. Clin. Microbiol. Infect. Dis. 16 (7), 487-506.

Mexas, A.M., Hancock, S.I., Breitschwerdt, E.B., 2002. *Bartonella henselae* and *Bartonella elizabethae* as potential canine pathogens. J. Clin. Microbiol. 40 (12), 4670-4674.

Pappalardo, B.L., Brown, T., Gebhardt, D., Sontakke, S., Breitschwerdt, E.B., 2000a. Cyclic CD8+ lymphopenia in dogs experimentally infected with *Bartonella vinsonii* subsp. *berkhoffii*. Vet. Immunol. Immunopathol. 75 (1-2), 43-57.

Pappalardo, B.L., Brown, T., Gookin, J.L., Morrill, C.L., Breitschwerdt, E.B., 2000b. Granulomatous disease associated with *Bartonella* infection in 2 dogs. J. Vet. Intern. Med. 14 (1), 37-42.

- Pappalardo, B.L., Brown, T.T., Tompkins, M., Breitschwerdt, E.B., 2001. Immunopathology of *Bartonella vinsonii (berkhoffii)* in experimentally infected dogs. *Vet. Immunol. Immunopathol.* 83 (3-4), 125-147.
- Raoult, D., Drancourt, M., Carta, A., Gastaut, J.A., 1994. *Bartonella (Rochalimaea) quintana* isolation in patient with chronic adenopathy, lymphopenia, and a cat. *Lancet* 343 (8903), 977.
- Regnery, R.L., Anderson, B.E., Clarridge, J.E., 3rd, Rodriguez-Barradas, M.C., Jones, D.C., Carr, J.H., 1992. Characterization of a novel *Rochalimaea* species, *R. henselae* sp. nov., isolated from blood of a febrile, human immunodeficiency virus-positive patient. *J. Clin. Microbiol.* 30 (2), 265-274.
- Rolain, J.M., Foucault, C., Guieu, R., La Scola, B., Brouqui, P., Raoult, D., 2002. *Bartonella quintana* in human erythrocytes. *Lancet* 360 (9328), 226-228.
- Rolain, J.M., La Scola, B., Liang, Z., Davoust, B., Raoult, D., 2001. Immunofluorescent detection of intraerythrocytic *Bartonella henselae* in naturally infected cats. *J. Clin. Microbiol.* 39 (8), 2978-2980.
- Solano-Gallego, L., Bradley, J., Hegarty, B., Sigmon, B., Breitschwerdt, E., 2004. *Bartonella henselae* IgG antibodies are prevalent in dogs from southeastern USA. *Vet. Res.* 35 (5), 585-595.

Welch, D.F., Pickett, D.A., Slater, L.N., Steigerwalt, A.G., Brenner, D.J., 1992.

Rochalimaea henselae sp. nov., a cause of septicemia, bacillary angiomatosis, and parenchymal bacillary peliosis. J. Clin. Microbiol. 30 (2), 275-280.

Ying, B., Kosoy, M.Y., Maupin, G.O., Tsuchiya, K.R., Gage, K.L., 2002. Genetic and ecologic characteristics of *Bartonella* communities in rodents in southern China. Am. J. Trop. Med. Hyg. 66 (5), 622-627.

Phase 1:

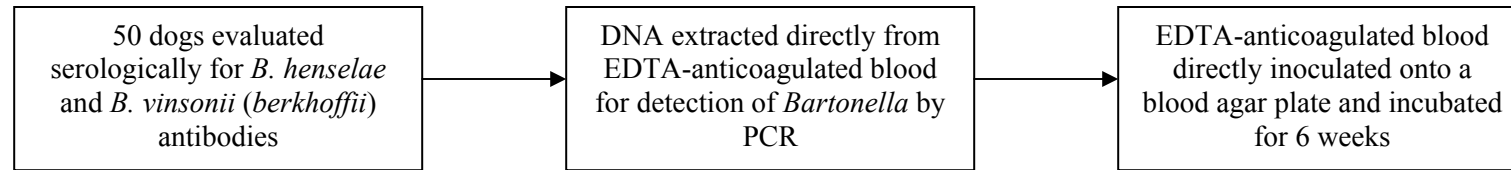

Phase 2:

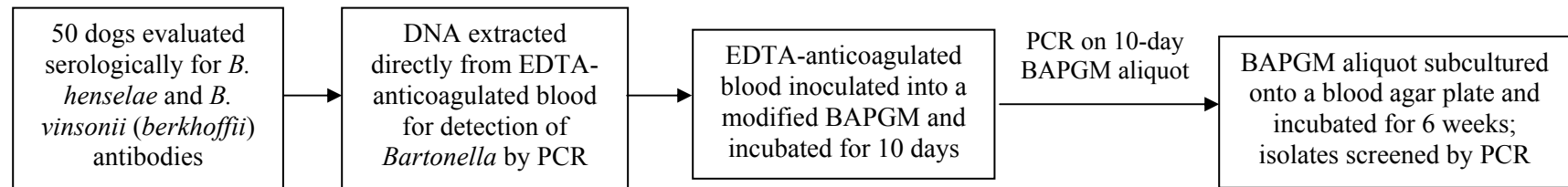

Phase 3:

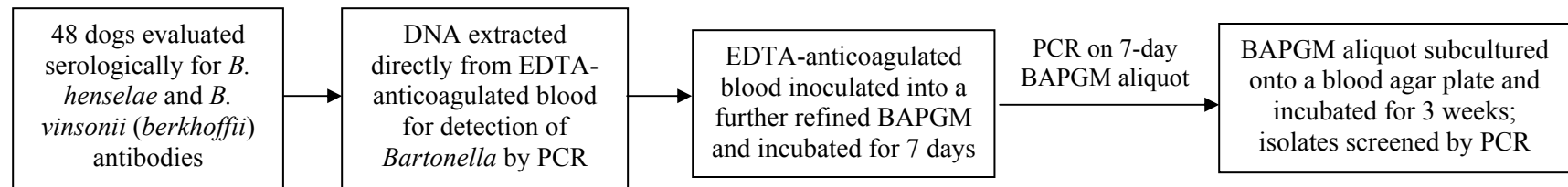

Figure 1. Study design schematic indicating the three distinct phases of the current work. *Bartonella* exposure was assessed using indirect immunofluorescence assays, while *Bartonella* DNA, if present, was detected by PCR. Microbiological techniques included direct inoculation of a 5% rabbit blood agar plate or use of a novel, liquid media (*Bartonella*/alpha-*Proteobacteria* growth media, BAPGM) for pre-enrichment prior to sub-inoculation of a blood agar plate.

Table 1. Results for *Bartonella* PCR-positive dogs from phase 1. Immunofluorescence assay (IFA) reciprocal titers, real-time PCR using genus- and species-specific probes targeting the intergenic transcribed spacer (ITS) sequence of *Bartonella*, and conventional PCR results targeting the ITS and phage-associated protein (Pap31) sequence are shown. DNA extracted from EDTA-anticoagulated blood was analyzed by PCR. Whole blood was also directly applied to a blood agar plate and no colony growth was observed.

No.	Breed, Sex, Age (yr)	<i>B. henselae</i> IFA titer	<i>B. vinsonii (berkhoffii)</i> IFA titer	<i>Bartonella</i> genus by real-time PCR	<i>Bartonella</i> species by real-time PCR ¹	Conventional PCR and DNA sequencing
1	Terrier mix, FS, 3	64	<16	(+)	<i>B. vinsonii (berkhoffii)</i>	(-) by conventional PCR
2	Golden retriever, FS, 10	64	<16	(+)	<i>B. vinsonii (berkhoffii)</i>	<i>B. vinsonii (berkhoffii)</i> Type I by Pap31, <i>B. henselae</i> Houston I by ITS
3	German shepherd, MN, 1	64	<16	(+)	(-)	(-) by conventional PCR
4	American bulldog, M, 5	<16	<16	(+)	(-)	(-) by conventional PCR

FS: Female spayed, MN: male neutered
 Reciprocal IFA of ≥ 64 are considered to be seroreactive.

(+) = PCR positive (-) = PCR negative

¹ Using a Taqman® fluorescent, real-time PCR probe designed to specifically detect *B. henselae*, *B. vinsonii (berkhoffii)*, or *B. quintana*.

GenBank accession numbers: *Bartonella vinsonii (berkhoffii)* Type I by Pap31 primers (AY663045), *B. henselae* Houston I (BX897699)

Table 2. Results for *Bartonella* PCR-positive dogs from phase 2. Immunofluorescence assay (IFA) reciprocal titers, real-time PCR using genus- and species-specific probes targeting the intergenic transcribed spacer (ITS) sequence of *Bartonella*, and conventional PCR results targeting the ITS and phage-associated protein (Pap31) sequence are shown. DNA extracted from EDTA-anticoagulated blood was analyzed by PCR. Liquid culture pre-enrichment medium was inoculated with whole blood and maintained in a 5% CO₂, water-saturated atmosphere for 10 days prior to sub-inoculation of a blood agar plate. No colony growth was observed.

No.	Breed, Sex, Age (yr)	<i>B. henselae</i> IFA titer	<i>B. vinsonii</i> (<i>berkhoffii</i>) IFA titer	<i>Bartonella</i> genus real-time PCR on blood	<i>Bartonella</i> genus real-time PCR on 10-day liquid culture aliquot	<i>Bartonella</i> species real-time PCR on 10-day liquid culture aliquot ¹	Conventional PCR and DNA sequencing
1	Pekingese, F, 7	<16	<16	(-)	(+)	(-)	<i>B. vinsonii</i> (<i>berkhoffii</i>) Type I by ITS and Pap31
2	Australian shepherd, FS, 12	<16	<16	(-)	(+)	(-)	<i>B. vinsonii</i> (<i>berkhoffii</i>) Type II by ITS
3	West highland terrier, MN, 11	64	<16	(-)	(+)	(-)	<i>B. bovis</i> by ITS
4	Greyhound, MN, 6	<16	<16	(-)	(+)	(-)	<i>B. bovis</i> by ITS

FS: Female spayed, MN: male neutered
 Reciprocal IFA of ≥ 64 are considered to be seroreactive.

Table 2. (continued).

(+) = PCR positive (-) = PCR negative

¹ Using a Taqman® fluorescent, real-time PCR probe designed to specifically detect *B. henselae*, *B. vinsonii* (*berkhoffii*), or *B. quintana*.

GenBank accession numbers: *Bartonella vinsonii* (*berkhoffii*) Type I by ITS (AF167988) and Pap31 (AY663045) primers, *B. vinsonii* (*berkhoffii*) Type II by ITS primers (DQ059763), and *B. bovis* by ITS primers (AY116638)

Table 3. Results for selected *Bartonella* seroreactive and PCR-positive dogs from phase 3. Immunofluorescence assay (IFA) reciprocal titers, real-time PCR using genus- and species-specific probes targeting the intergenic transcribed spacer (ITS) sequence of *Bartonella*, and conventional PCR results targeting the ITS and phage-associated protein (Pap31) sequence are shown. PCR analysis was performed using: (1) direct extraction from EDTA-anticoagulated blood, (2) an aliquot of the pre-enrichment liquid culture after a 7-day incubation period, and (3) from colonies, scraped and resuspended in phosphate-buffered saline, grown on blood agar plates.

No.	Breed, Sex, Age (yr)	<i>B. henselae</i> IFA titer	<i>B. vinsonii</i> (<i>berkhoffii</i>) IFA titer	PCR on blood	PCR on 7-day liquid culture aliquot	<i>Bartonella</i> colonies on subcultured blood agar plate	PCR on colony resuspension
1	English Springer spaniel, MN, 7	128	64	(-)	<i>B. vinsonii</i> (<i>berkhoffii</i>)	Yes	<i>B. henselae</i> ²
2	Boston terrier, MN, 5	<16	<16	(-)	<i>B. henselae</i> ²	Yes	<i>B. henselae</i> ²
3	Belgian malinois, MN, 7	1024	256	(-)	<i>B. henselae</i>	Yes	<i>B. henselae</i> & <i>B. vinsonii</i> (<i>berkhoffii</i>) ⁴
4	Weimaraner, FS, 4	<16	<16	<i>B. henselae</i>	(-)	No	Not tested
5	German shepherd, MN, 8	<16	<16	(-)	<i>B. henselae</i> ³	Yes	<i>B. henselae</i> ³
6	Golden retriever, FS, 4	64	<16	(-)	<i>B. henselae</i> ³	No	Not tested

Table 3 (continued).

No.	Breed, Sex, Age (yr)	<i>B. henselae</i> IFA titer	<i>B. vinsonii</i> (<i>berkhoffii</i>) IFA titer	PCR on blood	PCR on 7-day liquid culture aliquot	<i>Bartonella</i> colonies on subcultured blood agar plate	PCR on colony resuspension
7	Komondor, M, 8	<16	<16	(-)	<i>B. henselae</i> ³	Yes	<i>B. henselae</i> & <i>B. vinsonii</i> (<i>berkhoffii</i>) ⁴
8	Italian greyhound, FS, 2	<16	<16	<i>B. henselae</i>	(-)	No	Not tested
9	Golden retriever, FS, 8	64	<16	<i>B. henselae</i> ¹	(-)	No	Not tested
10	Golden retriever, MN, 9	<16	<16	(-)	<i>B. vinsonii</i> (<i>berkhoffii</i>)	No	Not tested
11	Golden retriever, MN, 9	<16	<16	(-)	<i>B. henselae</i>	No	Not tested
12	Belgian terriere, M, 6	<16	<16	(-)	(-)	Yes	<i>B. henselae</i> ³
13	Lab mix, MN, 11	512	8192	(-)	(-)	No	Not tested
14	Golden retriever, FS, 2	512	<16	(-)	(-)	No	Not tested

Table 3 (continued).

No.	Breed, Sex, Age (yr)	<i>B. henselae</i> IFA titer	<i>B. vinsonii (berkhoffii)</i> IFA titer	PCR on blood	PCR on 7-day liquid culture aliquot	<i>Bartonella</i> colonies on subcultured blood agar plate	PCR on colony resuspension
15	Schipperke, FS, 6	1024	<16	(-)	(-)	No	Not tested
16	American bulldog, MN, 7	128	512	(-)	(-)	No	Not tested

FS: Female spayed, MN: male neutered

Serological titers of $\geq 1:64$ are considered to be seroreactive.

¹ Real-time PCR positive for *Bartonella* genus only. Species-specific, Taqman® real-time PCR probes did not detect *B. henselae*, *B. vinsonii (berkhoffii)*, or *B. quintana*. However, conventional PCR and DNA sequencing indicated *B. henselae* Houston I by ITS and Pap31 primer sets.

² Real-time PCR positive for *Bartonella* genus only. Species-specific, Taqman® real-time PCR probes did not detect *B. henselae*, *B. vinsonii (berkhoffii)*, or *B. quintana*. However, conventional PCR and DNA sequencing indicated *B. henselae* Houston I by ITS primers.

³ DNA sequencing indicated *B. henselae* San Antonio 2 by ITS primers.

⁴ DNA sequencing indicated co-infection with *B. henselae* San Antonio 2 and *B. vinsonii (berkhoffii)* Type II by ITS primers.

GenBank accession numbers: *Bartonella henselae* Houston I (BX897699), *B. henselae* San Antonio 2 by ITS primers (AF369529), *B. vinsonii (berkhoffii)* Type II by ITS primers (DQ059763).

**Chapter 4. *Bartonella henselae* and *B. vinsonii* subspecies
berkhoffii in blood of immunocompetent persons with arthropod
and animal contact**

Manuscript as accepted for publication at Emerging Infectious Diseases. Minor modifications of manuscript tables required to accommodate margins.

Breitschwerdt, E.B., Maggi, R.G., Duncan, A.W., Nicholson, W.L., Hegarty, B.C., Woods, C.W., 2007. Isolation of *Bartonella henselae* and *Bartonella vinsonii* subsp. *berkhoffii* from the blood of immunocompetent persons with arthropod and occupational animal contact. In press at Emerging Infectious Diseases.

***Bartonella henselae* and *B. vinsonii* subspecies *berkhoffii* in Blood of
Immunocompetent Persons with Arthropod and Animal Contact**

Edward B. Breitschwerdt,* Ricardo G. Maggi,* Ashlee W. Duncan,*

William L. Nicholson,† Barbara C. Hegarty,*

and Christopher W. Woods‡

*North Carolina State University College of Veterinary Medicine, Raleigh, North Carolina, USA, †Centers for Disease Control and Prevention, Atlanta, Georgia, USA; and ‡Duke University Medical Center, Durham, North Carolina, USA

Correspondence should be addressed to Dr. Breitschwerdt at the North Carolina State University College of Veterinary Medicine, 4700 Hillsborough Street, Raleigh, NC 27606, or at ed_breitschwerdt@ncsu.edu, office 919-513-8277, fax 919-513-6336.

Keywords: Bartonella, culture, PCR, immunocompetent, fatigue

Abstract

Using PCR in conjunction with pre-enrichment culture, we detected *Bartonella henselae* and *B. vinsonii* subspecies *berkhoffii* in the blood of 14 immunocompetent persons with frequent animal contact and arthropod exposure.

Introduction

Attempts to isolate *Bartonella* sp. from immunocompetent persons with serologic, pathologic, or molecular evidence of infection are often unsuccessful, and several investigators have indicated that *Bartonella* isolation methods need to be improved (1–4). By combining PCR and pre-enrichment culture, *B. henselae* and *B. vinsonii* subspecies *berkhoffii* infection was detected in the blood of immunocompetent persons with arthropod and occupational animal exposure.

The study

From November 2004 through June 2005, blood and serum samples from 42 persons were tested, and 14 completed a questionnaire, approved by the North Carolina State University Institutional Review Board. Age, sex, animal contact, history of bites, environment, outdoor activity, arthropod contact, travel, and medical history were surveyed. Bacterial isolation, PCR amplification, and cloning were performed by using previously described methods (5–7). Each blood sample was tested by PCR after direct

DNA extraction, pre-enrichment culture for at least 7 days, and subculture onto a blood agar plate (Figure 1). An uninoculated, pre-enrichment culture was processed simultaneously as a control. Methods used for DNA extraction and conventional and real-time PCR targeting of the *Bartonella* 16S-23S intergenic spacer region (ITS) and heme binding protein (Pap31) gene have been described (7,8). Conventional PCR amplicons were cloned with the pGEM-T Easy Vector System (Promega, Madison, WI, USA); sequencing was performed by Davis Sequencing, Inc. (Davis, CA, USA). Sequences were aligned and compared with GenBank sequences with AlignX software (Vector NTI Suite 6.0, InforMax, Inc.) (7,8). *B. vinsonii* subsp. *berkhoffii*, *B. henselae*, and *B. quintana* antibodies were determined by using a modification of a previously described immunofluorescence antibody assay (IFA) procedure (9).

Study participants included 12 women and 2 men, ranging in age from 30 to 53 years; all of them reported occupational animal contact for >10 years (Table 1). Most had daily contact with cats (13 persons) and dogs (12 persons). All participants reported animal bites or scratches (primarily from cats) and arthropod exposure, including fleas, ticks, biting flies, mosquitoes, lice, mites, or chiggers. All participants reported intermittent or chronic clinical symptoms, including fatigue, arthralgia, myalgia, headache, memory loss, ataxia, and paresthesia (Table 2). Illness was most frequently mild to moderate in severity, with a waxing and waning course, and all but 2 persons could perform occupational activities. Of the 14 participants, 9 had been evaluated by a cardiologist, 8 each by an infectious disease physician or a neurologist, and 5 each by an internist or a rheumatologist. Eleven participants had received antimicrobial drugs.

Using reciprocal titers of >64, 8 persons were seroreactive to *Bartonella* antigens (Table 3). *B. henselae* or *B. vinsonii* subsp. *berkhoffii* was detected or isolated from all 14 participants. At the time of initial testing, *Bartonella* DNA was amplified directly from 3 blood samples, from 7 pre-enrichment liquid cultures, and from 4 subculture isolates (Table 3). For 5 persons, results of PCR and culture of initial samples were negative. Overall, *Bartonella* DNA was amplified from 11 (28%) of 40 extracted blood samples, 13 (33%) of 40 pre-enrichment cultures, and 5 isolates. For 7 persons, *B. henselae* DNA was amplified at multiple time points. *Bartonella* DNA was never amplified from any PCR control or uninoculated culture control.

Using the ITS target region, two distinct *B. henselae* strains were sequenced, *B. henselae* Houston I (HI) (GenBank NC-005956) and *B. henselae* San Antonio 2 (SA2) (GenBank AF369529). Within the noncoding ITS region, *B. henselae* SA2 strains have a 30-bp insertion (ATT GCT TCT AAA AAG ATT GCT TCT AAA AAG) located 518 bases downstream from the 16S gene. Pap31 sequences (545 bases) do not differ between the 2 strains. Only *B. vinsonii* subsp. *berkhoffii* types I and II were detected (8).

Persistent human infection with *B. bacilliformis* and *B. quintana* has been previously documented, whereas infection with *B. henselae* (cat-scratch disease [CSD]) is generally considered self-limiting (1,2,10). Recently, *B. henselae* DNA was amplified from the blood of a child 4 months after CSD diagnosis (11). Our study indicates that *B. henselae* and *B. vinsonii* subsp. *berkhoffii* can induce occult infection in immunocompetent persons and that detection can be enhanced by combining PCR with pre-enrichment culture. Considering only the results from initial blood samples, PCR detected *Bartonella*

DNA in 3 samples, all of which were subsequently PCR positive by subculture or enrichment culture. In samples from 5 persons, pre-enrichment was necessary, and in 5 other persons, sequential sampling was necessary to detect *Bartonella* infection. Intermittent bacteremia, as occurs in *B. henselae*-infected cats (12), antimicrobial drug administration, low bacterial copy numbers, and low inoculum volume (1 mL) may have contributed to intermittent detection or inability to isolate *Bartonella* spp. from some participant samples. Although an improvement over historical isolation approaches, our results emphasize ongoing limitations associated with the detection of *Bartonella* infection. Obtaining stable *Bartonella* subcultures (n = 5 in this study) has proven problematic for other specialized laboratories that routinely culture for *Bartonella* spp. (3,4). To our knowledge, the *B. vinsonii* subsp. *berkhoffii* type II isolate described in our study is the only type II human isolate reported to date (8). Various combinations of *B. henselae* and *B. vinsonii* subsp. *berkhoffii* strain types were detected in the same blood sample or sequential blood samples. The coexistence of *B. henselae* genetic variants has been described among primary patient isolates, which suggests that multiple genotypes may emerge within the same person (13).

Overall, 57% of persons tested were seroreactive to 1 or all 3 *Bartonella* test antigens. Previous reports from the United States identified a *B. henselae* seroprevalence of 3% in healthy blood donors and a cumulative seroprevalence of 7.1% to both *B. henselae* and *B. quintana* antigens in veterinary professionals (1). In this and other studies, serologic test results did not correlate with PCR amplification or isolation results. Antigenic variability among *B. henselae* test strains can cause false-negative IFA results in

persons with suspected CSD. Also *B. henselae*, *B. quintana*, or *B. elizabethae* antibodies were not detected in some persons with DNA evidence of active infection (1,3,4).

Animal contact, often to a wide spectrum of domestic and wild animal species, is an obvious consequence of the daily activities of the study population, which is biased by veterinary occupational exposure and by self-selection (volunteer bias). Cats are considered the primary reservoir host for *B. henselae*, whereas coyotes and foxes are considered reservoir hosts for *B. vinsonii* subsp. *berkhoffii* (1,2,8). Detection of *B. vinsonii* subsp. *berkhoffii* in 4 of 5 Californian participants could be related to the high prevalence of bacteremic coyotes in this region as well as to the potential transmission by a tick vector (1,2). All 14 participants reported frequent arthropod exposure. Although *Bartonella* transmission by ticks has not been proven, several recent studies have identified *Bartonella* DNA in questing ticks, ticks attached to animals, and ticks attached to humans (1,2,14).

Despite reporting chronic or episodic illness, most participants continued to effectively maintain daily professional and personal activities. The symptoms described in the study patients are very similar to those described in a community and hospital-based surveillance study of CSD patients, in whom CSD-associated arthropathy was an uncommon chronic syndrome affecting mostly young and middle-age women (15). Our study was initiated to investigate the feasibility of combining PCR with pre-enrichment culture. Prospective studies, with appropriate controls, are needed to characterize the prevalence and clinical relevance of persistent *Bartonella* infection in immunocompetent persons.

Acknowledgements

We wish to thank the study participants for providing blood samples, Julie Bradley and Maria Belen Cadenas for technical assistance, and Tonya Lee for editorial assistance. This research was supported by the State of North Carolina and in part through a gift from Bayer Animal Health.

References

1. Chomel BB, Kasten RW, Sykes JE, Boulouis H-J, Breitschwerdt EB. Clinical impact of persistent *Bartonella* bacteremia in humans and animals. *Ann N Y Acad Sci.* 2003;990:1-12.
2. Boulouis H-J, Chang CC, Henn JB, Kasten RW, Chomel BB. Factors associated with the rapid emergence of zoonotic *Bartonella* infections. *Vet Res.* 2005;36:383-410.
3. La Scola B, Raoult D. Culture of *Bartonella quintana* and *Bartonella henselae* from human samples: a 5-year experience (1993-1998). *J Clin Microbiol.* 1999;37:1899-1905.
4. Gouriet F, Fenollar F, Patrice JY, Dancourt M, Raoult D. Use of shell-vial cell culture assay for isolation of bacteria from clinical specimens: 13 years of experience. *J Clin Microbiol.* 2005;43:4993-5002.
5. Maggi RG, Harms CA, Hohn AA, Pabst DA, McLellan WA, Walton WJ, et al. *Bartonella henselae* in porpoise blood. *Emerg Infect Dis.* 2005;11:1894-98.

6. Breitschwerdt EB, Maggi RG, Sigmon B, Nicholson WL. Isolation of *Bartonella quintana* from a woman and a cat following putative bite transmission. J Clin Microbiol 2007;45:270-72.
7. Maggi RG, Breitschwerdt EB. Potential limitations of the 16S-23S rRNA intergenic region for the molecular detection of *Bartonella* species. J Clin Microbiol. 2005;43:1171-76.
8. Maggi RG, Chomel B, Hegarty BC, Henn J, Breitschwerdt EB. A *Bartonella vinsonii berkhoffii* typing scheme based upon 16S-23S ITS and Pap31 sequences from dog, coyote, gray fox, and human isolates. Mol Cell Probes. 2006;20:128-34.
9. Dalton MJ, Robinson LE, Copper J, Regnery RL, Olson JG, Childs JE. Use of Bartonella antigens for serologic diagnosis of cat-scratch disease at a national referral center. Arch Intern Med. 1995;155:1670-76.
10. Brouqui P, La Scola B, Roux V, Raoult D. Chronic *Bartonella quintana* bacteremia in homeless patients. N Engl J Med. 1999;340:184-9.
11. Arvand M, Schad SG. Isolation of *Bartonella henselae* DNA from the peripheral blood of a patient with cat scratch disease up to 4 months after the cat scratch injury. J Clin Microbiol. 2006 44:2288-90.
12. Kordick DL, Brown TT, Shin KO, Breitschwerdt EB. Clinical and pathological evaluation of chronic *Bartonella henselae* or *Bartonella clarridgeiae* infection in cats. J Clin Microbiol. 1999;37:1536-47.
13. Arvand M, Schubert H, Viezens J. Emergence of distinct genetic variants in the population of primary *Bartonella henselae* isolates. Microbes Infect. 2006;8:1315-20.

14. Adelson ME, Rao RV, Tilton RC, Cabets K, Eskow E, Fein L, et al. Prevalence of *Borrelia burgdorferi*, *Bartonella*, *Babesia microti*, and *Anaplasma phagocytophila* in *Ixodes scapularis* ticks collected in Northern New Jersey. J Clin Microbiol. 2004;42:2799-801.
15. Giladi M, Maman E, Paran D, Bickels J, Comaneshter D, Avidor B, Varon-Graidy M, Ephros M, Wientroub S. Cat-scratch disease-associated arthropathy. Arthritis Rheum. 2005;52:3611-7.

Table 1. Selected demographic and epidemiological information and the *Bartonella* species sequenced from 14 non-immunocompromised individuals with a history of arthropod and animal contact.

Number	Sex	Age (Yrs)	State of residence	Occupational animal exposure	Daily contact with dogs/cats ¹	Contact with fleas/ticks ²	Self health assessment ³
1	Female	51	NC	Veterinarian	Y/Y	2/1	Chronically ill
2	Female	30	NC	Veterinary assistant	Y/N	3/3	Chronically ill
3	Female	48	NC	Animal health researcher	N/Y	4/4	Infrequently ill
4	Female	44	CO	Veterinarian	Y/Y	4/4	Infrequently ill
5	Female	53	VA	Veterinarian	Y/Y	3/3	Infrequently ill
6	Female	50	CA	Veterinarian	Y/Y	2/3	Chronically ill
7	Male	32	NC	Cattle rancher	Y/Y	3/3	Chronically ill
8	Female	33	VA	Veterinary assistant	Y/Y	2/2	Chronically ill
9	Female	48	CA	Veterinary assistant	Y/Y	4/4	Chronically ill

Table 1 (continued).

Number	Sex	Age (Yrs)	State of residence	Occupational animal exposure	Daily contact with dogs/cats ¹	Contact with fleas/ticks ²	Self health assessment ³
10	Female	53	CA	Veterinary assistant	Y/Y	2/4	Infrequently ill
11	Female	52	CA	Veterinary assistant	Y/Y	3/1	Chronically ill
12	Female	39	CA	Veterinarian	Y/Y	3/2	Chronically ill
13	Male	52	VA	Wildlife biologist	N/Y	No answer/3	Infrequently ill
14	Female	44	MN	Wildlife biologist	Y/Y	4/3	Chronically ill

¹ Reported as Y = yes, N = no with respect to the study participant's daily contact with dogs/cats.

² Reported as frequencies and defined as follows: 1 = daily, 2 = frequently (weekly), 3 = occasionally (monthly), 4 = almost never (yearly).

³ Self-health assessment: As part of the questionnaire, study participants were asked to rate their own health status: healthy, infrequently ill, or chronically ill.

Table 2. Symptoms reported by 14 immunocompetent individuals infected with *Bartonella henselae* or *Bartonella vinsonii* subsp. *berkhoffii* using a survey questionnaire.

Symptoms	Study participant number														Total (n=14)
	1	2	3	4	5	6	7	8	9	10	11	12	13	14	
Fatigue	+	+	-	+	+	+	+	+	+	+	+	+	+	+	13
Joint pain	+	+	-	+		+	+	+	-	+	+	+	+	U	10
Difficulty sleeping (insomnia)	+	+	-	-	+	-	+	+	+	+	+	+	-	-	9
Muscle pain	+	+	-	-		U	+	+	-	+	U	+	+	+	8
Difficulty remembering	+	+	-	-	+	-	+	+	+	+	+	-	-	U	8
Loss of sensation or numbness	+	+	+	-		+	-	+	-		+	+	-	U	7
Balance problems	+		-	-	+	+	+	+	-		+	+	-	-	7
Headache	+	+	-	-		+	+	+			-	+	+	U	7
Tremors	+		-	-		-	+	+	-	+	+	+	-	-	6
Irritability	+		-	-		-	+	+	+		+	-	-	+	6
Bowel or bladder dysfunction	+		-	+		+	-	+	-		+	-	+	-	6

Table 2 (continued).

Symptoms	Study participant number														Total (n=14)
	1	2	3	4	5	6	7	8	9	10	11	12	13	14	
Eye pain	+		-	+		+	+	+	-		-	-	-	-	5
Blurred vision	+		-	-		-	+	+	-	+	+	-	-	-	5
Sleepiness	+		-	-		-	+	-	-	+	+	-	-	+	5
Syncope or fainting episodes	+	+	+	-	+	+	-	-	-		-	-	-	-	5
Shortness of breath	+		-	+		-	+	+	-		+	-	-	U	5
Muscle weakness	+		-	-			+		-	+	+	+	-	U	5

+ = yes, - = No, Blank = No answer reported, U= unknown

Table 3. Serological and PCR results from blood collected at multiple time points from 14 individuals with frequent animal and arthropod contact. PCR results represent DNA extracted from the following samples: (1) directly from EDTA-anticoagulated blood and/or serum, (2) pre-enrichment liquid culture media following 7-day incubation, and (3) from bacterial isolates obtained from blood agar plates following sub-inoculation.

Day sample collected	<i>Bartonella</i> PCR test result			<i>Bartonella</i> IFA reciprocal titers		
	(1) Direct extraction from blood/serum	(2) Following 7-day pre-enrichment culture	(3) Blood agar plate isolate	<i>B. vinsonii berkhoffii</i>	<i>B. henselae</i>	<i>B. quintana</i>
Participant 1						
0	Neg ¹	Neg	<i>B. henselae</i> HI-like* ^b	N/A	N/A	N/A
50	<i>B. henselae</i> HI-like ^{2*b}	Neg	Neg	32	<32	<32
67	Neg	Neg	Neg	128	32	64
165	Neg	<i>B. henselae</i> ^s	Neg	<32	<32	<32
239	Neg	Neg	Neg	N/A	N/A	N/A
299	Neg	Neg	Neg	<32	<32	<32
351	Neg	Neg	Neg	256	64	<32
Participant 2						
0	Neg	Neg	Neg	<32	<32	<32
72	Neg	Neg	Neg	<32	<32	<32
89	<i>B. henselae</i> SA2-like ^{2*b}	Neg	Neg	<32	<32	<32
106	Neg	<i>B. henselae</i> SA2-like* ^b	Neg	128	64	64
Participant 3						
0	Neg	<i>B. henselae</i> SA2-like* ^b	Neg	512	128	128
44	Neg	Neg	Neg	1024	256	256
105	Neg	<i>B. henselae</i> SA2-like* ^b	Neg	512	256	256
319	Neg	Neg	Neg	512	256	256

Table 3 (continued).

Day sample collected	<i>Bartonella</i> PCR test result			<i>Bartonella</i> IFA reciprocal titers		
	(1) Direct extraction from blood/serum	(2) Following 7-day pre-enrichment culture	(3) Blood agar plate isolate	<i>B. vinsonii berkhoffii</i>	<i>B. henselae</i>	<i>B. quintana</i>
Participant 4						
0	Neg	<i>B. henselae</i> SA2-like* ^b	Neg	64	<32	64
33	Neg	Neg	Neg	N/A	N/A	N/A
Participant 5						
0	<i>B. vinsonii</i> subsp. <i>Berkhoffii</i> (Type II)* ^b	Neg	<i>B. vinsonii</i> subsp. <i>berkhoffii</i> (Type II)* ^b	<32	<32	<32
26	<i>Bh</i> (SA2-like) ^{3*s}	Neg	Neg	<32	<32	<32
Participant 6						
0	Neg	Neg	Neg	<32	<32	<32
35	<i>B. henselae</i> ³	<i>B. henselae</i> SA2-like* ^b	<i>B. henselae</i> SA2-like* ^s	<32	<32	<32
147	<i>B. henselae</i> SA2-like* ^s	Neg	Neg	<32	<32	<32
Participant 7						
0	Neg	<i>B. henselae</i> SA2-like* ^b , <i>B. vinsonii</i> subsp. <i>berkhoffii</i> (Type II)* ^b	Neg	32	<32	<32
31	Neg	Neg	Neg	128	<32	<32
Participant 8						
0	Neg	<i>B. henselae</i> ³	<i>B. henselae</i> SA2-like* ^s	<32	<32	<32
25	Neg	Neg	Neg	<32	<32	<32
183	Neg	<i>B. henselae</i> HI-like* ^s	Neg	<32	<32	<32
215	Neg	Neg	Neg	32	<32	<32

Table 3 (continued).

Day sample collected	<i>Bartonella</i> PCR test result			<i>Bartonella</i> IFA reciprocal titers		
	(1) Direct extraction from blood/serum	(2) Following 7-day pre-enrichment culture	(3) Blood agar plate isolate	<i>B. vinsonii</i> <i>berkhoffii</i>	<i>B. henselae</i>	<i>B. quintana</i>
Participant 9						
0	<i>B. vinsonii</i> subsp. <i>berkhoffii</i> (Type I)* ^b	<i>B. vinsonii</i> subsp. <i>berkhoffii</i> (Type I)* ^b , <i>B. henselae</i> ^b	Neg	N/A	N/A	N/A
82	Neg	Neg	Neg	256	128	128
Participant 10						
0	<i>B. vinsonii</i> subsp. <i>berkhoffii</i> (Type I)* ^s	Neg	<i>B. henselae</i> SA2-like* ^s	128	64	128
92	<i>B. vinsonii</i> subsp. <i>berkhoffii</i> (Type II) ³ * ^b	Neg	Neg	128	64	128
Participant 11						
0	Neg	Neg	Neg	32	<32	32
103	<i>B. vinsonii</i> subsp. <i>berkhoffii</i> (Type II)* ^b	Neg	Neg	<32	32	32
Participant 12						
0	Neg	Neg	Neg	64	32	32
193	Neg	<i>B. vinsonii</i> subsp. <i>berkhoffii</i> (Type II)* ^b	Neg	256	128	128
Participant 13						
0	Neg	<i>B. vinsonii</i> subsp. <i>berkhoffii</i> (Type II)* ^s	Neg	<32	<32	<32

Table 3 (continued).

Day sample collected	<i>Bartonella</i> PCR test result			<i>Bartonella</i> IFA reciprocal titers		
	(1) Direct extraction from blood/serum	(2) Following 7-day pre-enrichment culture	(3) Blood agar plate isolate	<i>B. vinsonii berkhoffii</i>	<i>B. henselae</i>	<i>B. quintana</i>
Participant 14						
0	Neg	Neg	Neg	<32	<32	<32
62	<i>B. henselae</i> SA2-like* ^{b&s}	<i>B. henselae</i> ^b	Neg	<32	<32	<32
146	Neg	Neg	Neg	<32	<32	<32

¹ Neg = Negative for *Bartonella spp.* by PCR

² *Bartonella henselae* Houston I-like (HI-like) or *Bartonella henselae* San Antonio-2 like (SA2-like).

³ Independent PCR from blood and serum identified a *Bartonella spp.*

* Identified by DNA sequencing.

^b = blood source for PCR or sequencing result.

^s = serum source for PCR or sequencing result.

N/A Serum not available for testing.

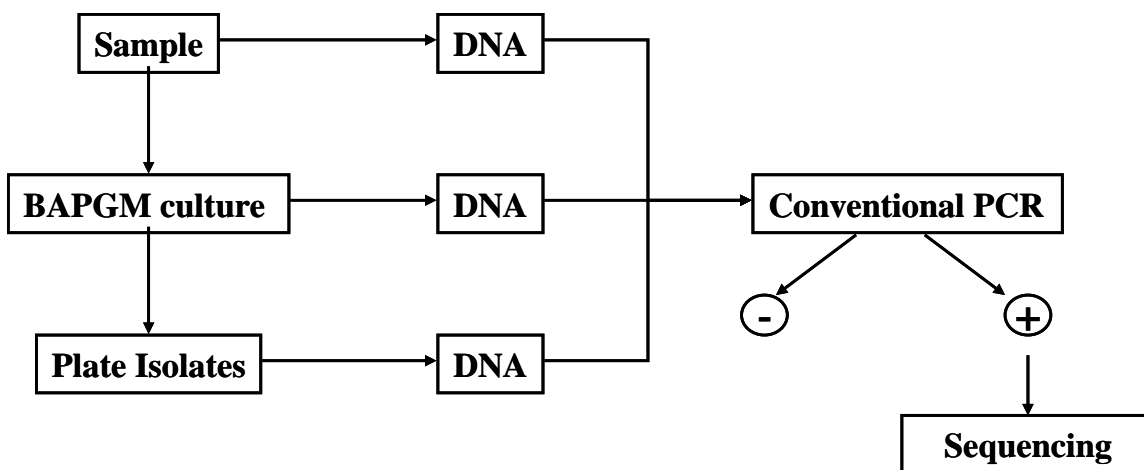

Figure 1. Schematic diagram that depicts sample processing and testing.

**Chapter 5. *Bartonella* DNA in the blood and lymph nodes of
Golden Retrievers with lymphoma and in healthy controls**

Internal and co-author review completed; currently awaiting reformatting and submission for publication at Journal of Veterinary Internal Medicine.

***Bartonella* DNA in the blood and lymph nodes of Golden Retrievers with lymphoma and in healthy controls**

Ashlee W. Duncan¹, Henry S. Marr¹, Adam J. Birkenheuer¹, Ricardo G. Maggi¹, Laurel E. Williams², Maria T. Correa³, and Edward B. Breitschwerdt¹

¹ Intracellular Pathogens Research Laboratory, Center for Comparative Medicine and Translational Research, North Carolina State University, College of Veterinary Medicine, Raleigh, North Carolina

² Department of Clinical Sciences, North Carolina State University, College of Veterinary Medicine, Raleigh, North Carolina

³ Department of Population Health and Pathobiology, North Carolina State University, College of Veterinary Medicine, Raleigh, North Carolina

Abstract

Lymphoma is a life-threatening hematopoietic cancer that results from the malignant transformation of lymphocytes, and it is the most common neoplastic process reported in dogs. Although the precise etiology of lymphoma is unknown, several breeds, including Golden Retrievers, are more likely to develop lymphoma, suggesting a strong breed predisposition. However, other factors, including environment, immunity, infection, and exposure to toxins, are also considered to be likely contributors to the evolution of the oncogenic process. In the current study, we hypothesized that the development of lymphoma in Golden Retrievers may be associated with chronic infection with one or more vector-borne pathogens, specifically *Bartonella*, *Anaplasma*, or *Ehrlichia* species. We

performed a matched, case-control study to determine the association of lymphoma and the presence of these vector-borne organisms in serum, blood, and lymph node aspirate samples. In addition, we determined the association of several purported risk factors for *Bartonella* infection and the presence of these vector-borne organisms. Using PCR analyses and DNA sequencing, single and co-infections with *B. henselae*, *B. elizabethae*, *B. quintana*, and/or *B. vinsonii (berkhoffii)* were detected in the blood and lymph nodes of Golden Retrievers with lymphoma and in healthy Golden Retrievers; no *Anaplasma* or *Ehrlichia* DNA was detected in samples from any dog. There were no differences in the molecular prevalence of *Bartonella* infections or in the specific *Bartonella* species detected in the blood or lymph nodes of dogs with lymphoma (5/28 dogs, 17.9%) when compared to the clinically healthy controls (10/56 dogs, 17.9%). To our knowledge, this is the first report in which *Bartonella* DNA was detected in the lymph nodes of clinically healthy dogs or in dogs with lymphoma. Consistent with earlier reports, a significantly higher proportion of healthy Golden Retrievers were receiving monthly acaricide treatments (2.6 times higher), when compared to dogs with lymphoma. In addition, Golden Retrievers that were PCR positive for *Bartonella* species had prior tick exposure (odds ratio = 3.4) and were classified by their owners as indoor/outdoor dogs (odds ratio = 3.1), when compared to dogs that were PCR negative for *Bartonella* species. Based on these data, longitudinal studies should be conducted to determine whether *Bartonella* species can be transmitted by ticks, whether lymphatic infection is persistent, or whether these bacteria may contribute to the development of lymphoma.

Introduction

Lymphoma is a common, life-threatening hematopoietic cancer of dogs, which results from the malignant transformation of lymphocytes. Canine lymphoma has been estimated to affect between 1.3 and 3.3% of dogs each year (Teske 1994) and accounts for up to 25% of canine neoplasia reported by some veterinary institutions (Hansen et al., 2004; Vail et al., 2001). As with other forms of cancer, the etiology of lymphoma is thought to be multi-factorial. Although the precise etiology of canine lymphoma is unknown, it is hypothesized that various genetic, environmental, immunological, toxic, and infectious factors may all play important roles in etiopathogenesis (Fan et al., 2005; Lurie et al., 2004).

Several environmental risk factors have been associated with canine lymphoma, such as exposure to phenoxy-acetic acid herbicides (Hayes et al., 1995), organic solvents (Gavazza et al., 2001), and magnetic fields (Reif et al., 1995). Recent studies have focused on the identification of possible predisposing genetic factors that may contribute to the development of cancer. When compared to the general hospital population treated for lymphoma at Tufts University School of Veterinary Medicine, Golden Retrievers were shown to be at an increased risk for the development of lymphoma (relative risk = 2.8, 95% confidence interval = 1.8 to 4.2, $p = 0.0003$) (Moore et al., 2001). Breed-specific research has demonstrated that Golden Retrievers develop significantly ($p < 0.001$) more B-cell and T-cell lymphoma when compared to other dog breeds (Modiano et al., 2005). Further, unique cytogenetic abnormalities (i.e., chromosomal gains and losses) have been

identified in Golden Retrievers with lymphoma, changes that were recognized significantly ($p < 0.001$) less frequently or not at all in other dog breeds with lymphoma (Modiano et al., 2005). Additionally, Golden Retrievers have an earlier (1 year earlier, $p < 0.001$) age of onset for lymphoma, along with a smaller standard deviation of the mean age at onset, when compared to other breed groups (Modiano et al., 2007). While genetics is certainly a prominent factor contributing to lymphoma in Golden Retrievers, it is hypothesized that other interactions between environmental and immunological factors are likely contributors to the oncogenic process.

The 1998 Golden Retriever Club of America-National Health Survey demonstrated a statistically significant ($p \leq 0.05$) decrease in the frequency of lymphoma among dogs that had been treated with flea and tick prevention products (Glickman et al., 2000). However, to date, no studies have been conducted to determine whether chronic infection with a vector-borne organism might contribute to the development of lymphoma in dogs. On rare occasions, *E. canis* infection has been associated with the development of clonally expanded T-cell populations in dogs without overt lymphoid malignancies; however, the significance of these lymphocyte populations is currently unknown, and whether these dogs were co-infected with a *Bartonella* species was not established (Avery et al., 2004; Burnett et al., 2003; Codner et al., 1986; Vernau et al., 1999).

During the past decade, researchers have provided an expanding body of evidence to support a potential role for infectious agents such as viruses, mycoplasma, bacteria, and protozoa, as cofactors in the development of cancer in humans (Lax et al., 2002). In fact, the World Health Organization recently estimated that one-fifth (20%) of all cancers

worldwide are caused by chronic infection with a virus, bacteria, or protozoa (WHO 2006). It is well established that viruses and retroviruses cause malignant transformation of DNA that can result in the development of neoplasia; examples include the association of Epstein-Barr virus with Burkitt's lymphoma, Hodgkin's disease, lymphomas, and other lymphoproliferative diseases in humans (Serraino et al., 2005), as well as malignancies associated with human immunodeficiency viral infection including Kaposi's sarcoma and non-Hodgkin's lymphoma (CDC 1993). Similar findings have been observed in cats infected with feline leukemia virus that develop lymphoma (Ettinger 2003) and dogs infected with *Spirocerca lupi* that may subsequently develop esophageal sarcomas (Ranen et al., 2004). A role for bacteria in human carcinogenesis was discovered when chronic infection with *Helicobacter pylori* was associated with an increased risk of gastric adenocarcinoma and mucosa-associated lymphoid tissue (MALT) lymphoma (Parsonnet et al., 1991; Wotherspoon et al., 1991). Additionally, other links between chronic bacterial infections and oncogenesis have been described, such as *Salmonella typhi* and hepatobiliary carcinoma, *Campylobacter jejuni* and MALT lymphoma, and *Chlamydia psittaci* and ocular lymphoma (Caygill et al., 1995; Ferreri et al., 2004; Lecuit et al., 2004). Based on a plausible molecular pathogenesis of endothelial cell proliferation and angiogenesis, several *Bartonella* species, such as *B. quintana* and *B. henselae*, are considered to be bacterial pathogens capable of causing or contributing to carcinogenesis (Kempf et al., 2002; Lax et al., 2002).

Bacteria of the genus *Bartonella* are fastidious, pleomorphic, gram-negative, vector-borne (fleas, lice, sandflies, biting flies, and potentially ticks) aerobic bacilli with

more than 20 described species or subspecies (Boulouis et al., 2005; Breitschwerdt et al., 2000; Chomel et al., 2003; Chomel et al., 2004; Chomel et al., 2006; Chomel 2000; Dehio 2004; Foucault et al., 2006). *Bartonella* are highly adapted bacteria that maintain persistent intracellular infections in a wide variety of cell types in humans and animals (Breitschwerdt et al., 2000; Brouqui et al., 1999; Dehio 2001; Kordick et al., 1995; Maurin et al., 1997; Dehio 2003; Dehio 2004; Kempf et al., 2002; Lax et al., 2002; Kempf et al., 2005; Kyme et al., 2005; Resto-Ruiz et al., 2002; Seubert et al., 2002; Vermi et al., 2006). Recognized as important emerging pathogens in human and veterinary medicine, *Bartonella* species have been implicated in several disease processes in dogs, such as endocarditis, granulomatous lymphadenitis, peliosis hepatis, and granulomatous hepatitis (Breitschwerdt et al., 1995; Gillespie et al., 2003; Kitchell et al., 2000; Morales et al., 2007; Pappalardo et al., 2000).

In the current study, we hypothesized that the development of lymphoma in Golden Retrievers may be associated with chronic infection with one or more vector-borne pathogens, specifically *Bartonella*, *Anaplasma*, or *Ehrlichia* species. We performed a matched, case-control study to determine the association of lymphoma with the presence of these vector-borne organisms in serum, blood, and lymph node aspirate samples. In addition, we determined the association of several purported risk factors for *Bartonella* infection and the presence of these organisms.

Materials and methods

Study participants. Study participants were identified by veterinarians across the United States, and samples were collected between November 2004 and December 2006. To be included in the study, a complete sample set was required, including a serum sample for indirect immunofluorescent antibody assays (IFA) and enzyme-linked immunosorbent assays (ELISA), along with an EDTA-anticoagulated whole blood sample and at least one lymph node aspirate for DNA extraction and PCR analysis. Participation required informed consent from each owner indicating he/she understood the goals and procedures for this study. Protocols and procedures were reviewed and approved by the NCSU-Institutional Animal Care and Use Committee (protocol number 05-048-B). Testing was conducted by personnel at the Intracellular Pathogens Research Laboratory at North Carolina State University (IPRL-NCSU), unless otherwise noted.

Case dogs. Golden Retrievers, diagnosed with lymphoma by a board-certified pathologist using cytological or histopathological methods, were evaluated as case dogs. Our minimum entry criteria for a case included no prior diagnosis or treatment for lymphoma, no antibiotic administration within 14 days prior to sample collection (or 30 days for azithromycin), and no treatment with corticosteroids or other immunosuppressive drugs within 14 days of sample collection.

Control dogs. For each Golden Retriever with lymphoma, two healthy Golden Retrievers were sampled in a similar manner and served as unaffected controls. All controls were matched by geographic region (resided within a 100-mile radius of the

respective case dog), age (\pm 24 months), and when possible, by gender. Controls were clinically healthy and lacked evidence of lymphadenopathy, as determined by a physical assessment by their veterinarian. Control dogs had not received any immunosuppressive drugs or antibiotics within 14 days prior to sample collection (or 30 days for azithromycin).

Sample collection. Serum, EDTA-anticoagulated whole blood, and lymph node aspirate(s) were submitted to the IPRL-NCSU. The protocol for obtaining lymph node aspirates was as follows: (1) before obtaining the aspirate, 1 mL of sterile saline was injected into a sterile, unopened Vacutainer™ red-topped tube, (2) the lymph node was aspirated using an 18- to 20-gauge needle and 12cc syringe for adequate suction, (3) using the same needle and syringe, the saline was drawn from the tube into the syringe containing the aspirate and rinsed three to five times to wash the lymphoid cells from the needle into the collection tube; and (4) the aspiration process was repeated as needed using a new needle and tube for each additional lymph node. We requested that multiple lymph nodes be sampled due to the difficulty associated with aspirating a lymph node from a dog without lymphadenopathy; collection of multiple samples increased the opportunity of having at least one sample with measurable DNA for PCR analyses.

Questionnaire. Owners of case and control dogs completed a self-administered questionnaire addressing various conditions that were considered potential risk factors for *Bartonella*, *Anaplasma*, and *Ehrlichia* infection, such as rural/suburban/urban residence and flea/tick/cat exposure. Housing conditions were subjectively assessed by the owners

based on three categories: indoor only, outdoor only, or indoor/outdoor. Owners were also queried about the use and regularity of acaricide application, along with the dog's travel history. A copy of the questionnaire is available by request through the corresponding author.

Serology. Serum samples were analyzed for IgG antibodies to *B. henselae* and *B. vinsonii (berkhoffii)* antigens using an IFA procedure as previously described (Solano-Gallego et al., 2004). Serum samples were also analyzed for *E. canis* IgG antibodies using an IFA procedure that has been described elsewhere (Solano-Gallego et al., 2004; Suksawat et al., 2000). Reciprocal titers greater than or equal to 64 were considered seroreactive.

Serum samples were screened for the presence of *Dirofilaria immitis* antigens, antibodies to *E. canis*, antibodies to *Anaplasma phagocytophilum*, and antibodies to *Borrelia burgdorferi* using a commercial assay kit (Canine SNAP® 4Dx™ Test; IDEXX Laboratories, Westbrook, ME).

Preparation of DNA. Total DNA was isolated from blood samples and lymph node aspirates using the QIAamp DNA Blood Mini-Kit (QIAGEN Inc., Valencia, CA, USA) according to the manufacturer's instructions. After extraction, DNA concentration and quality were quantified by spectrophotometry (NanoDrop™ Technologies, Wilmington, DE).

PCR controls. In order to prevent PCR amplicon contamination, DNA extraction, reaction setup, PCR amplification, and amplicon detection were all performed

in separate areas. Positive and negative controls were used in all processing steps, including the DNA extraction. Amplification of a fragment of the glyceraldehyde-3-phosphodehydrogenase (GAPDH) pseudogene was performed as previously described to demonstrate integrity of the DNA and the absence of PCR inhibitors (Birkenheuer et al., 2003). All samples had to be GAPDH-PCR positive to be included in the subsequent PCR analyses for *Bartonella*, *Anaplasma*, or *Ehrlichia* species.

Screening of samples for Bartonella DNA. All blood and lymph node aspirate samples were screened for the presence of *Bartonella* species using two separate PCR assays. The first screening level included a real-time PCR method with minor modifications to a previously described technique (Maggi et al., 2005a; Maggi et al., 2005b); this PCR amplified an approximate 120-base pair fragment of the 16S-23S intergenic transcribed spacer (ITS) region, and primers are shown in Table 1. PCR conditions were optimized using a 50- μ L reaction volume containing 25 μ L of 2X SYBR GREEN® Master Mix (Applied Biosystems, Foster City, CA), 15 pmol of each primer (Table 1), 19 μ L of molecular grade water, and 1 to 5 μ L of DNA template, according to the DNA concentration determined for each sample (5 to 100 ng of DNA/reaction). Real-time reactions were performed using a BioRad iCycler® iQ Real-Time PCR System (Hercules, CA) and thermal cycling conditions of 95°C for 5 min, followed by 45 cycles of 95°C for 30 s, 56°C for 30 s, 72°C for 30 s, and a final extension of 72°C for 5 min. In addition to melt-curve analysis, PCR products were visualized using 2.5% agarose gel electrophoresis containing 0.2 μ g of ethidium bromide/mL under transilluminating ultraviolet light.

Negative controls were prepared using DNA extracted from EDTA-anticoagulated whole blood samples obtained from a *Bartonella*-negative Golden Retriever. Real-time PCR positive controls were prepared using the same DNA extracts (as the negative control) spiked with plasmids containing a partial ITS sequence of *B. henselae* San Antonio 2 strain (GenBank Accession number: AF369529), *B. quintana* Fuller strain (M11927), or *B. vinsonii* (*berkhoffii*) Type I (AF167988). The limit of detection for the ITS assay was determined to be five copies of target-containing plasmid per reaction.

The second PCR screen for *Bartonella* DNA utilized a conventional PCR targeting the *Bartonella* Pap31 gene as described elsewhere (Maggi et al., 2005b), with minor modifications. Master mixes were prepared in 50 μ L-reaction volumes as follows: 25 μ L of 2X TaKaRa Premix Ex Taq (Fisher Scientific), 15 pmol of each primer, 19 μ L of molecular grade water, and 1 to 5 μ L of DNA template, according to the DNA concentration determined for each sample (5 to 100 ng of DNA/reaction). Amplification was performed in an Eppendorf® MasterCycler® ep gradient (Westbury, NY). Negative and positive controls were prepared as described for the ITS PCR; however, plasmids used for positive controls contained a partial Pap31 sequence for *B. henselae* San Antonio 2 strain (GenBank Accession number: DQ529248). The limit of detection for the conventional Pap31 method is two copies of target-containing plasmid per reaction.

Species-specific real-time PCR reactions. Samples that were positive for *Bartonella* DNA using either of the PCR screening assays were further analyzed using real-time PCR primers designed to detect co-infections with more than one *Bartonella*

species in the same DNA sample. These primers are shown in Table 1. Both ITS and Pap31 gene targets were utilized. In an attempt to elucidate co-infections with more than one *Bartonella* species, the first species-specific ITS primer was designed to detect *B. henselae* specifically, while the second ITS primer was designed to detect *Bartonella* species other than *B. henselae*. Reaction master mixes, cycling conditions, methods of amplicon detection, and negative and positive controls were the same as those used for the genus-specific amplification. The limits of detection for these species-specific assays were determined to be five copies of target-containing plasmid per reaction.

Conventional PCR for Anaplasma and Ehrlichia. All blood and lymph node aspirate samples were tested for the presence of *Anaplasma* and *Ehrlichia* DNA using 16S rRNA as a gene target. As shown in Table 2, *Anaplasma* and *Ehrlichia* genus-level screening primers targeted a region of the 16s rRNA gene. Reaction master mixes were prepared in 25 μ L-reaction volumes with 1 to 5 μ L of DNA template as described above for *Bartonella* PCR. Using an Eppendorf® MasterCycler® epS gradient, cycling conditions were 95°C for 10 s, followed by 55 cycles of 94°C for 15 s, 63.8°C for 15 s, 72°C for 18 s, and a final extension of 72°C for 2 min. PCR products were visualized using 2% agarose gel electrophoresis containing 0.2 μ g of ethidium bromide/mL under transilluminating ultraviolet light.

DNA extracted from the whole blood of a purpose-bred, specific-pathogen-free dog that was consistently *Anaplasma/Ehrlichia* PCR-negative was used as a negative control. Plasmid clones of a partial sequence of *E. canis* 16S rRNA (GenBank Accession number: CP000107), resuspended in *Anaplasma/Ehrlichia*-negative canine DNA, were used as a

positive control, and the limit of detection is five copies of the target-containing plasmid per reaction.

Sequencing of amplicons. All amplicons were sequenced directly (Davis Sequencing, Davis, CA) to identify species; in most instances, the amplicons were sequenced in both forward and reverse directions. Sequence analysis and alignment with GenBank sequences were performed using AlignX software (Vector NTI Suite 6.0, InforMax, Inc., Frederick, MD, USA). Based on the *Bartonella* PCR primers utilized, amplicons were typed to the genus and species level only. Strain differentiation was not possible due to the small amplicon size generated by real-time PCR for the ITS region. Further, strain differentiation cannot be established by Pap31 gene sequence, as no sequence differences are found in the two *B. henselae* strains most commonly detected in dogs (Houston 1 and San Antonio 2).

Statistical analyses. In several instances, multiple lymph node aspirates, collected at a single sampling point, were submitted. All samples were analyzed for *Bartonella* DNA. If any aspirate and/or blood sample contained *Bartonella* DNA, the dog was included as a positive. If all aspirates and blood samples submitted for a dog were negative for *Bartonella* DNA, a negative result was recorded.

Descriptive statistics were obtained for the following variables: exposure to ticks coded as no/yes; exposure to fleas and exposure to cats coded as no/yes; regular acaricide use also coded as no/yes; indoor/outdoor status versus indoor only; and urban/suburban residence as opposed to rural residence. Putative risk factors were evaluated using two

different statistical models: one model assessed the differences between dogs with lymphoma compared to healthy controls, while the second model considered the differences between dogs with a PCR-positive result for *Bartonella*, *Anaplasma*, and/or *Ehrlichia* compared to PCR-negative dogs. The second outcome variable, *Bartonella*, *Anaplasma*, and/or *Ehrlichia*-PCR status was defined as negative or positive and was created by combining the results of blood and lymph node aspirate PCR analyses. Dogs were considered to be positive for *Bartonella*, *Anaplasma*, and/or *Ehrlichia* if either the blood and/or lymph node aspirate sample was PCR positive for *Bartonella*, *Anaplasma*, and/or *Ehrlichia* species DNA.

We developed a conditional logistic regression main-effects only model (Egret[®], Cytel Inc., Cambridge, MA) and utilized a hierarchical backward elimination algorithm to determine the association between (1) lymphoma status and the previously described variables and (2) the association between *Bartonella*, *Anaplasma*, and/or *Ehrlichia* PCR-status and the previously described variables. As an alternative statistical analysis, we evaluated the data using the Mantel-Haenszel method for multiple matched controls to test whether the proportions of dogs with lymphoma and healthy control dogs differed with respect to the previously described risk factors; this method analyzes the proportions for only one variable at a time (Fleiss 1981). Matching, as described previously, was performed by geographic region, age, and gender. Statistical significance was considered at a p -value of ≤ 0.05 .

Results

Study participants. Complete sample sets were submitted for 28 Golden Retrievers with lymphoma and their 56 age-, gender-, and geographically matched, healthy, Golden Retriever controls. Samples were submitted from veterinarians across the United States: seven cases from North Carolina; four cases from Virginia; three cases each from Connecticut and Florida; two cases each from New York and Texas, and one case each from California, Illinois, New Jersey, Ohio, Oregon, Pennsylvania, and Washington.

Of the 28 dogs with lymphoma, 12 were female (10 spayed, 1 intact, 1 unspecified) and 16 were male (14 neutered, 2 intact); median age was 7.5 years (standard deviation, 2.3 years; range, 3 to 12 years). Of the 56 control dogs, 26 were female (17 spayed, 9 intact) and 30 were male (26 neutered, 4 intact); median age was 6.8 years (standard deviation, 2.7 years; range, 2 to 13 years). No differences were observed between the dogs with lymphoma and the healthy controls when evaluating age, gender, or spay/neuter status; further, no differences in travel history were noted.

Serology. Of the 84 Golden Retrievers surveyed, four (4.8%) were seroreactive to *B. henselae* antigens, and two (2.4%) were seroreactive to *B. vinsonii (berkhoffii)* antigens. Only one of 28 dogs with lymphoma (3.6%) was seroreactive to both *B. henselae* and *B. vinsonii (berkhoffii)* with reciprocal IFA titers of 2,048 and 64, respectively. For the healthy controls, three of 56 (5.4%) dogs were seroreactive to *B. henselae* antigens with reciprocal titers of 64 or 128, and one healthy dog (1.8%) was also

seroreactive to *B. vinsonii (berkhoffii)* at a reciprocal titer of 128. The remaining 80 dogs were not seroreactive to *B. henselae* and *B. vinsonii (berkhoffii)* antigens.

Of the 82 dogs surveyed for which there was sufficient serum for ELISA testing, three dogs with lymphoma (3/27, 11.1%) and six control dogs (6/55, 10.9%) were seroreactive to *Borrelia burgdorferi*; all dogs had either resided in or regularly traveled to northeastern Lyme-endemic states, including Connecticut, Delaware, or New York. One dog with lymphoma (1/27, 3.7%) and four healthy dogs (4/55, 7.3%) were seroreactive to *A. phagocytophilum* antigens, and all five currently reside or have previously resided in Connecticut, an *A. phagocytophilum*-endemic state. *Dirofilaria immitis* antigens were not found in any of the 82 dogs. Antibodies to *Ehrlichia canis* were not detected by IFA (n = 84) or by ELISA (n = 82) in any serum sample collected from dogs with lymphoma or in the healthy control dogs.

Based on the results obtained, there was no association between the evidence of vector-borne infection as determined by serologic testing and lymphoma.

***Bartonella* PCR analyses.** Five of 28 dogs with lymphoma (17.9%) and 10 of 56 healthy control dogs (17.9%) were positive for *Bartonella* using PCR analyses. Detailed results of all *Bartonella* PCR assays from positive dogs are presented in Table 3. Regardless of case/control status, *Bartonella* species were detected more frequently in lymph node aspirates than in blood samples. *Bartonella* DNA was detected in two blood samples from dogs with lymphoma and in two blood samples from the healthy Golden Retrievers; in contrast, *Bartonella* DNA was detected in five and eight lymph node aspirates from dogs with lymphoma and healthy Golden Retrievers, respectively.

PCR controls. Amplicon contamination was not detected in any of the negative control samples at any stage of processing or at any time during the study. As determined by the amplification of GAPDH, no PCR inhibitors were present in any of the DNA samples that were negative by PCR testing.

Anaplasma and Ehrlichia PCR analyses. All blood and lymph node aspirate samples screened for *Anaplasma* and *Ehrlichia* DNA were negative. Additionally, amplicon contamination was not detected in any of the negative controls at any time, and no PCR inhibitors were present as determined by the successful amplification of GAPDH in all samples.

Questionnaire. Due to the distribution of the data, we were unable to develop a conditional logistic regression model to evaluate the association between lymphoma status and the proposed risk variables. Using the Mantel-Haenszel method for multiple matched controls, no differences were observed in the proportions of dogs with lymphoma and previous tick exposure; however, when considering the monthly use of acaricide as reported by the owners, the proportion of healthy control dogs receiving acaricide was approximately 2.6 times higher ($p < 0.05$) than dogs with lymphoma. Further, the proportion of healthy dogs classified by their owners as indoor/outdoor dogs was approximately 2.3 times higher ($p < 0.05$) than dogs with lymphoma.

In the second statistical model, which evaluated *Bartonella*-PCR positive status as the factor of interest, different variables were significant. Similar to previous research, which defined putative risk factors for *B. vinsonii* (*berkhoffii*) seroreactivity (Pappalardo et

al., 1997), tick exposure and owner's classification of indoor/outdoor status were also risk factors for the presence of detectable *Bartonella* DNA in the current study. When compared to dogs that were negative for *Bartonella* DNA, the results of conditional regression model suggest that dogs that were PCR positive for *Bartonella* DNA were more likely to have previous tick exposure (odds ratio: 3.4; 95% confidence interval for the odds ratio: 0.7 to 17.1) and were classified by their owners as indoor/outdoor dogs (odds ratio: 3.1; 95% confidence interval for the odds ratio: 0.9 to 10.3). Although statistically significant in the model, it should be noted that the lower side of the 95% confidence intervals for both of the odds ratio estimates were marginal in value and is likely associated with the small sample size and large variability in the data.

Discussion

Using PCR and DNA sequencing, we detected four different *Bartonella* species in blood and lymph node aspirates of the Golden Retrievers surveyed: *B. henselae*, *B. elizabethae*, *B. quintana*, and *B. vinsonii (berkhoffii)*. Although there were no differences in the molecular prevalence of *Bartonella* species between Golden Retrievers with lymphoma (17.9%) when compared to age-, gender-, and geographically matched, healthy Golden Retrievers (17.9%), the high molecular prevalence found in these dogs was unexpected. In addition, similar *Bartonella* species were sequenced from dogs with lymphoma and from healthy Golden Retrievers. In contrast to the high molecular prevalence of *Bartonella* species, no *Anaplasma* or *Ehrlichia* species DNA was detected in

blood or lymph node aspirate samples from the Golden Retrievers surveyed. Further, seroreactivity to *A. phagocytophilum* and *Borrelia burgdorferi* was detected only in dogs that had previously resided in or regularly traveled to Lyme-endemic regions of the northeastern United States, suggesting that these regionally defined pathogens would be less likely candidates if vector-borne organisms contribute to the development of lymphoma. There was also no difference in seroreactivity to *A. phagocytophilum* and *Borrelia burgdorferi* among dogs with lymphoma and healthy dogs.

No differences were observed in the proportions of dogs with lymphoma and *Bartonella* DNA or between dogs with lymphoma and previous tick exposure. As executed, this study had a power ($1 - \beta = 0.80$) to detect a 20% difference in the presence of *Bartonella* DNA in dogs with lymphoma and healthy control dogs; the fact that we did not detect a difference between the proportions of *Bartonella* DNA in the two groups would suggest that *Bartonella* infection is not a major co-factor in the development of lymphoma in Golden Retrievers. However, when considering the monthly use of acaricide as reported by the owners, the proportion of healthy control dogs receiving acaricide was approximately 2.6 times higher ($p < 0.05$) than acaricide use reported in dogs with lymphoma. This finding is similar to observations in the 1998 Golden Retriever Club of America-National Health Survey, which indicated a decrease ($p \leq 0.05$) in the frequency of lymphoma among dogs treated with flea and tick prevention products (Glickman et al., 2000). These results suggest that another tick-associated factor may be involved in the development of lymphoma within this breed.

Prior to the development of PCR, diagnosis of *Bartonella*, *Anaplasma*, or *Ehrlichia* infection was dependent on microbiological isolation, blood smear examination, or serological analysis using ELISA, IFA, or western immunoblotting. However, these methods of diagnosis can be relatively insensitive when compared to molecular-based assays, and in certain instances only confirm prior exposure (serology) as compared to active infection (DNA detection by PCR). In the present study, seroreactivity by IFA did not correlate with the presence or absence of *Bartonella*, as detected by PCR amplification and DNA sequencing. Possible explanations include: (1) recent infection with inadequate time to develop an IgG antibody response, (2) impaired ability of Golden Retrievers to develop an appropriate antibody response, (3) efficient evasion or lack of immune recognition of *Bartonella* species in some individuals, (4) inappropriate *Bartonella* strain used as antigen in serological analyses, or (5) lack of sensitivity of the IFA assay. The lack of correlation between serology and PCR and/or blood-culture positive patients has been demonstrated in humans infected with *B. henselae*, *B. quintana*, and *B. vinsonii* (*berkhoffii*) (Brouqui et al., 1999; Drancourt et al., 1996; La Scola et al., 1999, Breitschwerdt et al. 2007) and in rodents infected with *Bartonella* species (Kosoy et al., 1997; Kosoy et al., 2004). Based on recent publications from our laboratory, additional studies will be necessary to define discrepancies between *Bartonella* serology and PCR or isolation in dogs and in human beings infected with *Bartonella* species (Breitschwerdt et al., 2007; Diniz et al., 2007; Duncan et al., 2007).

Although other breed-associated serological and molecular epidemiological surveys are clearly needed, the relatively frequent detection of *Bartonella* DNA in blood samples

and lymph node aspirates from clinically healthy Golden Retrievers in this study suggests that previous case reports describing the detection of *Bartonella* DNA in the tissues of diseased dogs should be interpreted with caution. The association of *B. henselae* with peliosis hepatis (Kitchell et al., 2000), granulomatous lymphadenitis (Morales et al., 2007; Pappalardo et al., 2000), and granulomatous hepatitis (Gillespie et al., 2003) is logical based on the association of this bacterial species with peliosis hepatis and a granulomatous inflammatory response in humans (Koehler et al., 1997; Liston et al., 1996). However, the current study emphasizes the need for appropriate controls for each pathological lesion in which *Bartonella* infection is thought to be a causative agent or co-factor.

To our knowledge, this is the first report in which *Bartonella* DNA was detected in the lymph nodes of healthy dogs or dogs with lymphoma. Further, *Bartonella* species were detected more frequently in lymph node aspirates than in whole blood samples. It is possible that following intra-dermal inoculation of a *Bartonella* species by an arthropod vector or a scratch, the organisms enter dendritic cells, traffic to regional lymph nodes, and induce a chronic infection within the lymphatic system (Vermi et al., 2006). Research is currently underway to determine the precise location of *Bartonella* within lymph nodes using immunohistochemistry, *in situ* hybridization, flow cytometry, and confocal microscopy. In the context of disease causation, it is important to note that this study did not incorporate a longitudinal design, and therefore, the authors are unaware of whether the healthy control dogs seroconverted, subsequently developed *Bartonella*-related disease manifestations, were treated by their veterinarians, or progressed to lymphoma. Based on these data, longitudinal studies should be conducted to determine whether *Bartonella*

species can be transmitted by ticks, whether lymphatic infection is persistent, or whether these bacteria may contribute to the development of lymphoma.

Acknowledgements

The authors gratefully acknowledge the assistance of the veterinarians who provided samples and the owners who allowed participation of their dogs in this study. Our appreciation is extended to Valerie Hendrickson, Dr. Pedro Paulo Diniz, Julie Bradley, Dr. Hunter Blanton, Dr. Andrew Vaughan, Dr. Neil Marrinan, Dr. Julie Levy, Natalie Cherry, and the Golden Retriever Club of America for their assistance with the study. This research was funded in part by the American Kennel Club-Canine Health Foundation, Bayer Animal Health, the Golden Retriever Foundation, IDEXX Laboratories, and the State of North Carolina.

References

Avery, P.R., Avery, A.C., 2004. Molecular methods to distinguish reactive and neoplastic lymphocyte expansions and their importance in transitional neoplastic states. *Vet. Clin. Path.* 33 (4), 196.

Birkenheuer, A.J., Levy, M.G., Breitschwerdt, E.B., 2003. Development and evaluation of a seminested PCR for detection and differentiation of *Babesia gibsoni* (Asian genotype) and *B. canis* DNA in canine blood samples. *J. Clin. Microbiol.* 41 (9), 4172-4177.

Boulouis, H.J., Chang, C.C., Henn, J.B., Kasten, R.W., Chomel, B.B., 2005. Factors associated with the rapid emergence of zoonotic *Bartonella* infections. *Vet. Res.* 36 (3), 383-410.

Breitschwerdt, E.B., Maggi, R.G., Duncan, A.W., Nicholson, W.L., Hegarty, B.C., Woods, C.W., 2007. Isolation of *Bartonella henselae* and *Bartonella vinsonii* subspecies *berkhoffii* from the blood of immunocompetent persons with arthropod and occupational animal contact. In press at Emerging Infectious Diseases.

Breitschwerdt, E.B., Kordick, D.L., 2000. *Bartonella* infection in animals: Carriership, reservoir potential, pathogenicity, and zoonotic potential for human infection. Clin. Microbiol. Rev. 13 (3), 428-438.

Breitschwerdt, E.B., Kordick, D.L., Malarkey, D.E., Keene, B., Hadfield, T.L., Wilson, K., 1995. Endocarditis in a dog due to infection with a novel *Bartonella* subspecies. J. Clin. Microbiol. 33 (1), 154-160.

Brouqui, P., Lascola, B., Roux, V., Raoult, D., 1999. Chronic *Bartonella quintana* bacteremia in homeless patients. N. Engl. J. Med. 340 (3), 184-189.

Burnett, R.C., Vernau, W., Modiano, J.F., Olver, C.S., Moore, P.F., Avery, A.C., 2003. Diagnosis of canine lymphoid neoplasia using clonal rearrangements of antigen receptor genes. Vet. Pathol. 40 (1), 32-41.

Caygill, C.P., Braddick, M., Hill, M.J., Knowles, R.L., Sharp, J.C., 1995. The association between typhoid carriage, typhoid infection and subsequent cancer at a number of sites. Eur. J. Cancer Prev. 4 (2), 187-193.

Centers for Disease Control and Prevention (CDC), 1993. 1993 revised classification system for HIV infection and expanded surveillance case definition for AIDS among adolescents and adults. JAMA 269 (6), 729-730.

Chomel, B.B., 2000. Cat-scratch disease. Rev. Sci. Tech. 19 (1), 136-150.

Chomel, B.B., Boulouis, H.J., Breitschwerdt, E.B., 2004. Cat scratch disease and other zoonotic *Bartonella* infections. J. Am. Vet. Med. Assoc. 224 (8), 1270-1279.

Chomel, B.B., Boulouis, H.J., Maruyama, S., Breitschwerdt, E.B., 2006. *Bartonella* spp. in pets and effect on human health. Emerg. Infect. Dis. 12 (3), 389-394.

Chomel, B.B., Kasten, R.W., Sykes, J.E., Boulouis, H.J., Breitschwerdt, E.B., 2003. Clinical impact of persistent *Bartonella* bacteremia in humans and animals. Ann. N. Y. Acad. Sci. 990 267-278.

Codner, E.C., Farris-Smith, L.L., 1986. Characterization of the subclinical phase of ehrlichiosis in dogs. J. Am. Vet. Med. Assoc. 189 (1), 47-50.

Dehio, C., 2004. Molecular and cellular basis of *Bartonella* pathogenesis. Annu. Rev. Microbiol. 58 365-390.

- Dehio, C., 2003. Recent progress in understanding *Bartonella*-induced vascular proliferation. *Curr. Opin. Microbiol.* 6 (1), 61-65.
- Dehio, C., 2001. *Bartonella* interactions with endothelial cells and erythrocytes. *Trends Microbiol.* 9 (6), 279-285.
- Diniz, P.P.V.P., Maggi, R.G., Schwartz, D.S., Cadenas, M.B., Bradley, J.M., Hegarty, B.C., Breitschwerdt, E.B., 2007. Canine bartonellosis: Serological and molecular prevalence in Brazil and evidence of co-infection with *Bartonella henselae* and *Bartonella vinsonii* subsp. *berkhoffii*. In press at Veterinary Research.
- Drancourt, M., Moal, V., Brunet, P., Dussol, B., Berland, Y., Raoult, D., 1996. *Bartonella (Rochalimaea) quintana* infection in a seronegative hemodialyzed patient. *J. Clin. Microbiol.* 34 (5), 1158-1160.
- Duncan, A.W., Maggi, R.G., Breitschwerdt, E.B., 2007. A combined approach for the enhanced detection and isolation of *Bartonella* species in dog blood samples: Pre-enrichment liquid culture followed by PCR and subculture onto agar plates. *J. Microbiol. Methods.* 69 (2), 273-281.
- Ettinger, S.N., 2003. Principles of treatment for feline lymphoma. *Clin. Tech. Small Anim. Pract.* 18 (2), 98-102.
- Fan, T.M., Lorimier, L.P.d., 2005. Treating lymphoma in dogs and cats. *Vet. Med.* 100 (4), 285-294.
- Ferreri, A.J., Guidoboni, M., Ponzoni, M., De Conciliis, C., Dell'Oro, S., Fleischhauer, K., Caggiari, L., Lettini, A.A., Dal Cin, E., Ieri, R., Freschi, M., Villa, E., Boiocchi, M., Dolcetti, R., 2004. Evidence for an association between *Chlamydia psittaci* and ocular adnexal lymphomas. *J. Natl. Cancer Inst.* 96 (8), 586-594.
- Fleiss, J.L., 1981. The analysis of data from matched samples. In: *Statistical Methods for Rates and Proportions*. 2nd edition. Wiley Series in Probability and Mathematical Statistics. (John Wiley & Sons, New York), 123-125.
- Foucault, C., Brouqui, P., Raoult, D., 2006. *Bartonella quintana* characteristics and clinical management. *Emerg. Infect. Dis.* 12 (2), 217-223.
- Gavazza, A., Presciuttini, S., Barale, R., Lubas, G., Gugliucci, B., 2001. Association between canine malignant lymphoma, living in industrial areas, and use of chemicals by dog owners. *J. Vet. Intern. Med.* 15 (3), 190-195.
- Gillespie, T.N., Washabau, R.J., Goldschmidt, M.H., Cullen, J.M., Rogala, A.R., Breitschwerdt, E.B., 2003. Detection of *Bartonella henselae* and *Bartonella clarridgeiae*

DNA in hepatic specimens from two dogs with hepatic disease. *J. Am. Vet. Med. Assoc.* 222 (1), 47-51, 35.

Glickman, L., Glickman, N., Thorpe, R., The Golden Retriever Club of America: National Health Survey 1998-1999 <http://www.grca.org/healthsurvey.pdf> [cited 2000 aug 15].

Hansen, K., Khanna, C., 2004. Spontaneous and genetically engineered animal models: Use in preclinical cancer drug development. *Eur. J. Cancer* 40 (6), 858-880.

Hayes, H.M., Tarone, R.E., Cantor, K.P., 1995. On the association between canine malignant lymphoma and opportunity for exposure to 2,4-dichlorophenoxyacetic acid. *Environ. Res.* 70 (2), 119-125.

Henn, J.B., Liu, C.H., Kasten, R.W., VanHorn, B.A., Beckett, L.A., Kass, P.H., Chomel, B.B., 2005. Seroprevalence of antibodies against *Bartonella* species and evaluation of risk factors and clinical signs associated with seropositivity in dogs. *Am. J. Vet. Res.* 66 (4), 688-694.

Kempf, V.A., Hitziger, N., Riess, T., Autenrieth, I.B., 2002. Do plant and human pathogens have a common pathogenicity strategy? *Trends Microbiol.* 10 (6), 269-275.

Kempf, V.A., Schairer, A., Neumann, D., Grassl, G.A., Lauber, K., Lebidziejewski, M., Schaller, M., Kyme, P., Wesselborg, S., Autenrieth, I.B., 2005. *Bartonella henselae* inhibits apoptosis in Mono Mac 6 cells. *Cell. Microbiol.* 7 (1), 91-104.

Kitchell, B.E., Fan, T.M., Kordick, D., Breitschwerdt, E.B., Wollenberg, G., Lichtensteiger, C.A., 2000. Peliosis hepatis in a dog infected with *Bartonella henselae*. *J. Am. Vet. Med. Assoc.* 216 (4), 519-23, 517.

Koehler, J.E., Sanchez, M.A., Garrido, C.S., Whitfeld, M.J., Chen, F.M., Berger, T.G., Rodriguez-Barradas, M.C., LeBoit, P.E., Tappero, J.W., 1997. Molecular epidemiology of *Bartonella* infections in patients with bacillary angiomatosis-peliosis. *N. Engl. J. Med.* 337 (26), 1876-1883.

Kordick, D.L., Breitschwerdt, E.B., 1995. Intraerythrocytic presence of *Bartonella henselae*. *J. Clin. Microbiol.* 33 (6), 1655-1656.

Kosoy, M., Mandel, E., Green, D., Marston, E., Childs, J., 2004. Prospective studies of *Bartonella* of rodents. Part I. demographic and temporal patterns in population dynamics. *Vector Borne Zoonotic Dis.* 4 (4), 285-295.

Kosoy, M.Y., Regnery, R.L., Tzianabos, T., Marston, E.L., Jones, D.C., Green, D., Maupin, G.O., Olson, J.G., Childs, J.E., 1997. Distribution, diversity, and host specificity of *Bartonella* in rodents from the southeastern United States. *Am. J. Trop. Med. Hyg.* 57 (5), 578-588.

Kyme, P.A., Haas, A., Schaller, M., Peschel, A., Iredell, J., Kempf, V.A., 2005. Unusual trafficking pattern of *Bartonella henselae*-containing vacuoles in macrophages and endothelial cells. *Cell. Microbiol.* 7 (7), 1019-1034.

La Scola, B., Raoult, D., 1999. Culture of *Bartonella quintana* and *Bartonella henselae* from human samples: A 5-year experience (1993 to 1998). *J. Clin. Microbiol.* 37 (6), 1899-1905.

Lax, A.J., Thomas, W., 2002. How bacteria could cause cancer: One step at a time. *Trends Microbiol.* 10 (6), 293-299.

Lecuit, M., Abachin, E., Martin, A., Poyart, C., Pochart, P., Suarez, F., Bengoufa, D., Feuillard, J., Lavergne, A., Gordon, J.I., Berche, P., Guillevin, L., Lortholary, O., 2004. Immunoproliferative small intestinal disease associated with *Campylobacter jejuni*. *N. Engl. J. Med.* 350 (3), 239-248.

Liston, T.E., Koehler, J.E., 1996. Granulomatous hepatitis and necrotizing splenitis due to *Bartonella henselae* in a patient with cancer: Case report and review of hepatosplenic manifestations of *Bartonella* infection. *Clin. Infect. Dis.* 22 (6), 951-957.

Lurie, D.M., Lucroy, M.D., Griffey, S.M., Simonson, E., Madewell, B.R., 2004. T-cell-derived malignant lymphoma in the boxer breed. *Vet. Comp. Onc.* 2 (3), 171-175.

Maggi, R.G., Duncan, A.W., Breitschwerdt, E.B., 2005a. Novel chemically modified liquid medium that will support the growth of seven *Bartonella* species. *J. Clin. Microbiol.* 43 (6), 2651-2655.

Maggi, R.G., Harms, C.A., Hohn, A.A., Pabst, D.A., McLellan, W.A., Walton, W.J., Rotstein, D.S., Breitschwerdt, E.B., 2005b. *Bartonella henselae* in porpoise blood. *Emerg. Infect. Dis.* 11 (12), 1894-1898.

Maurin, M., Birtles, R., Raoult, D., 1997. Current knowledge of *Bartonella* species. *Eur. J. Clin. Microbiol. Infect. Dis.* 16 (7), 487-506.

Modiano, J.F., Breen, M., Burnett, R.C., Parker, H.G., Inusah, S., Thomas, R., Avery, P.R., Lindblad-Toh, K., Ostrander, E.A., Cutter, G.C., Avery, A.C., 2005. Distinct B-cell and T-cell lymphoproliferative disease prevalence among dog breeds indicates heritable risk. *Cancer Res.* 65 (13), 5654-5661.

Modiano, J.F., Breen, M., Valli, V.E., Wojcieszyn, J.W., Cutter, G.R., 2007. Predictive value of p16 or Rb inactivation in a model of naturally occurring canine non-Hodgkin's lymphoma. *Leukemia* 21 (1), 184-187.

- Moore, A.S., Cotter, S.M., Rand, W.M., Wood, C.A., Williams, L.E., London, C.A., Frimberger, A.E., L'Heureux, D.A., 2001. Evaluation of a discontinuous treatment protocol (VELCAP-S) for canine lymphoma. *J. Vet. Intern. Med.* 15 (4), 348.
- Morales, S.C., Breitschwerdt, E.B., Washabau, R.J., Matise, I., Maggi, R.G., Duncan, A.W., 2007. Detection of *Bartonella henselae* DNA in two dogs with pyogranulomatous lymphadenitis. *J. Am. Vet. Med. Assoc.* 230 (5), 681-685.
- Pappalardo, B.L., Brown, T., Gookin, J.L., Morrill, C.L., Breitschwerdt, E.B., 2000. Granulomatous disease associated with *Bartonella* infection in 2 dogs. *J. Vet. Intern. Med.* 14 (1), 37-42.
- Pappalardo, B.L., Correa, M.T., York, C.C., Peat, C.Y., Breitschwerdt, E.B., 1997. Epidemiologic evaluation of the risk factors associated with exposure and seroreactivity to *Bartonella vinsonii* in dogs. *Am. J. Vet. Res.* 58 (5), 467-471.
- Parsonnet, J., Friedman, G.D., Vandersteen, D.P., Chang, Y., Vogelman, J.H., Orentreich, N., Sibley, R.K., 1991. *Helicobacter pylori* infection and the risk of gastric carcinoma. *N. Engl. J. Med.* 325 (16), 1127-1131.
- Ranen, E., Lavy, E., Aizenberg, I., Perl, S., Harrus, S., 2004. Spirocercosis-associated esophageal sarcomas in dogs. A retrospective study of 17 cases (1997-2003). *Vet. Parasitol.* 119 (2-3), 209-221.
- Reif, J.S., Lower, K.S., Ogilvie, G.K., 1995. Residential exposure to magnetic fields and risk of canine lymphoma. *Am. J. Epidemiol.* 141 (4), 352-359.
- Resto-Ruiz, S.I., Schmiederer, M., Sweger, D., Newton, C., Klein, T.W., Friedman, H., Anderson, B.E., 2002. Induction of a potential paracrine angiogenic loop between human THP-1 macrophages and human microvascular endothelial cells during *Bartonella henselae* infection. *Infect. Immun.* 70 (8), 4564-4570.
- Serraino, D., Piselli, P., Angeletti, C., Scuderi, M., Ippolito, G., Capobianchi, M.R., 2005. Infection with Epstein-Barr virus and cancer: an epidemiological review. *J. Biol. Regul. Homeost. Agents.* 19 (1-2), 63-70.
- Seubert, A., Schulein, R., Dehio, C., 2002. Bacterial persistence within erythrocytes: A unique pathogenic strategy of *Bartonella* spp. *Int. J. Med. Microbiol.* 291 (6-7), 555-560.
- Solano-Gallego, L., Bradley, J., Hegarty, B., Sigmon, B., Breitschwerdt, E., 2004. *Bartonella henselae* IgG antibodies are prevalent in dogs from southeastern USA. *Vet. Res.* 35 (5), 585-595.

Suksawat, J., Hegarty, B.C., Breitschwerdt, E.B., 2000. Seroprevalence of *Ehrlichia canis*, *Ehrlichia equi*, and *Ehrlichia risticii* in sick dogs from North Carolina and Virginia. J. Vet. Intern. Med. 14 (1), 50-55.

Teske, E., 1994. Canine malignant lymphoma: A review and comparison with human non-Hodgkin's lymphoma. Vet. Q. 16 (4), 209-219.

Vail, D.M., MacEwen, E.G., Young, K.M., 2001. Canine lymphoma and lymphoid leukemias. In: Small Animal Clinical Oncology. 3rd edition. (WB Saunders Company, Philadelphia), 558-560.

Vermi, W., Facchetti, F., Riboldi, E., Heine, H., Scutera, S., Stornello, S., Ravarino, D., Cappello, P., Giovarelli, M., Badolato, R., Zucca, M., Gentili, F., Chilosi, M., Doglioni, C., Ponzi, A.N., Sozzani, S., Musso, T., 2006. Role of dendritic cell-derived CXCL13 in the pathogenesis of *Bartonella henselae* B-rich granuloma. Blood 107 (2), 454-462.

Vernau, W., Moore, P.F., 1999. An immunophenotypic study of canine leukemias and preliminary assessment of clonality by polymerase chain reaction. Vet. Immunol. Immunopathol. 69 (2/3/4), 145.

Williams, C.V., Van Steenhouse, J.L., Bradley, J.M., Hancock, S.I., Hegarty, B.C., Breitschwerdt, E.B., 2002. Naturally occurring *Ehrlichia chaffeensis* infection in two prosimian primate species: Ring-tailed lemurs (*Lemur catta*) and ruffed lemurs (*Varecia variegata*). Emerg. Infect. Dis. 8 (12), 1497-1500.

World Health Organization, 2006. 10 facts about cancer. WHO Fact File at <http://www.who.int/topics/cancer/en/>.

Wotherspoon, A.C., Ortiz-Hidalgo, C., Falzon, M.R., Isaacson, P.G., 1991. *Helicobacter pylori*-associated gastritis and primary B-cell gastric lymphoma. Lancet 338 (8776), 1175-1176.

Table 1. *Bartonella* genus- and species-specific sequences for ITS and Pap31 primers.

Primer name	Primer sequence
<i>Bartonella</i> genus ITS forward primer	5' - AGATGATGATCCCAAGCCTTCTGG - 3'
<i>Bartonella</i> genus and species ITS reverse primer	5' - GATAAACCGGAAAACCTTCCC - 3'
<i>B. henselae</i> -specific ITS forward primer	5' - CAAGCCTTCTGGCGATCTAG - 3'
General <i>Bartonella</i> species ITS forward primer (designed to exclude <i>B. henselae</i> amplification)	5' - CAAGCCTTCGGGCGATCTCT - 3'
<i>B. henselae</i> -specific Pap31 forward primer	5' - TGGGCTGACAGAGAAGACG - 3'
<i>Bartonella</i> genus Pap31 reverse primer	5' - CACCACCAGCAACATAAGGC - 3'

Table 2. *Anaplasma* and *Ehrlichia* genus-specific sequences for 16S rRNA primers.

Primer name	Primer sequence
<i>Ehrlichia</i> and <i>Anaplasma</i> genus forward primer	5' - GCAAGCYTAACACATGCAAGTCGA - 3'
<i>Ehrlichia</i> and <i>Anaplasma</i> genus reverse primer	5' - TATAGGTACCGTCATTATCTTCCCTATTG - 3'

Table 3. Data for all 15 PCR-positive Golden Retrievers (5 dogs with lymphoma and 10 healthy controls) enrolled in the study. Blood and lymph node aspirate samples were screened for *Bartonella* bacteria by targeting a fragment of the 16S-23S intergenic transcribed spacer (ITS) region and the Pap31 gene. *Bartonella* species were confirmed by DNA sequencing.

No.	Sex	Age (yr)	City, ST	Sample type	Bart ITS	Bh Pap31	Pap31
Dogs with lymphoma							
1	M-N	8	Fairfield, NJ	Blood	<i>B. henselae</i> , <i>B. vinsonii</i> (<i>berkhoffii</i>)	<i>B. henselae</i>	<i>B. henselae</i>
				LNA	<i>B. henselae</i>	<i>B. henselae</i>	<i>B. henselae</i>
2	M-I	4	Dallas, TX	Blood	<i>B. henselae</i>	<i>B. henselae</i>	<i>B. henselae</i>
				LNA	<i>B. henselae</i> , <i>B. elizabethae</i>	<i>B. henselae</i>	<i>B. henselae</i>
3	M-N	9	Raleigh, NC	Blood	Negative	Negative	Negative
				LNA	Negative	<i>B. henselae</i>	<i>B. henselae</i>
4	F-S	9	Chatham, VA	Blood	Negative	Negative	Negative
				LNA	<i>B. henselae</i>	Negative	Negative
5	F-S	8	Raleigh, NC	Blood	Negative	Negative	Negative
				LNA	<i>B. quintana</i>	Negative	Negative

Table 3 (continued).

No.	Sex	Age (yr)	City, ST	Sample type	Bart ITS	Bh Pap31	Pap31
Healthy control dogs							
1	M-N	4.5	Medina, OH	Blood	Negative	Negative	Negative
				LNA	<i>B. quintana</i>	Negative	QNS
2	M-N	6	Akron, OH	Blood	<i>B. henselae</i>	<i>B. henselae</i>	<i>B. henselae</i>
				LNA	Negative	Negative	Negative
3	F-S	3	Castro Valley, CA	Blood	<i>B. henselae</i>	Negative	Negative
				LNA	Negative	Negative	Negative
4	M-N	5	Rochester, NY	Blood	Negative	Negative	Negative
				LNA	<i>B. henselae</i> , <i>B. quintana</i>	<i>B. henselae</i>	QNS
5	F-I	7	Prince George, VA	Blood	Negative	Negative	Negative
				LNA	<i>B. henselae</i>	<i>B. henselae</i>	Negative
6	M-N	2	Richmond, VA	Blood	Negative	Negative	Negative
				LNA	<i>B. quintana</i>	Negative	QNS
7	M-N	10	Waterford, CT	Blood	Negative	Negative	Negative
				LNA	<i>B. henselae</i>	<i>B. henselae</i>	<i>B. henselae</i>

Table 3 (continued).

Study ID No.	Sex	Age (yr)	City, ST	Sample type	Bart ITS	Bh Pap31	Pap31
Healthy control dogs							
8	M-N	10	Lyme, CT	Blood	Negative	Negative	Negative
				LNA	<i>B. henselae</i> , <i>B. quintana</i>	<i>B. henselae</i>	<i>B. henselae</i>
9	F-S	7	Clayton, NC	Blood	Negative	Negative	Negative
				LNA	<i>B. henselae</i>	Negative	Negative
10	M-N	2	Greenwich, CT	Blood	Negative	Negative	Negative
				LNA	<i>B. henselae</i>	<i>B. henselae</i>	Negative

LNA: lymph node aspirate

M: male, F: female, I: intact, N: neutered, S: spayed

QNS: quantity not sufficient for testing

Chapter 6. Summary and conclusions

Within the last 25 years, *Bartonella* species have become important vector-borne organisms that are associated with several emerging infectious diseases in both human and veterinary medicine. *Bartonella* species are one of only a few (e.g., *Rickettsia rickettsii*) bacterial pathogens that are able to invade endothelial cells and are unique in their ability to invade endothelial cells, erythroblasts, CD34+ progenitor cells, and dendritic cells of their hosts (Dehio 2004; Jacomo et al., 2002; Mandle et al., 2005; Rolain et al., 2003; Seubert et al., 2002; Vermi et al., 2006). This intracellular infection provides a potentially complex strategy, which facilitates bacterial persistence, evasion of the host immune response, and contributes to a reduction in antimicrobial efficiency. These adaptive features, a large and diverse animal reservoir, an expanding list of vectors involved in transmission, and their significant zoonotic potential, make *Bartonella* species important modern-day pathogens.

Because *Bartonella* species frequently induce persistent intravascular infections, it has been difficult to directly attribute disease causation to *Bartonella* infection, primarily due to the fastidious nature of the organism. Complexities associated with successful isolation have hampered the development and subsequent evaluation of more sensitive diagnostic techniques and have potentially hindered the understanding of the diversity, adaptation, and epidemiology of *Bartonella* species (La Scola et al., 1999). Despite efforts from several research laboratories, sensitive microbiological methods to enhance the isolation of several clinically important *Bartonella* species from immunocompetent humans and dogs have remained elusive.

Considering these factors, research was initiated to characterize and develop a novel, pre-enrichment medium, based on a formulation that promotes the growth of insect cells in culture. During the initial validation, this media, referred to as *Bartonella*/alpha-*Proteobacteria* Growth Medium (BAPGM), supported the isolation and growth of at least seven individual *Bartonella* species and co-cultures of more than one *Bartonella* species. When evaluating BAPGM for use with clinical samples collected from naturally infected cats, *B. henselae* isolates were obtained in a fraction of the time typically required when using the traditional isolation approach on solid blood or chocolate agar plates. Altogether, the utility of BAPGM as a pre-enrichment, liquid media provided a substantial improvement in the detection and isolation of *Bartonella* species.

Equipped with a more sensitive method to grow and maintain *Bartonella* species, a prospective study was performed to evaluate the methods used to diagnose *Bartonella* infection in dog samples submitted to the Vector Borne Disease Diagnostic Laboratory (VBDDL) at North Carolina State University-College of Veterinary Medicine. Modification and refinement of the original BAPGM formulation and minor alterations of the incubation conditions resulted in a multi-faceted approach combining pre-enrichment, liquid BAPGM culture with PCR amplification to identify single *Bartonella* infections and co-infections with *B. henselae* and *B. vinsonii* (*berkhoffii*) in dog samples submitted to the VBDDL. Additionally and perhaps more importantly for comparative microbiological studies, this improved approach facilitated the successful agar plate isolation of single *Bartonella* species and concurrent agar plate isolation of *B. henselae* and *B. vinsonii* (*berkhoffii*) from dog samples. In the dogs surveyed, results of *Bartonella* serological

analyses did not correlate with the identification of *Bartonella* by PCR and sequencing or with successful isolation of *Bartonella* organisms. Both *B. henselae* and *B. vinsonii* (*berkhoffii*) DNA was detected on multiple occasions in dogs that were not seroreactive to the respective *Bartonella* species test antigen. In contrast, dogs that were seroreactive to either *B. henselae* or *B. vinsonii* (*berkhoffii*) antigens were often PCR negative, despite the use of the pre-enrichment media.

Strikingly similar observations were observed when this multi-faceted methodology was utilized in a self-selected population of human patients. The study was conducted to assess the feasibility of the combinational approach using blood samples collected from immunocompetent human patients with arthropod and occupational animal contact. Single and co-infections with *Bartonella* species were detected by PCR and confirmed by sequencing and were also successfully isolated from these study participants. To our knowledge, this study is the first to demonstrate concurrent infection with two *Bartonella* species or strains in the same individual. Similar to the results in dogs, serological analyses did not correlate with PCR amplification or isolation of *B. vinsonii* (*berkhoffii*) and *B. henselae* in the human study participants.

Therefore, in clinical dog samples submitted to the VBDDL and in a group of immunocompetent human patients, this combined approach, using liquid, BAPGM pre-enrichment to increase bacterial numbers, coupled with molecular-based detection, provided a substantial advantage in microbiological documentation of *Bartonella* infection, when compared to traditional inoculation of blood agar plates. This multi-faceted method facilitated the detection and subsequent isolation of single and co-infections with *B.*

henselae and *B. vinsonii (berkhoffii)* in the blood of naturally infected dogs and in the human patients that volunteered for study inclusion. Research is currently underway to enhance the BAPGM, liquid, pre-enrichment media to improve its utility to obtain stable isolates following subculture to a solid agar media. Overall, the utility of BAPGM and its remarkable improvement in the detection and isolation of *Bartonella* species from naturally infected populations represents a significant contribution to the worldwide research efforts to enhance the growth, molecular detection, and maintenance of these fastidious bacteria.

In the final segment of the research presented, a matched, case-control study was performed to evaluate the serological and molecular prevalence of vector-borne pathogens, specifically *Bartonella*, *Anaplasma*, or *Ehrlichia* species, in samples collected from Golden Retrievers with lymphoma and their geographically and breed-matched, healthy controls. No differences were observed in the molecular prevalence of *Bartonella* infections in the blood or lymph nodes of 28 Golden Retrievers with lymphoma (17.9%) when compared to 56 age-, gender-, and geographically matched, healthy Golden Retrievers (17.9%). No differences were noted in the *Bartonella* species detected in dogs with lymphoma versus healthy dogs or between the evidence of infection, as demonstrated by serological analyses, with these vector-borne organisms and lymphoma.

Similar to the results of the previous dog and human studies, serological testing results did not correlate with the presence or absence of *Bartonella* DNA, as detected by PCR and sequencing. Also consistent with the two previous studies, both single *Bartonella* species and co-infections with more than one *Bartonella* were detected in

Golden Retrievers with lymphoma and in clinically healthy, control Golden Retrievers. Regardless of case/control status, *Bartonella* species were detected more frequently in lymph node aspirates than in blood samples. To our knowledge, this is the first report in which *Bartonella* DNA was detected in the lymph nodes of clinically healthy dogs or in dogs with lymphoma. Consistent with earlier reports, a significantly higher proportion of healthy Golden Retrievers were receiving monthly acaricide treatments (2.6 times higher), when compared to dogs with lymphoma. In addition, Golden Retrievers that were PCR positive for *Bartonella* species had prior tick exposure (odds ratio = 3.4) and were classified by their owners as indoor/outdoor dogs (odds ratio = 3.1), when compared to dogs that were PCR negative for *Bartonella* species. Lastly, although several dogs were seroreactive to *A. phagocytophilum*, no *Anaplasma* or *Ehrlichia* DNA was detected by PCR.

Several similarities are observed throughout the work presented within this dissertation. When evaluated using equivalent methodologies, similar *Bartonella* species, particularly *B. henselae* and *B. vinsonii* (*berkhoffii*), were detected by PCR and successfully isolated from dogs with a suspected tick-borne illness and from humans with occupational animal contact and arthropod exposure. *Bartonella henselae* and *B. vinsonii* (*berkhoffii*) are the two most commonly detected species in dogs. Based on the relative insensitivity of conventional methods used to diagnose *Bartonella* infection in animals and humans, it is likely that concurrent infection with more than one *Bartonella* species is critically underestimated. As diagnostic microbiological and molecular methods evolve

and improve, future research should be conducted to elucidate the prevalence and clinical importance of co-infection with more than one *Bartonella* species.

In dogs with suspected tick-borne illness, in humans with animal contact and arthropod exposure, and in the Golden Retriever dogs participating in the case-control study, serological analyses for *B. henselae* and *B. vinsonii* (*berkhoffii*) did not correlate with molecular detection by PCR followed by DNA sequencing or with microbiological isolation. Considering the inconsistencies in the serological data, several potential explanations exist and include: (1) recent infection with inadequate time to develop an IgG antibody response, (2) low antibody concentrations attributable to previous antimicrobial treatment, (3) efficient evasion or lack of immune recognition of *Bartonella* species resulting in a state of immunogenic anergy, (4) sequestration of *Bartonella* species antigen in intracellular compartments, (5) inappropriate *Bartonella* strain used as antigen in serological analyses, and/or (6) lack of sensitivity of the serological assay. This lack of correlation between serology and PCR and/or blood-culture positive patients has been demonstrated in humans infected with *B. quintana* (Brouqui et al., 1999; Drancourt et al., 1996; La Scola et al., 1999) and in rodents infected with *Bartonella* species (Kosoy et al., 1997; Kosoy et al., 2004). Although serology, PCR, and culture are measuring different endpoints (i.e., serology evaluates exposure to *Bartonella* through quantification of an antibody response, PCR tests for detectable *Bartonella* DNA, and culture assesses the viability of *Bartonella* species), the large discrepancy between the serological identification of *Bartonella* antibodies and the molecular detection of DNA or bacterial isolation certainly deserves future study.

Based on the results of the case-control study, current research endeavors include the determination of the precise location of *Bartonella* within lymph nodes using immunohistochemistry, *in situ* hybridization, flow cytometry, and confocal microscopy. Based on these data, longitudinal studies should be conducted to determine whether *Bartonella* species can be transmitted by ticks, whether lymphatic infection is persistent, or whether these bacteria may contribute to the development of lymphoma.

In conclusion, *Bartonella* species cause chronic infection, often characterized by few and very subtle clinical abnormalities or vague symptoms, in companion animals and human patients. The evolution of this genus to evade the host immune response and to efficiently adapt to mammalian reservoir hosts likely results in a lack of detectable antibodies in many infected individuals. To ensure widespread environmental distribution, *Bartonella* species are transmitted by a wide range of arthropod vectors or can be transmitted through the scratch or bite of an infected animal. The features of evolutionary adaptation, transmission by a diverse array of vectors, and the remarkable zoonotic potential of this genus, rank *Bartonella* species among the newest and most significant emerging pathogens in human and veterinary medicine.

Brouqui, P., Lascola, B., Roux, V., Raoult, D., 1999. Chronic *Bartonella quintana* bacteremia in homeless patients. N. Engl. J. Med. 340 (3), 184-189.

Dehio, C., 2004. Molecular and cellular basis of *Bartonella* pathogenesis. Annu. Rev. Microbiol. 58 365-390.

Drancourt, M., Moal, V., Brunet, P., Dussol, B., Berland, Y., Raoult, D., 1996. *Bartonella (Rochalimaea) quintana* infection in a seronegative hemodialyzed patient. J. Clin. Microbiol. 34 (5), 1158-1160.

Jacomo, V., Kelly, P.J., Raoult, D., 2002. Natural history of *Bartonella* infections (an exception to Koch's postulate). Clin. Diagn. Lab. Immunol. 9 (1), 8-18.

Kosoy, M., Mandel, E., Green, D., Marston, E., Childs, J., 2004. Prospective studies of *Bartonella* of rodents. Part I. Demographic and temporal patterns in population dynamics. Vector Borne Zoonotic Dis. 4 (4), 285-295.

Kosoy, M.Y., Regnery, R.L., Tzianabos, T., Marston, E.L., Jones, D.C., Green, D., Maupin, G.O., Olson, J.G., Childs, J.E., 1997. Distribution, diversity, and host specificity of *Bartonella* in rodents from the southeastern United States. Am. J. Trop. Med. Hyg. 57 (5), 578-588.

La Scola, B., Raoult, D., 1999. Culture of *Bartonella quintana* and *Bartonella henselae* from human samples: A 5-year experience (1993 to 1998). J. Clin. Microbiol. 37 (6), 1899-1905.

Mandle, T., Einsele, H., Schaller, M., Neumann, D., Vogel, W., Autenrieth, I.B., Kempf, V.A., 2005. Infection of human CD34+ progenitor cells with *Bartonella henselae* results in intraerythrocytic presence of *B. henselae*. Blood 106 (4), 1215-1222.

Rolain, J.M., Foucault, C., Brouqui, P., Raoult, D., 2003. Erythroblast cells as a target for *Bartonella quintana* in homeless people. Ann. N. Y. Acad. Sci. 990 485-487.

Seubert, A., Schulein, R., Dehio, C., 2002. Bacterial persistence within erythrocytes: A unique pathogenic strategy of *Bartonella* spp. Int. J. Med. Microbiol. 291 (6-7), 555-560.

Vermi, W., Facchetti, F., Riboldi, E., Heine, H., Scutera, S., Stornello, S., Ravarino, D., Cappello, P., Giovarelli, M., Badolato, R., Zucca, M., Gentili, F., Chilosi, M., Doglioni, C., Ponzi, A.N., Sozzani, S., Musso, T., 2006. Role of dendritic cell-derived CXCL13 in the pathogenesis of *Bartonella henselae* B-rich granuloma. Blood 107 (2), 454-462.