

## ABSTRACT

SCHWERI, KATHRYN KELLER. Plant Resistance to Root-Knot Nematodes through RNA Interference Targeting a Parasitism Gene. (Under the direction of Eric Davis).

Root-knot nematodes (RKN), members of the genus *Meloidogyne*, are sedentary plant-parasitic nematodes that infect multiple crop species and cause staggering economic losses worldwide. Proteins produced in specialized esophageal gland cells are secreted from the stylet of RKN to transform recipient host plant root cells into multinucleate giant-cells that are essential for nematode feeding. The peptide encoded by the *Meloidogyne incognita* 16D10 parasitism gene has previously been shown to be involved in giant-cell formation, and host-derived RNA interference (RNAi) against the 16D10 transcript in *Arabidopsis thaliana* resulted in resistance to the four major species of RKN (Huang et al., 2006b). The first objective of this dissertation was to transform two host crop species, tobacco and strawberry, with 16D10RNAi constructs and to test for resistance of the resulting transgenic plants to RKN species. Haploid plants of the *Nicotiana tabacum* cultivars TN90 (burley) and Hicks (flue-cured) were transformed with the 16D10RNAi constructs used by Huang et al. (2006b), and doubled haploid plants were produced. Expression of siRNA by the transgenic tobacco was confirmed by RT-PCR and high-throughput siRNA Ion Proton sequencing. Several lines of the 16D10RNAi transgenic tobacco were found to be significantly more resistant to root-knot nematodes than wild-type untransformed controls. A maximum of 62% reduction in *Meloidogyne arenaria* egg production and a maximum of 52% reduction in *M. incognita* egg production were observed in TN90 16D10RNAi tobacco roots, and a maximum of 73% reduction in egg production of *M. arenaria* was observed in roots of Hicks 16D10RNAi tobacco plants.

Transformation of strawberry with the 16D10-RNAi constructs was also attempted, however explant browning in tissue culture prevented the production of regenerated transgenic strawberry plants. The research described here addresses some of the challenges in strawberry plant tissue culture, and suggests methods for overcoming these issues.

The second objective of this research was to design and create new 16D10 siRNA expression vectors in an attempt to improve siRNA expression. Currently, all work with 16D10RNAi has been performed using the pHANNIBAL vector (Wesley et al., 2001), which utilizes the *CaMV 35S* promoter and the PDK intron as a spacer. The 16D10RNAi-expressing tobacco using the pHANNIBAL vector was found to be less resistant to root-knot nematodes than the 16D10RNAi Arabidopsis created by Huang et al. (2006b). The purpose of this research was to determine if altering the 16D10RNAi expression constructs could produce greater siRNA expression and potentially greater resistance to root-knot nematodes. The *35S* promoter was exchanged for two new promoters, *Gmubi* and *Ntcel7*, and the GUS spacer was also substituted for the PDK intron to improve hairpin double-stranded RNA intron splicing. *Gmubi* is a constitutive promoter like *35S*, but has been shown to result in greater expression than *35S* in soybean (Chiera et al. 2007). The *Ntcel7* promoter is a tissue-specific promoter that is only expressed in shoot and root meristematic tissue and weakly expressed in the vasculature, but has been shown to be up-regulated in giant-cells (Wang et al., 2007). All vectors were successfully assembled and electroporated into *Agrobacterium tumefaciens* for plant transformations. To test the efficacy of the new constructs, they were all transformed into *Arabidopsis thaliana* using the floral dip method. Self-pollination and selection of Arabidopsis to obtain homozygous lines is currently underway and the resulting lines will be tested for siRNA expression and root-knot nematode resistance.

© Copyright 2013 Kathryn Keller Schweri

All Rights Reserved

Plant Resistance to Root-Knot Nematodes through RNA Interference  
Targeting a Parasitism Gene

by  
Kathryn Keller Schweri

A dissertation submitted to the Graduate Faculty of  
North Carolina State University  
in partial fulfillment of the  
requirements for the degree of  
Doctor of Philosophy

Plant Pathology

Raleigh, North Carolina

2014

APPROVED BY:

---

Eric Davis  
Committee Chair

---

George Allen

---

Ramsey Lewis

---

Stephen Koenning

---

Todd Wehner

## **BIOGRAPHY**

Kathryn Schweri was born on August 11, 1985, in Lexington, Kentucky. She completed her Bachelor of Science degree in Agricultural Biotechnology from the University of Kentucky in 2007, under the advisement of Dr. Christopher Schardl. While there she completed a summer research internship at Alltech Biotechnology in Nicholasville, KY, working with mannoprotein extraction from yeast. She was awarded a Beckman scholarship for her research in the lab of Dr. Christopher Schardl, researching ergot alkaloids produced by fungal endophytes of various grass species. In Aug 2007, Kathryn accepted a graduate research program at North Carolina State University in the Department of Plant Pathology to pursue her PhD. She completed a summer research internship at Bayer CropScience in Morrisville, NC, researching the mode of action of various nematode-active proteins and optimization of nematode culture and bioassays for toxin activity. Kathryn conducted her PhD research on developing transgenic root-knot nematode resistance in plants using RNA interference under the direction of Dr. Eric L. Davis.

## ACKNOWLEDGMENTS

I would first like to thank my major advisor, Dr. Eric L. Davis, for his support and guidance during the pursuit of my graduate degree. He was always available when I needed help, even when he had more demands on his time after he became interim department head. I would also like to thank all of the members of my committee who have helped me throughout my degree. In particular I would like to thank Dr. Ramsey Lewis for providing me with tobacco tissue when I needed it, sometimes on rather short notice, and Dr. George Allen, for his help with strawberry transformation and vector design. I thank my sources of funding, BARD, the North Carolina Tobacco Foundation, USDA CSREES, PPSNC, and Lorillard Tobacco.

I would also like to thank all the people in the Davis Lab who helped me over my graduate career, in particular our technician, Chunying Li, who was instrumental in my graduate work. I thank Dr. Adreinne Smith, my friend and co-graduate of the Davis Lab. I also thank the Davis lab post-docs who have helped me, Bingye Xue, Nouredine Hamamouch, Joe Chiera, and Megan Leach, and all the undergraduates who helped, especially Harper Niver, Billie Espejo, Julia Heiken, Leah Elsea Vang, and Alyssa Koehler.

I'd also like to thank the members of the GSL, Micropropagation Unit, Dr. Elizabeth Scholl, and Dr. Sergei Krasnyanski, who also helped with my project. I would also be remiss if I didn't thank my family and friends for all their support during my life. My mom and dad, grandparents, aunts, uncles, and cousins have always been supportive. In particular I'd like to thank my friends, Vibh Forsythe, Anne Vanderhorst, Allison Horner, Lauren Elliott, Kestrel McCorkle, and Kathleen Burchardt for mental and emotional support.

## TABLE OF CONTENTS

|   |     |
|---|-----|
| LIST OF TABLES .....                                      | vi  |
| LIST OF FIGURES .....                                     | vii |
| LITERATURE REVIEW .....                                   | 1   |
| General Introduction .....                                | 1   |
| Life Cycle of <i>Meloidogyne</i> species .....            | 2   |
| Nematode Secreted Effectors .....                         | 4   |
| The Root-Knot Nematode <i>16D10</i> Parasitism Gene ..... | 6   |
| Management Strategies for <i>Meloidogyne</i> spp. ....    | 7   |
| Plant Transformation and Genetic Engineering .....        | 10  |
| RNA Interference (RNAi) .....                             | 14  |
| References .....  | 22  |

|   |    |
|---|----|
| TRANSFORMATION OF TOBACCO FOR siRNA DERIVED RESISTANCE TO<br>ROOT-KNOT NEMATODE .....       | 48 |
| Abstract .....  | 48 |
| Introduction .....  | 49 |
| Materials and Methods .....   | 53 |
| <u>RNAi Vectors and Tobacco Transformation</u> .....  | 53 |
| <u>Production of Doubled Haploid Lines</u> .....  | 54 |
| <u>PCR of Tobacco Genomic DNA and RT-PCR of the PDK Intron</u> .....                        | 54 |
| <u>Nematode Culture</u> .....   | 55 |
| <u><i>M. arenaria</i> Infection Assays</u> .....  | 56 |
| <u>Infection Assays with Other <i>Meloidogyne</i> species</u> .....                         | 57 |
| <u>siRNA Expression Analysis</u> .....  | 58 |
| Results .....   | 59 |
| <u>Tobacco Transformation and Tobacco Doubled Haploid Production</u> .....                  | 60 |
| <u>PCR of Tobacco Genomic DNA and RT-PCR of the PDK Intron</u> .....                        | 60 |
| <u><i>M. arenaria</i> Multi-line Nematode Infection Assays</u> .....                        | 61 |
| <u>siRNA Sequencing</u> .....   | 64 |
| <u>TN90 I-8 Nematode Infection Assays with Multiple <i>Meloidogyne</i> species</u><br>..... | 66 |
| Discussion .....  | 69 |
| References .....  | 77 |

|   |     |
|---|-----|
| MODIFICATIONS OF 16D10RNAi CONSTRUCTS FOR POTENTIAL IMPROVED<br>EXPRESSION IN <i>ARABIDOPSIS THALIANA</i> ..... | 99  |
| Abstract .....  | 99  |
| Introduction .....  | 100 |
| Materials and Methods .....   | 104 |
| <u>Vector Cloning</u> .....   | 104 |
| <u><i>Arabidopsis thaliana</i> Transformation and DNA Extraction</u> .....                                      | 107 |

|  |     |
|--|-----|
| <u>PCR Confirmation of the Presence of the Insert</u> .....      | 108 |
| <b>Results</b> .....   | 108 |
| <b>Discussion</b> .....  | 110 |
| <b>References</b> .....  | 111 |
| <br>   |     |
| <b>STRAWBERRY TRANSFORMATION WITH 16D10RNAi CONSTRUCTS</b> ..... | 125 |
| <b>Abstract</b> .....  | 125 |
| <b>Introduction</b> .....  | 126 |
| <b>Materials and Methods</b> .....                               | 129 |
| <u>Tissue Source and Tissue Sterilization</u> .....              | 129 |
| <u>RNAi Vectors</u> .....  | 129 |
| <u>Preparation of Agrobacteria</u> .....                         | 130 |
| <u>Strawberry Transformation Method 1</u> .....                  | 130 |
| <u>Strawberry Transformation Method 2</u> .....                  | 131 |
| <u>Strawberry Transformation Method 3</u> .....                  | 131 |
| <u>Strawberry Transformation Method 4</u> .....                  | 131 |
| <u>Strawberry Transformation Method 5</u> .....                  | 131 |
| <b>Results</b> .....   | 132 |
| <b>Discussion</b> .....  | 133 |
| <b>References</b> .....  | 138 |



## LIST OF TABLES

### TRANSFORMATION OF TOBACCO FOR siRNA DERIVED RESISTANCE TO ROOT-KNOT NEMATODE

|  |    |
|--|----|
| Table 1. <i>M. arenaria</i> infection assays testing multiple transformed 16D10RNAi lines .....                          | 82 |
| Table 2. <i>M. arenaria</i> TN90 16D10RNAi-I infection assay repeat for siRNA sequencing.....                            | 83 |
| Table 3. Expression of siRNA in roots of TN90 16D10RNAi-I tobacco lines prior to infection with <i>M. arenaria</i> ..... | 84 |
| Table 4. TN90 I-8 infection assays with multiple <i>Meloidogyne spp</i> .....  | 85 |

### MODIFICATIONS OF 16D10RNAi CONSTRUCTS FOR POTENTIAL IMPROVED EXPRESSION IN *ARABIDOPSIS THALIANA*

|   |     |
|---|-----|
| Table 5. <i>Arabidopsis thaliana</i> lines produced ..... | 115 |
|---|-----|

## LIST OF FIGURES

### LITERATURE REVIEW

|   |    |
|---|----|
| Figure 1. Life cycle of the root-knot nematode .....  | 42 |
| Figure 2. Esophageal gland cells of plant parasitic nematodes .....   | 43 |
| Figure 3. A model for the mechanism of exogenous RNA interference (RNAi) in a nematode cell .....   | 44 |
| Figure 4. Model for expression of host-derived RNA interference against <i>Meloidogyne spp.</i> and predicted siRNA ingestion by the nematode ..... | 45 |
| Figure 5. Structure of the RNA produced by the 16D10-RNAi constructs ...  | 46 |
| Figure 6. Design of the transgene used for RNAi against the 16D10 gene, as designed by Huang et al. (2006, PNAS) .....                              | 47 |

### TRANSFORMATION OF TOBACCO FOR siRNA DERIVED RESISTANCE TO ROOT-KNOT NEMATODE

|   |    |
|---|----|
| Figure 7. Design of the transgene used for RNAi against the 16D10 gene, as designed by Huang et al. (2006, PNAS) .....              | 86 |
| Figure 8. PCR design and primers used to identify the 16D10RNAi constructs .....  | 87 |
| Figure 9. PCR amplification of the 16D10RNAi construct from TN90 genomic DNA .....  | 88 |
| Figure 10. PCR amplification of the 16D10RNAi construct from Hicks genomic DNA .....  | 89 |
| Figure 11. Expression of the 16D10RNAi construct as measured by RT-PCR of the PDK intron using TN90 tobacco cDNA as template .....  | 89 |
| Figure 12. Expression of the 16D10RNAi construct as measured by RT-PCR of the PDK intron using Hicks tobacco cDNA as template ..... | 90 |
| Figure 13. <i>M. arenaria</i> infection assay of TN90 16D10-I lines .....   | 91 |
| Figure 14. <i>M. arenaria</i> infection assay of Hicks 16D10-I lines .....  | 92 |
| Figure 15. <i>M. arenaria</i> infection assay of Hicks 16D10-II lines .....   | 93 |
| Figure 16. <i>M. arenaria</i> infection assay repeat of TN90 16D10-I lines used for siRNA sequencing .....                          | 94 |
| Figure 17. TN90 I-8 <i>M. arenaria</i> infection assay results .....  | 95 |
| Figure 18. TN90 I-8 <i>M. incognita</i> infection assay results .....   | 96 |
| Figure 19. TN90 I-8 <i>M. javanica</i> infection assay results .....  | 97 |
| Figure 20. Normalized data from the TN90 I-8 infection assays with multiple <i>Meloidogyne spp.</i> .....                           | 98 |

### MODIFICATIONS OF 16D10RNAi CONSTRUCTS FOR POTENTIAL IMPROVED EXPRESSION IN *ARABIDOPSIS THALIANA*

|   |     |
|---|-----|
| Figure 21. Design of the transgene used for RNAi against the 16D10 gene, as designed by Huang et al. (2006, PNAS) ..... | 116 |
| Figure 22. Design for creation of the new RNAi vectors .....  | 117 |
| Figure 23. PCR design and primers used to confirm the presence of the construct .....                                   | 118 |
| Figure 24. PCR amplification of the 35S:16D10-1:PDK construct .....   | 119 |
| Figure 25. PCR amplification of the 35S:GFPRNAi:PDK construct.....  | 120 |
| Figure 26. PCR amplification of the 35S:16D10-1:GUS construct .....   | 121 |
| Figure 27. PCR amplification of the 35S:16D10-2:GUS construct .....   | 121 |
| Figure 28. PCR amplification of the 35S:GFPRNAi:GUS construct.....  | 122 |
| Figure 29. PCR amplification of the Ntcl7:16D10-1:PDK construct .....   | 122 |
| Figure 30. PCR amplification of the Gmubi:16D10-1:PDK construct .....   | 123 |
| Figure 31. PCR amplification of the Gmubi:16D10-2:PDK construct .....   | 123 |
| Figure 32. PCR amplification of the Gmubi:GFPRNAi:PDK construct.....  | 124 |

### **STRAWBERRY TRANSFORMATION WITH 16D10RNAi CONSTRUCTS**

|  |     |
|--|-----|
| Figure 33. Production of phenols by strawberry tissue in basal MS medium ... ..                                      | 141 |
| Figure 34. Growth of strawberry tissue after the addition of charcoal to the regeneration and selection medium ..... | 142 |

## LITERATURE REVIEW

### General Introduction

Nematodes are aquatic roundworms that are members of the phylum Nematoda, and are the most numerous Metazoa on earth (Decraemer and Hunt, 2006). Most are free-living, feeding on bacteria, fungi, and other nematodes, but some are animal or plant parasites. These parasitic nematodes can cause a great deal of harm to people, pets, livestock, and crops. The annual damage in crop losses due to infection by plant parasitic nematodes was estimated at \$70 billion US dollars worldwide by Sasser and Freckman in 1987, and adjusted for inflation it would be around \$125 billion today (Chitwood, 2003).

The genus *Meloidogyne*, or root-knot nematodes, arguably causes the most crop damage on a world-wide basis (Chitwood, 2003). The species in this genus often have a broad host range, and can parasitize an estimated 2,000 plant species (Sasser, 1980). For example the impact in North Carolina alone in 1994 was estimated at around 1 billion dollars in tobacco losses, around \$40 million in cucurbit losses, and \$55 million in sweet potato losses (Koenning et al., 1999). There are more than 70 described species of root-knot nematodes (Karssen and Moens, 2006) and the four most prevalent and economically important species are *Meloidogyne incognita* (the Southern Root-Knot Nematode), *Meloidogyne arenaria* (the Peanut Root-Knot Nematode), *Meloidogyne hapla* (the Northern Root-Knot Nematode), and *Meloidogyne javanica* (the Javanese Root-Knot Nematode) (Sasser et al., 1983; Taylor et al., 1982). *M. incognita*, *M. arenaria*, and *M. javanica* all produce large galls and are extremely polyphagous, infecting monocots and dicots, while *M.*

*hapla* produces smaller galls and has a slightly smaller host range, infecting mainly dicots in cooler climates (Hunt and Handoo, 2009).

### **Life Cycle of *Meloidogyne* species**

Root-knot nematodes undergo their first molt in the egg, and hatch as second-stage juveniles (J2s) (Figure 1). Second-stage juveniles are the infective stage of the nematode life cycle, and are attracted to roots over a long distance by various soil conditions, including CO<sub>2</sub> (Pline and Dusenbery, 1987) and heat (Dusenbery, 1988; Pline et al., 1988). Once the J2s are in the vicinity of the roots they are attracted to root exudates (Prot, 1980). The J2s penetrate the root near the root tip and migrate intercellularly to the vascular bundle using blunt force from their protrusible stylet (a hollow oral spear) and the release of cell wall degrading enzymes such as endoglucanases (Rosso et al., 1999), pectate lyases (Doyle and Lambert, 2002), and xylanases (Dautova et al., 2001), which degrade cellulose, pectin and hemicellulose, respectively.

Upon reaching the vascular bundle in the root they begin to transform 5-7 xylem parenchyma cells into giant-cells using proteinaceous secretions from their stylets (Wyss et al., 1992; Sundermann and Hussey, 1988; Bird, 1968; Bird and Saurer, 1967). These giant-cells become permanent large, multinucleate feeding cells with increased numbers of cell organelles that arise from karyokinesis without cytokinesis, and function as nutrient sinks to feed the growing nematode (Huang, 1985; Hussey, 1985). Giant cells have increased metabolic rates and increased rates of movement of photosynthates from shoots to roots (McClure, 1977; Bird and Loveys, 1975). Giant-cells develop thickened secondary cell walls

with numerous cell wall ingrowths that are thought to facilitate metabolite transfer into the cells (Jones, 1981). Localized cellular division (hyperplasia) surrounds the giant-cells resulting in the intercalary galls (knots) that can be observed on root-knot nematode-infected roots. Feeding does not occur until the giant-cells are formed, and consists of distinct cycles of metacarpal bulb pumping as secretions are exuded followed by periods of feeding (Sijmons et al., 1994; Wyss et al., 1992). These cycles of feeding and exudation have also been observed in other sedentary plant-parasitic nematodes including the beet-cyst nematode, *Heterodera schachtii* (Wyss, 1992; Wyss and Zunke, 1986). Feeding from the giant-cells is also characterized by the production of a feeding tube in the giant-cells, which is thought to act as a sieve excluding large particles (Hussey and Mims, 1991; Ruppenhorst, 1984). After feeding begins, the J2s molt quickly through J3/J4 stages in the same cuticle without feeding. Non-feeding, non-sexual males are produced minimally in the major RKN species with the majority of adults emerging as enlarged, pyriform females within the gall tissue. During development to adult female the somatic muscles atrophy, causing them to become completely sedentary, making them entirely dependent on the giant-cells for nutrition for the remainder of their life cycle. While the major root-knot nematodes reproduce asexually by parthenogenesis, sexual males are produced in both facultative amphimictic species such as *Meloidogyne hapla* (Goldstein and Triantaphyllou, 1982) and in parthenogenic species, although they are produced more often in parthenogenic species when stresses such as overcrowding or food shortages occur. Each female lays several hundred eggs into a gelatinous mass produced by the female's rectal glands that are usually deposited on the surface of the root gall, although in rare cases they may be embedded in root tissue as well.

The life cycle of the major RKN species is about one month under relatively optimal conditions, allowing multiple generations during a typical crop growing season.

### **Nematode Secreted Effectors**

Plant parasitic nematodes have evolved elaborate secretory cells in the esophagus that connect to the stylet (Figure 2) and change in contents and activity during parasitism (Davis et al., 2008; Hussey 1989). These secretory cells are called esophageal gland cells, and root-knot nematodes have three esophageal gland cells, one dorsal gland and two subventral glands. They have a cytoplasmic extension ending in a storage ampulla, which is connected to the esophageal lumen by an elaborate valve through which the secretory granules can be pumped into the esophagus and out through the stylet (Hussey and Mims, 1990). Evidence suggests that these secretory granules contain effector proteins that root-knot nematodes secrete through the stylet to modify plant cells for feeding (Davis et al., 2004; Hussey et al., 1994; Mitchum et al., 2013; Sijmons et al., 1994). As these effector molecules are essential for parasitism, the genes that encode them are known as parasitism genes (Davis et al., 2000). Endoglucanases and other cell-wall modifying enzymes are expressed by the subventral glands (Rosso et al., 1999), which are most active during migration and the early stages of development (Hussey and Mims, 1990; Bird, 1983). During the parasitic stages, the dorsal gland becomes enlarged and secretory granule production in the dorsal gland increases, while secretory granule production in the subventral glands decreases (Hussey and Mims, 1990; Bird, 1983). This indicates that proteins found to be secreted from the subventral glands are most likely involved in early plant-parasite interactions such as migration in roots and the

early stages of feeding site formation, while proteins secreted by the dorsal gland are more likely to be involved in giant cell formation and maintenance (Davis et al., 2000).

Several methods of identifying the effector proteins in the root-knot nematode secretome have been used (Rosso et al., 2012). Huang et al. (2003) microaspirated the esophageal gland cells of 10 different stages of root-knot nematode and created gland cell cDNA libraries and sequenced 2,452 cDNA clones. Of these clones, only 185 had a signal peptide signaling for secretion as determined by SignalP analysis (Nielsen et al., 1997). The presence of a signal peptide indicates that the protein is secreted from the cell, which in theory would be necessary for it to be exuded by the nematode (Davis et al., 2008). To further screen the library the 185 clones were subjected to high-throughput in situ mRNA hybridization in *M. incognita* (Huang et al., 2003). Of the 185 genes, only 37 were found to specifically hybridize to transcripts accumulating in either the subventral or dorsal glands, making them putative parasitism genes that encode secreted nematode effector proteins. Another method of identifying putative effectors is to mine the genomes of root-knot nematodes. This method has only become available since the sequencing of the *M. incognita* genome (Abad et al., 2008) and sequencing of the *M. hapla* genome (Opperman et al., 2008).

While the functions of many of the potential parasitism genes in *Meloidogyne spp.* are still unknown, the functions of many other important effectors have now been discovered (Mitchum et al., 2013; Haegeman et al., 2012). Cell wall-degrading enzymes that help nematodes invade the root tissue were some of the first RKN effectors to be identified, including endoglucanases (Abad et al., 2008; Bellafiore et al., 2008; Bera-Maillet et al., 2000; Opperman et al., 2008; Roze et al., 2008; Ledger et al., 2006; Rosso et al., 1999),



pectate lyases (Abad et al., 2008; Bellafiore et al., 2008; Opperman et al., 2008; Roze et al., 2008; Huang et al., 2005a; Doyle and Lambert, 2002), xylanases (Abad et al., 2008; Mitreva-Datova et al., 2006), and proteases (Viera et al., 2011). *Meloidogyne spp.* also secrete proteins that may help with protection from plant defenses including glutathione-S-transferases (Dubreuil et al., 2007) and peroxiredoxin (Dubreuil et al., 2011). Some examples of other putative parasitism genes identified are chorismate mutase (Huang et al., 2005b; Lambert et al., 1999), cytokinin (De Meutter et al., 2003), the venom allergen-like protein (Ding et al., 2000), calreticulin (Jaubert et al., 2002), acid phosphatase (Huang et al., 2003), and *16D10* (Huang et al., 2003).

### **The Root-Knot Nematode *16D10* Parasitism Gene**

The *16D10* parasitism gene discovered by Huang et al. (2003) was most highly expressed in the subventral glands of infective J2 of RKN but also had some expression in the subventral glands in later parasitic nematode stages. This gene was of particular interest since the subventral glands are generally less active in later parasitic stages. Also, the *16D10* gene (Huang et al., 2006a; Huang et al., 2003,) encoded a novel and unusually small mature peptide, only 13aa in length, less than half the size of its secretion signal peptide (30 aa) (Wang et al., 2001). Huang (2006a) performed Western dot blots and ELISA of root-knot nematode stylet secretions and showed that the 16D10 protein was secreted from the stylet when secretion was induced by resorcinol. A southern blot of the four major species of root-knot nematode showed that *16D10* is conserved in all four major species, although the blot in *M. hapla* was faint and distinct from the other three species, but was absent from species

tested in two other nematode genera, *Heterodera glycines* and *Caenorhabditis elegans*. To determine whether *16D10* was present in plants, a southern blot with DNA from *Nicotiana tabacum* and *Arabidopsis thaliana* was performed, and the *16D10* gene was not found (Huang et al., 2006a). BLASTp searches confirmed that the predicted 16D10 sequence was unique, but conserved among existing database entries for root-knot nematode species. Although 16D10 had some similarity to CLE signal peptides of plants (Huang et al., 2006; Mitchum et al. 2012), expression of *16D10* in *Arabidopsis* did not produce a CLE phenotype nor complement a *clv-3* mutant (Huang et al., 2006a). Overexpression of the *16D10* gene in *Arabidopsis*, however, did produce transgenic plants with significantly increased root lengths due to increased root cell division (Huang et al., 2006a). A yeast two-hybrid protein interaction assay showed that 16D10 interacts with plant SCARECROW-like transcription factors (Di Laurenzio et al., 1996) specifically the SAW domain of SCL proteins (Huang et al., 2006a). The SCARECROW transcription factor in *Arabidopsis* has been shown to be involved in early cell differentiation (Scheres et al., 1995) and in asymmetric cell division (Di Laurenzio et al., 1996). This interaction with a transcription factor involved in cell differentiation led to the conclusion that the 16D10 effector might potentially regulate transcription in the host cell nucleus that may be involved in giant-cell formation (Huang et al., 2006a).

### **Management Strategies for *Meloidogyne* spp.**

There are many different management tactics for controlling *Meloidogyne* species, although their effectiveness and expense can vary greatly depending on the host crop and the

species of root-knot nematode. Chemical control is used in relatively high-value crops, but human health and environmental concerns have caused many of the most effective nematicides to be banned (Nyczepir and Thomas, 2009). Examples of this include the banning of 1,2-dibromo-3-chloropropane as a soil fumigant by 1981 (Johnson and Feldmesser, 1987) and the phase out of methyl bromide due to its contribution to ozone depletion (Clean Air Act, 1990). Examples of fumigant nematicides that are still in use include 1,3-dichloropropene and metam sodium (Horton et al., 2007). There are also several non-fumigant nematostatic chemicals available, primarily organophosphates and carbamates, which act as acetylcholinesterase inhibitors (Nyczepir and Thomas, 2009; Opperman and Chang, 1990). Unfortunately many nematicides still in use are either expensive, harmful to the environment, or highly toxic to non-target organisms, including humans. This makes development of new non-chemical control methods important for the future of agriculture.

Along with chemical controls, biological and cultural control methods also have potential for nematode control in agriculture. One potential biological control is the endoparasitic bacteria *Pasteuria penetrans*, which parasitizes *Meloidogyne spp.* by producing endospores which penetrate the nematode body wall (Chen et al., 1996; Chen et al., 1997; Sayre and Starr, 1985). Another biological management strategy is the use of nematophagous fungi such as *Paecilomyces lilacinus* and *Pochonia chlamydosporia* (Siddiqui and Mahmood, 1996). Unfortunately biological controls display limited effectiveness and the current costs of culturing sufficient quantities of biological materials can be prohibitive for most uses in the field. Cultural control methods for nematodes such as crop rotation, solarization, sanitation, soil amendments, and trap cropping also have potential,

but the wide host range of root-knot nematodes and long-term survivability of nematode eggs in the soil can limit the effectiveness of these practices for root-knot nematode control.

An important and effective management strategy for plant parasitic nematodes is the development and use of resistant crop cultivars. Sources of resistance are available for many crops including, but not limited to, the *RKN* genes in cotton (Wang et al., 2006), the *Mur1* gene in grape (Cousins et al., 2003), the *Me* genes in pepper (Djian-Caporalino et al. 2007), the *Rk* gene in tobacco (Yi et al., 1998), and the *Mi* genes in tomato (Yaghoobi et al., 1995). However, sources of resistance are not available for all hosts of root-knot nematodes (Williamson and Roberts, 2009). Another problem with host resistance obtained by conventional breeding methods is that many resistance genes are only effective against a few species of *Meloidogyne* or even only a few races of one species (Williamson and Roberts, 2009). For example, the *Rk* gene in tobacco only confers resistance to *M. incognita* races 1 and 3 (Yi et al., 1998). Another problem is that resistance genes are often not durable for long periods of time as virulent populations can evolve to overcome resistance, especially in the case of gene-for-gene resistance (Castagnone-Sereno, 2002). For example, virulent populations of *M. incognita*, *M. arenaria* and *M. javanica* that are able to overcome the resistance conferred by the *Mi* gene in tomato have been found in several areas where tomatoes are commonly grown (Devran and Söğüt, 2010; Tzortzakakis et al., 2005; Eddaoudi et al., 1997; Kaloshian et al., 1996). In order to address these problems, many researchers are investigating ways to use biotechnology to genetically engineer plants to be resistant to nematodes, including the use of RNA interference (Rosso et al., 2009).

## **Plant Transformation and Genetic Engineering**

Plant transformation is a technique whereby foreign DNA is introduced into a plant in order to produce a genetically engineered plant that expresses a desired trait. There are many ways to introduce the foreign DNA, including the use of a gene gun or a viral vector, but one of the most common methods is the use of *Agrobacterium tumefaciens* to transfer and integrate foreign DNA into the genome of plant cells during the bacterium's infection process (Akhond and Machray, 2009). *Agrobacterium tumefaciens* (originally named *Bacterium tumefaciens*) was identified as the causative agent of crown gall disease by Smith and Townsend in 1907, although 10 years earlier crown gall was described as caused by a bacterium by Fridiano Cavara (Cavara, 1897). Crown gall disease is a particular problem for grapes, nut and stone fruit trees, and is characterized by the formation of a large tumor-like gall around the crown of the infected plant (Pacurar et al., 2011). It was first proposed that the bacteria produced a "tumor inducing principle" by Braun in 1947. The tumor inducing principle was first identified as the T-DNA (transferred DNA) region from the *Agrobacterium*'s Ti (tumor inducing) plasmid to the host cell genome by Chilton et al. (1977). In crown gall disease, the T-DNA inserted by the *Agrobacterium* contains tumorigenesis genes, which result in the formation of the characteristic galling of the plant's crown (Pacurar et al., 2011). In addition genes for opine synthesis are also transferred into the host genome on the plasmid, conferring an advantage to the *Agrobacterium* as it can use the opines as a source of nutrition within the infected host plant.

Chilton (1977) recognized the potential to utilize the T-DNA of *Agrobacterium* to transfer genes-of-interest (GOI) into host plants. Her application of this discovery, along with

work by Schell (Koncz and Schell, 1986) and van Montagu (Van Larebeke et al., 1975) ushered in the era of genetically-engineered plants and earned her and van Montagu the World Food Prize in 2013 (Nachay, 2013). Modern binary plasmids, which have origins of replication for both *Escherichia coli* and *A. tumefaciens* and are engineered to remove the tumorigenesis genes, were subsequently developed resulting in greatly improved plant transformation efficiency (Hellens et al., 2000). Binary vectors generally have a selection gene, typically for antibiotic resistance, such as the neomycin phosphotransferase II (*nptII*), which confers resistance to kanamycin (Beck et al., 1982). This selectable marker is generally placed in the T-DNA and allows for relatively easy selection (survival) of both bacteria containing the vector and plant transformants that express any GOI.

Many transformation methods using *A. tumefaciens* exist, including leaf tissue explant transformation and floral dip transformation (Akhond and Machray, 2009; Clough and Bent, 1998). The leaf disk transformation method was first described by Horsch et al. (1985) using *A. tumefaciens* to transform petunia and tomato. Since then, leaf disk transformation has been used to transform many species of plants, including tobacco (An et al., 1986) and strawberry (Nehra et al., 1989, Nehra et al., 1990).

A technique that can be used to speed the generation of homozygous plants in tobacco (*Nicotiana tabacum*) is the production of doubled haploid plants. For this technique, maternal tobacco haploids are generated using the method of Burk et al. (1979) and then the haploid plants are transformed with the gene of interest. After transformation, doubled haploids are spontaneously produced using the midvein tissue culture method of Kasperbauer and Collins (1972), which results in completely homozygous plants (assuming no mutations or

rearrangements occur), which are then also homozygous for the inserted gene. The double-haploid procedure in tobacco removes the usual need for generations of selfing and selection to obtain homozygous transformants.

The floral dip transformation method is relatively new and was first described by Clough and Bent (1998) on the model plant *Arabidopsis thaliana*. In this method newly-opened flowers are dipped in *Agrobacterium tumefaciens* which infects the flowers and transforms the ovules. After pollination the resulting seeds from successful transformations are heterozygous transformants. It has since been employed to transform other plants in the Brassicaceae family, including pakchoi (Qing et al., 2000), radish (Curtis and Nam, 2001), rapeseed (Wang et al., 2003), salt cress (Inan et al., 2004), and Indian mustard (Chhikara et al., 2012).

A promoter that can activate transcription in plants is also required to express a transgene *in planta*. Perhaps the most commonly used promoter for transgenic expression in plants is the CaMV 35S promoter, originally isolated from the Cauliflower Mosaic Virus (CaMV) by Odell et al. in 1985. The CaMV 35S promoter is highly constitutively expressed in virtually all plant species (Benfey and Chua, 1990; Weising et al., 1988). Another promoter used for high expression in plants is the soybean (*Glycine max*) polyubiquitin promoter (*Gmubi*). This constitutive promoter was first isolated by Chiera et al. (2007) from *Glycine max* (L.) Merr. and had an expression level more than five times greater than the 35S promoter when expressed in lima bean (*Phaseolus lunatus* L.) (Chiera et al., 2007). The *Gmubi* promoter also showed high constitutive expression in transgenic soybean (Hernandez-

Garcia et al., 2009), indicating it is a useful promoter for transgenes that need high levels of expression for proper function.

Targeted expression of transgenes can also be achieved through the use of inducible promoters that are only activated under certain conditions, or through the use of tissue-specific promoters that are only active in specific cell types (Potenza et al., 2004; Zuo and Chua, 2000). Chemically-inducible promoters are activated in the presence or absence of the chemical inducer. Examples of chemically-inducible promoters include the GVG transcription factor, which is activated by dexamethasone (dex) (Aoyama and Chua, 1997) and the AlcR transcription factor which is induced by alcohol (Caddick et al., 1998). Gene expression can also be repressed by chemicals, for example the *TetR* repressor is de-repressed by tetracycline (Gatz et al., 1992; Gatz and Quail, 1988). Many promoters are active in certain tissue types (Potenza et al., 2004), and examples include floral-specific promoters such as bean *CHS15* (Faktor et al., 1996), green tissue-specific promoters such as *Arabidopsis thaliana CAB2* (Carre and Kay, 1995), and root-specific promoters such as *Agrobacterium rhizogenes rolD* (Leach and Aoyagi, 1991). Some plant promoters are induced in nematode feeding cells, making them useful for bioengineering plants to provide nematode resistance. Examples of feeding site induced promoters include *TobRB7* (Opperman et al., 1994) and the *Nicotiana tabacum cel7* (*Ntcel7*) promoter (Wang et al., 2007). The *Ntcel7* gene was found to be strongly-expressed in both root-knot and cyst nematode feeding sites (Goellner et al., 2001), whereas the *TobRB7* promoter was active in root-knot but not cyst nematode feeding cells (Opperman et al., 1994). Wang et al. (2007) also demonstrated that the *Ntcel7* promoter was induced by nematode infection in several



distinct plant species and by auxin, which is known to accumulate in nematode feeding sites (Gheysen and Mitchum, 2011). While the *Ntcel7* promoter is also expressed in shoot and root meristematic tissue and weakly expressed in the vasculature, it is still most highly expressed in giant-cells and syncytia induced by cyst nematode, making it a useful promoter for genetically engineering resistance to nematodes (Wang et al., 2007). Careful selection of the GOI driven by the *Ntcel7* promoter can minimize potential off-target effects on the plant host.

While no plants genetically engineered for nematode resistance have been commercialized and approved to date by the FDA, EPA or USDA, there are examples of transgenic plants designed to combat disease currently available in the market (Frizzi et al., 2010). Perhaps the best example is the transgenic Rainbow and SunUp papaya which was genetically engineered to be resistant to the papaya ringspot virus, PRSV (Fitch et al., 1992). These two cultivars of papaya are a huge success story as they saved Hawaii's papaya industry and after 20 years in use have resulted in no safety or ecological issues (Fuchs et al., 2007). The basis for the resistance of these papaya cultivars is expression of the gene encoding the coat protein from PRSV (Fitch et al., 1992).

### **RNA Interference (RNAi)**

The discovery that expression of a viral coat protein in a transgenic plant resulted in resistance to the virus was originally discovered by Abel et al. in 1986, who expressed the tobacco mosaic virus (TMV) coat protein in tobacco. This resistance was termed coat protein-mediated resistance (Lindbo and Dougherty, 2005), and was not linked to RNA

degradation until 1993 (Lindbo et al., 1993). Around the same time Napoli et al. (1990) and van der Krol et al. (1990) discovered that overexpressing a plant gene in the plant resulted in silencing of that gene, and called it co-suppression. English et al. (1996) discovered that co-suppression of non-viral transgenes derived from a potato virus X vector was also linked to RNA degradation that resulted from infection with potato virus X containing sequences homologous to the non-viral transgenes. However the mechanism behind RNA interference was not discovered until 1998, when Fire et al. discovered RNAi in the free-living nematode *Caenorhabditis elegans*.

Since the discovery of the mechanism of RNA-induced gene silencing, or RNA interference (RNAi) (Fire et al., 1998), our understanding of endogenous mechanisms of RNAi in eukaryotes has greatly improved (Feng and Guang, 2013; Shabalina and Koonin, 2008). The mechanism of RNAi is perhaps best understood in *Caenorhabditis elegans*, in which RNAi was first identified (Fire et al., 1998). The pathway for endogenous RNAi in *C. elegans* begins with double stranded-RNA (dsRNA) which is assembled into the dicer complex with the dicer protein DCR-1, the dicer-related helicases DRH-1 and DRH-2 (DRH-3 in the endogenous RNAi pathway), and the Argonaute proteins RDE-1 and RDE-4 (Tabara et al., 1999, 2002, Duchaine et al., 2006) (Figure 3). It is then cleaved into ~22 nt small interfering RNAs (siRNAs) by DCR-1, which again associate with the RDE-1 protein (R09A1.1 in the endogenous pathway), and are integrated into the RISC complex (Yigit et al., 2006). The Argonaute proteins contain two domains, Piwi and PAZ, which interact with the 5' and 3' overhangs of the siRNA and leave the internal nucleotides of the siRNA free to bind the target mRNA (Ma et al., 2005; Parker et al., 2005). The double stranded siRNA is

unwound and associates with the target mRNA of complementary nucleotide sequence, which is then cleaved by the Argonaute protein. This cleavage leads to the degradation of the target mRNA by exonuclease inside P-bodies in the cytoplasm (Meister and Tuschl, 2004; Sheth and Parker, 2003), and thus no translation of that mRNA into a protein, resulting in post-transcriptional gene silencing (PTGS).

In nematodes, plants, and fungi, the RNAi pathway also includes an amplification pathway, in which RNA-Dependent RNA polymerases, EGO-1 in germ-line cells or RRF-1 in somatic cells of *C. elegans*, use the siRNAs bound to the target mRNA as a primer to create more dsRNA (Sijen et al., 2001; Smardon et al., 2000). This dsRNA is then recognized by DCR-1 with the help of the PIR-1 protein (Duchaine et al., 2006), and is cleaved into secondary siRNAs. The secondary siRNAs associate with the secondary Argonautes (SAGO-1, SAGO-2 or PPW-1), again forming the RISC complex and adding to the RNAi-mediated degradation of the target mRNA (Yigit et al., 2006).

The RNAi pathway in plants is similar to the pathway in *C. elegans*, but different proteins are involved (Jamalkandi and Masoudi-Nejad, 2009; Fagard, 2000). HEN1 methylates the 3' terminus of the dsRNA in the nucleus (Li et al., 2005), which then associates with DICER-LIKE 4 (DCL4) (Jamalkandi and Masoudi-Nejad, 2009) (Figure 4). DCL4 cuts the dsRNA into 21nt fragments (Dunoyer et al., 2005), which are then exported from the nucleus. In Arabidopsis the plant exportin 5 Homolog HASTY protein (HST) is involved in miRNA export from the nucleus (Park et al., 2005) but what transports siRNA is unknown (Jamalkandi and Masoudi-Nejad, 2009). Once in the cytoplasm the siRNA are recruited by ARGONAUTE-1 (AGO1), which is the Slicer in the *Arabidopsis* RISC complex

(Baumberger and Baulcombe, 2005; Fagard, 2000), and the target mRNA is cleaved and degraded (Jamalkandi and Masoudi-Nejad, 2009).

The microRNA (miRNA) pathway is similar to the siRNA pathway. In the miRNA pathway, pri-miRNAs are transcribed by RNA polymerase II and are then capped and polyadenylated (Bracht et al., 2004). Next they are processed into ~70 nt pre-miRNAs by the Microprocessor complex, composed of the dsRNA binding protein PASH-1 and the RNase III enzyme Droscha (Denli et al., 2004, Lee et al., 2003). The pre-miRNA is then exported into the cytoplasm, possibly by IMB-4, a homolog of exportin 5 which is the export protein in mammalian cells (Yi et al., 2003, Lund et al., 2004, Parry et al., 2007). Next the pre-miRNA is cleaved into mi-RNA and miRNA by DCR1 and the Argonaute proteins ALG-1 and ALG-2 (Duchaine et al., 2006). The miRNAs can next associate with the miRISC complex and the target mRNA, similar to what occurs in the siRNA pathway, and the target mRNA is cleaved and degraded (Chan et al., 2008; Gu et al., 2007). Unlike siRNAs, miRNAs can also inhibit translation simply by binding to target mRNA and blocking protein synthesis without degrading the mRNA (Wightman et al., 1993).

Exogenous dsRNA can also be used to produce RNAi in *C. elegans*. The pathway for exogenous RNAi begins with the introduction of foreign dsRNA into the nematode, which can be done in several ways, including injection, soaking in dsRNA solution, or feeding of bacteria expressing dsRNA (Fire et al., 1998, Tabara et al., 1998, Timmons et al., 2001). The next step is the uptake of the naked dsRNA into the cells of the nematode, for which the SID-1 protein is required (Winston et al., 2002). Once inside the cell, the RNAi pathway proceeds as in the endogenous pathway, with the incorporation of the exogenous dsRNA into the dicer

complex. In *C. elegans*, RNAi induced by exogenous dsRNA can also spread systemically throughout the nematode. In order for this systemic spread to occur the *sid-1* gene (Winston et al., 2002) and 4 other genes are required, *rsd-2*, *rsd-3*, *rsd-4*, and *rsd-6* (Tijsterman et al., 2004). The *rsd-2*, *rsd-3*, and *rsd-6* genes are required for systemic RNAi in the germline cells, while *rsd-4* and *sid-1* are required for systemic RNAi in somatic tissues of *C. elegans*.

The ability to relatively easily silence a specific target gene using exogenous RNAi provides great utility from potential therapeutic uses in humans to functional genomics applications. RNAi is now fairly commonly used for functional genomics in nematodes where transformation can be difficult, if it is even achievable, so generally stable gene knockouts are not created. Instead researchers look at a gene's function by silencing the transcript using dsRNA targeted to the gene of interest, then observing the resulting phenotype. In *C. elegans*, whole genome wide functional analysis has been performed (Kamath et al., 2003), and this technology is being used more frequently. Another example of genome-wide RNAi functional screening is Zhou et al.'s study in 2008 on the host factors required for HIV infection, in which HeLa P4/R5 cells expressing siRNAs targeted to each gene in the genome were infected with HIV the effect on the disease was observed. In this study they were able to identify 311 host factors involved in HIV infection, 267 of which had not been previously known to be involved.

RNAi can also be used for functional analysis in plants (Small, 2007; McGinnis et al., 2005). It has become widely used for reverse genetics (Fitzgerald et al., 2012), and has been successfully used on many different plants, including cereal species, cotton, potato, sugarcane, and tobacco. One example of the utility of RNAi was the down regulation of

putative water-stress response genes resulting in an increase in water-stress susceptibility in tobacco, demonstrating that the genes were important for drought tolerance (Senthil-Kumar et al., 2010). Another example is the down-regulation of pyrophosphate: fructose 6-phosphate 1-phosphotransferase (PF6P) expression in sugarcane resulting in greater sucrose accumulation (van der Merwe et al., 2010; Groenewald and Botha, 2008).

When designing the RNAi construct to be inserted into the plant, the general design is to have a promoter, followed by sense sequence of the target gene, then an intron spacer, then the antisense of the target gene, ending in a terminator (Wesley et al., 2001). Complementary base pairing of the resulting transcribed sense and antisense mRNA sequences separated by a single-strand intron sequence provides a hairpin RNA shape prior to the subsequent splicing of the intron to produce the mature dsRNA (Figure 4). Smith et al. (2000) showed that hairpin constructs with a functional intron were more effective at yielding strong RNAi in transgenic tobacco than constructs with spacers or non-functional introns. One vector commonly used for RNAi in plants is the pHANNIBAL vector (Wesley et al., 2001) which is driven by the constitutive CaMV 35S promoter and is designed to produce a hairpin RNAi construct using an Arabidopsis *PDK* gene intron as a hairpin spacer.

RNAi has already been used to generate novel traits in plants, and several have already been released commercially. The first commercial release of a crop utilizing RNAi was the Flavr Savr™ tomato (produced by Calgene), which was deregulated in 1992 (Frizzi et al., 2010). During tomato ripening, polygalacturonase degrades the cell wall, and silencing this gene leads to delayed ripening of tomatoes, increasing their shelf-life. When the Flavr Savr™ tomato was released, the mechanism of RNAi had not been discovered yet. The Flavr

Savr™ tomato was designed to post-transcriptionally silence the PG (polygalacturonase) gene by producing an antisense RNA to the PG gene mRNA. A recent study by Krieger et al. (2008) showed that siRNAs against the PG gene are produced in the Flavr Savr™ tomatoes, most likely resulting from the antisense RNA produced by the transgene pairing with the sense mRNA from the target gene, resulting in dsRNA that can induce the RNAi pathway.

Another example of a use for siRNAs includes their use in crops in combating plant diseases. One example of a plant expressing siRNAs targeted against a plant disease that has already been released is the plum line ARS-PLMC5-6 (C5 'HoneySweet' plum) which was produced by the USDA and deregulated in 2007 (Frizzi et al., 2007; Ravelonandro et al., 1997; Scorza et al., 1994). This plum was designed to express the Plum pox virus (PPV) coat protein, but in the process of transcription of the coat protein gene dsRNA matching the coat protein mRNA are produced and the RNAi pathway is initiated, leading to the production and accumulation of 22nt and 25-26nt siRNAs in the transgenic plum's cytoplasm (Hily et al., 2005). This siRNA accumulation leads to resistance to PPV (Ravelonandro et al., 1997, Hily et al., 2005), and when plants in the field were examined no coat protein was found in the transgenic plants due to the high level of silencing (Hily et al., 2004). This resistance was found to be stable, and was shown by Malinowski et al. (2006) to last more than 7 years. An environmental safety test on the C5 transgenic plums was undertaken by Fuchs et al. (2007) and the transgenic plums did not change the diversity or population dynamics of PPV or cause the creation of recombinant lines of PPV over the 8-10 year length of the study.

RNAi can also be used to engineer resistance to plant parasitic nematodes in host crop species. Plant parasitic nematodes are thought to have very similar RNAi pathways to *C. elegans*, and homologs of some of the key proteins necessary for RNAi in *C. elegans* (Figure 3) have already been identified in the root-knot nematode, *Meloidogyne incognita* (Rosso et al., 2009). Studies on RNAi soaking of plant parasitic nematodes, including *Meloidogyne incognita*, (Urwin et al., 2002; Rosso et al., 2009; Huang et al., 2006b) demonstrate specific silencing of target genes providing evidence that dsRNA ingestion by nematodes is can lead to silencing throughout the nematode as in *C. elegans*. These studies also show the potential of using RNAi to alter host-parasite interactions. Plant host-derived resistance to nematodes using RNAi is predicted to work through ingestion of the processed dsRNA (siRNA) by the nematode during feeding (Figures 3 & 4). The ingested siRNAs are then thought to be transported to target cells in the nematode via the the gut of the nematode using homologs of the *sid-1* gene since host-derived RNAi has already been shown to effectively knockdown nematode gene expression in several experiments (Steeves et al., 2006; Yadav et al., 2006; Huang et al., 2006b; Fairbairn et al., 2007; Patel et al., 2008, 2010; Sindhu et al., 2009; Li et al., 2010). An experiment by Yadav et al. (2006) used the expression of hpRNA (hairpin RNA) targeted to two genes in *M. incognita* in transgenic tobacco plants to reduce nematode reproduction. The two target genes, a splicing factor and an integrase, have orthologs shown to have lethal RNAi phenotypes in *C. elegans*, and when a nematode infection assay was performed on the RNAi transgenic tobacco, the transgenic plants were shown to be highly resistant to *M. incognita* as compared to the control plants. Similar plant host-derived RNAi work has been done with cyst nematodes (Hamamouch et



al., 2012; Patel et al., 2010; Steeves et al., 2006; Sindhu et al., 2008). Steeves et al. (2006) showed that transgenic soybeans expressing RNAi complementary to a major sperm protein (*MSP*) gene from *Heterodera glycines* developed fewer cysts and eggs than control plants.

RNAi is also of particular utility in the functional analysis of plant parasitic nematode secreted effectors, since creating gene knockouts via stable transformation is not currently possible in plant parasitic nematodes (Rosso et al., 2009). There are many examples of this use of RNAi including targeting a chitin synthase (Fanelli et al., 2005), neuropeptides (Kimber et al., 2007), and pectate lyase (Bakhetia et al., 2007). Another example of the utility of RNAi for functional analysis was the silencing of the *16D10* gene described previously. To determine whether 16D10 was required for parasitism root-knot nematode J2s were induced to ingest *16D10* dsRNA *in vitro* via soaking in a 16D10 dsRNA solution with resorcinol (Huang et al., 2006b). The *16D10* transcript was shown to be strongly silenced by ingestion of the dsRNA, and after soaking the ability of the J2s to establish a feeding site was impaired as evidenced by 74–81% decrease in reproduction (Huang et al., 2006b).

Huang et al. (2006b) also used a model host plant, *Arabidopsis thaliana*, to deliver host-derived *16D10* dsRNA to root-knot nematodes for ingestion from roots. *Arabidopsis* plants were stably transformed with two different *16D10* dsRNA constructs using *Agrobacterium tumefaciens* and the floral dip method. The 16D10RNAi constructs created in pHANNIBAL (Wesley et al., 2001) by Huang et al. (2006) were driven by the CaMV35S promoter and contained 42bp (16D10RNAi-1) or 271 bp (16D10RNAi-2) of *16D10* sense sequence, followed by the PDK intron, then the corresponding antisense *16D10* sequence followed by the OCS terminator (Figures 5 & 6). The 271 bp RNAi-2 construct represented

the entire 16D10 coding sequence including signal peptide and the 42 bp RNAi-1 sequence match only coding sequence of the mature 16D10 peptide (Figure 6). These constructs were cloned into the pHANNIBAL vector (Wesley et al., 2001) which utilizes a kanamycin resistance gene as a selective marker. Root-knot nematode infection assays of pHANNIBAL::*16D10*RNAi transformed Arabidopsis plants were shown to have significantly less galls (63-90% reduction) and eggs (69-93% reduction) than Arabidopsis transformed with an empty vector (Huang et al., 2006b). Similar strong levels of resistance to the four major species of root-knot nematodes were observed in the 16D10RNAi Arabidopsis plants (Huang et al., 2006b). While the original purpose of Huang et al.'s research was to identify the function of the 16D10 effector, the discovery that 16D10RNAi-expressing Arabidopsis was highly resistant multiple root-knot nematode species led to the conclusion that targeting the *16D10* gene with siRNA in a crop species might produce crops with broad resistance to root-knot nematodes. Using siRNA to target parasitism genes instead of housekeeping genes is of particular interest since many parasitism genes are novel, and therefore siRNAs targeting them are less likely to result in off-target silencing in hosts or biota in the environment.

The hypothesis of this dissertation is that tobacco and strawberry plants transformed with the 16D10RNAi constructs designed by Huang et al. (2006b) will be resistant to multiple root-knot nematode species. Further, this dissertation investigates a second hypothesis that changing the promoter and intron used in the host-derived RNAi construct can improve expression levels of siRNA in transformed plants and result in an increase in nematode resistance compared to the original construct designed by Huang et al. (2006b).

## References

- Abad, P, Gouzy, J, Aury, JM, Castagnone-Sereno, P, Danchin, EGJ, Deleury, E, Perfus-Barbeoch, L, Anthouard, V, Artiguenave, F, Blok, VC, Caillaud, MC, Coutinho, PM, Dasilva, C, De Luca, F, Deau, F, Esquibet, M, Flutre, T, Goldstone, JV, Hamamouch, N, Hewezi, T, Jaillon, O, Jubin, C, Leonetti, P, Magliano, M, Maier, TR, Markov, GV, McVeigh, P, Pesole, G, Poulain, J, Robinson-Rechavi, M, Sallet, E, Ségurens, B, Steinbach, D, Tytgat, T, Ugarte, E, van Ghelder, C, Veronico, P, Baum, TJ, Blaxter, M, Bleve-Zacheo, T, Davis, EL, Ewbank, JJ, Favery, B, Grenier, E, Henrissat, B, Jones, JT, Laudet, V, Maule, AG, Quesneville, H, Rosso, MN, Schiex, T, Smant, G, Weissenbach, J, and Wincker, P. 2008. Genome sequence of the metazoan plant-parasitic nematode *Meloidogyne incognita*. *Nature Biotechnology* 26: 909–915
- Abel, PP, Nelson, RS, De, B, Hoffmann, N, Rogers, SG, Fraley, RT, and Beachy, RN. 1986. Delay of disease development in transgenic plants that express the tobacco mosaic virus coat protein gene. *Science* 232:738–743
- Akhond, M, and Machray, GC. 2009. Biotech crops: technologies, achievements and prospects. *Euphytica* 166:47–59
- Akhtar, S. 2009. Oral delivery of siRNA and antisense oligonucleotides. *J. Drug Target.* 17:491–495
- Agrios, GN. 2005. Plant diseases caused by nematodes. In: Plant Pathology 5<sup>th</sup> edition. : Elsevier Academic Press. Burlington, MA pp826-874
- An, G, Watson, BD, and Cheng, CC. 1986. Transformation of tobacco, tomato, potato, and *Arabidopsis thaliana* using a binary Ti vector system. *Plant Physiol.* 81:301-305
- Aouadi, M, Tesz, GJ, Nicoloso, SM, Wang, M, Chouinard, M, Soto, E, Ostroff, GR, and Czech, MP. 2009. Orally delivered siRNA targeting macrophage Map4k4 suppresses systemic inflammation. *Nature* 458:1180–1184
- Aoyama, T, and Chua, NH. 1997. A glucocorticoid-mediated transcriptional induction system in transgenic plants. *Plant Journal* 11:605-612
- Bakhetia, M, Urwin, PE, and Atkinson, HJ. 2007. qPCR analysis and RNAi define pharyngeal gland cell-expressed genes of *Heterodera glycines* required for initial interactions with the host. *Mol. Plant-Microbe. Interact.* 20:306–312
- Baumberger, N, and Baulcombe, DC. 2005. *Arabidopsis* ARGONAUTE1 is an RNA Slicer that selectively recruits microRNAs and short interfering RNAs. *PNAS* 102:11928–11933
- Beck, E, Ludwig, EA, Reiss, B, and Schaller, H. 1982. Nucleotide sequence and exact localization of the neomycin phosphotransferase gene from Tn5. *Gene* 19:327-336

- Benfey, PN, and Chua, NH. 1990. The cauliflower mosaic virus 35S promoter: combinatorial regulation of transcription in plants. *Science* 250: 959-966
- Bera-Maillet, C, Arthaud, L, Abad, P, and Rosso, MN. 2000. Biochemical characterization of MI-ENG1, a family 5 endoglucanase secreted by the root-knot nematode *Meloidogyne incognita*. *Eur. J. Biochem.* 267:3255–3263
- Bird, AF. 1983. Changes in the dimensions of the esophageal glands in root-knot nematodes during the onset of parasitism. *Int. J. Parasitol.* 13:343–348
- Bird, AF. 1968. Changes associated with parasitism in nematodes. IV. Cytochemical studies on the ampulla of the dorsal esophageal gland of *Meloidogyne javanica* and on exudations from the buccal stylet. *J. Parasitol.* 54:879-890
- Bird, AF, and Loveys, BR. 1975. The incorporation of photosynthates by *Meloidogyne javanica*. *J Nematol* 7:111-113
- Bird, AF, and Saurer, W. 1967. Changes associated with parasitism in nematodes. II. Histochemical and microspectrophotometric analyses of preparasitic and parasitic larvae of *Meloidogyne javanica*. *Journal of Parasitology* 53, 1262-1269
- Bracht, J, Hunter, S, Eachus, R, Weeks, P, and Pasquinelli, AE. 2004. Trans-splicing and polyadenylation of let-7 microRNA primary transcripts. *RNA* 10:1586–1594
- Braun, AC. 1947. Thermal studies on the factors responsible for tumor initiation in crown-gall. *Am J Bot* 3:234-240
- Brown, DJF, Dalmasso, A, and Trudgill, DL. 1993. Nematode pests of soft fruits and vines. In: Evans, K, Trudgill, DL, and Webster, JM. (eds.) *Plant Parasitic Nematodes in Temperate Agriculture* Wallingford (UK), CAB International. pp.431-433
- Burk, LG, Gerstel, DU, and Wernsman, EA. 1979. Maternal haploids of *Nicotiana tabacum* L. from seed. *Science* 206:585-585
- Caddick, MX, Greenland, AJ, Jepson, I, Krause, KP, Qu, N, Riddell, KV, Salter, MG, Schuch, W, Sonnewald, U, and Tomsett, AB. 1998. An ethanol inducible gene switch for plants used to manipulate carbon metabolism. *Nat Biotechnol* 16:177-180
- Carre, IA, and Kay, SA. 1995. Multiple DNA-protein complexes at a circadian-regulated promoter element. *Plant Cell* 7:2039–2051
- Castagnone-Sereno, P. 2002. Genetic variability of nematodes: a threat to the durability of plant resistance genes? *Euphytica* 124:193–199

- Cavara, F. 1897. Tubercolosi della vite. Intorno alla eziologia de alcune malattie di piante coltivate. *Stazioni Sperimentale Agrarie Italiane* 30:483-487
- Chan, SP, Ramaswamy, G, Choi, EY, and Slack, FJ. 2008. Identification of specific let-7 microRNA binding complexes in *Caenorhabditis elegans*. *RNA* 14:2104–2114
- Chen, ZX, Dickson, McSorley, R, Mitchell, DJ, and Hewlett, TE. 1996. Suppression of *Meloidogyne arenaria* race 1 by soil application of endospores of *Pasteuria penetrans*. *J. Nematol.* 28:159-168
- Chen, ZX, Dickson, DW, and Mitchell, DJ. 1997. Suppression mechanisms of *Meloidogyne arenaria* race 1 by *Pasteuria penetrans*. *J. Nematol.* , 29:1–8
- Chhikara, S, Chaudhary, D, Yadav, M, Sainger, M, and Jaiwal, P. 2012. A non-tissue culture approach for developing transgenic *Brassica juncea* L. plants with *Agrobacterium tumefaciens*. *In Vitro Cell Dev Biol Plant* 48:7–14
- Chiera, JM, Bouchard, RA, Dorsey, SL, Park, E, Buenrostro-Nava, MT, Ling, PP, and Finer, JJ. 2007. Isolation of two highly active soybean (*Glycine max* (L.) Merr.) promoters and their characterization using a new automated image collection and analysis system. *Plant Cell Rep* 26:1501-1509
- Chilton, MD, Drummond, MH, Merlo, DJ, Sciaky, D, Montoya, AL, Gordon, MP, and Nester, EW. 1977. Stable incorporation of plasmid DNA into higher plant cells: the molecular basis of crown gall tumorigenesis. *Cell* 11:263-271
- Chitwood, DJ. 2003. Research on plant-parasitic nematode biology conducted by the United States Department of Agriculture-Agricultural Research Service. *Pest Manage. Sci.* 59:748–753
- Clough, SJ, and Bent, AF. 1998. Floral dip: A simplified method for *Agrobacterium*-mediated transformation of *Arabidopsis thaliana*. *Plant J.* 16:735-743
- Curtis, IS, and Nam, HG. 2001. Transgenic radish (*Raphanus sativus* L. *longipinnatus* Bailey) by floral-dip method—plant development and surfactant are important in optimizing transformation efficiency. *Transgenic Res* 10:363–371
- Dautova, M, Rosso, MN, Abad, P, Gommers, FJ, Bakker, J, and Smant, G. 2001. Single pass cDNA sequencing—a powerful tool to analyse gene expression in preparasitic juveniles of the southern root-knot nematode *Meloidogyne incognita*. *Nematology* 3:129–139
- Davidson, BL, and McCray, PB Jr. 2011 Current prospects for RNA interference-based therapies. *Nature Rev. Genet.* 12:329–340

- Davis, EL, Hussey, RS, and Baum, TJ. 2004. Getting to the roots of parasitism by nematodes. *Trends Parasitol.* 20:134-141
- Davis, E, Hussey, R, Baum, T, Bakker, J, Schots, A, Rosso, M, and Abad, P. 2000. Nematode parasitism genes. *Annu Rev Phytopathol* 38:365–396
- Davis, EL, Hussey, RS, Mitchum, MG, and Baum, TJ. 2008. Parasitism proteins in nematode-plant interactions. *Current Opinion in Plant Biology* 11:360–366
- De Meutter, J, Tytgat, T, Witters, E, Gheysen, G, Van Onckelen, H, and Gheysen, G. 2003. Identification of cytokinins produced by the plant parasitic nematodes *Heterodera schachtii* and *Meloidogyne incognita*. *Mol. Plant Pathol.* 4:271–277
- Decraemer, W, and Hunt, DJ. 2006. Structure and classification. In: Perry, RN, and Moens M (eds). *Plant Nematology*. CABI Publ., Wallingford, UK, pp.3-32
- Denli, AM, Tops, BB, Plasterk, RH, Ketting, RF, and Hannon, GJ. 2004. Processing of primary microRNAs by the microprocessor complex. *Nature* 432:231–235
- Devran, Z, and Söğüt, MA. 2010. Occurrence of virulent root-knot nematode isolates on tomatoes bearing the *Mi* gene in protected vegetable-growing areas of Turkey. *Phytopathology Mediterranea* 38:245–251
- Di Laurenzio, L, WysockaDiller, J, Malamy, JE, Pysh, L, Helariutta, Y, Freshour, G, Hahn, MG, Feldmann, KA, and Benfey, PN. 1996. The *SCARECROW* gene regulates an asymmetric cell division that is essential for generating the radial organization of the Arabidopsis root. *Cell* 86:423–433
- Ding, X, Shields, J, Allen, R, and Hussey, RS. 2000. Molecular cloning of a venom allergen AG5-like cDNA from *Meloidogyne incognita*. *Int. J. Parasitol.* 30:77– 81
- Djian-Caporalino, C, Fazari, A, Arguel, MJ, Vernie, T, VandeCastele, C, Faure, I, Brunoud, G, Pijarowski, L, Palloix, A, Lefebvre, V, and Abad, P. 2007. Root-knot nematode (*Meloidogyne spp.*) *Me* resistance genes in pepper (*Capsicum annuum* L.) are clustered on the P9 chromosome. *Theor Appl Genet* 114:473–486
- Doyle, EA, and Lambert, KN. 2002. Cloning and characterization of an esophageal-gland-specific pectate lyase from the root-knot nematode *Meloidogyne javanica*. *Mol. Plant Microbe Interact.* 15:549–556
- Dubreuil, G, Magliano, M, Deleury, E, Abad, P, and Rosso, MN. 2007. Transcriptome analysis of root-knot nematode functions induced in the early stages of parasitism. *New Phytol.* 176:426–436

- Dubreuil, G, Deleury, E, Magliano, M, Jaouannet, M, Abad, P, and Rosso, MN. 2011. Peroxiredoxins from the plant parasitic root-knot nematode, *Meloidogyne incognita*, are required for successful development within the host. *Int. J. Parasitol.* 41:385–396
- Duchaine, TF, Wohlschlegel, JA, Kennedy, S, Bei, Y, Conte, D Jr, Pang, K, Brownell, DR, Harding, S, Mitani, S, Ruvkun, G, Yates, JR III, and Mello, CC. 2006. Functional proteomics reveals the biochemical niche of *C. elegans* DCR-1 in multiple small-RNA-mediated pathways. *Cell* 124:343–354
- Dunoyer, P, Himber, C, and Voinnet, O. 2005. DICER-LIKE4 is required for RNA interference and produces the 21-nucleotide small interfering RNA component of the plant cell-to-cell silencing signal. *Nat Genet* 37:1356–1360
- Dusenbery, DB. 1988. Behavioral response of *Meloidogyne incognita* to small temperature changes. *J. Nematology* 20(3):351-355
- Duxbury, MS, Ashley, SW, and Whang, EE. 2005. RNA interference: a mammalian SID-1 homologue enhances siRNA uptake and gene silencing efficacy in human cells. *Biochem. Biophys. Res. Commun.* 331:459–463
- Eddaoudi, M, Ammati, M, and Rammah, A. 1977. Identification of the resistance breaking populations of *Meloidogyne* on tomatoes in Morocco and their effect on new sources of resistance. *Fundam. Appl. Nematol.* 20:285-289
- English, JJ, Mueller, E, and Baulcombe, DC. 1996. Suppression of virus accumulation in transgenic plants exhibiting silencing of nuclear genes. *The Plant Cell* 8:179–188
- Fagard, M. 2000. AGO1, QDE-2, and RDE-1 are related proteins required for post-transcriptional gene silencing in plants, quelling in fungi, and RNA interference in animals. *Proc Natl Acad Sci USA* 97:11650–11654
- Fairbairn, D, Cavallaro, A, Bernard, M, Mahalinga-Iyer, J, Graham, M, and Botella, J. 2007. Host-delivered RNAi: an effective strategy to silence genes in plant parasitic nematodes. *Planta* 226:1525–1523
- Faktor, O, Kooter, JM, Dixon, RA, and Lamb, CJ. 1996. Functional dissection of a bean chalcone synthase gene promoter in transgenic tobacco plants. *Plant Mol. Biol.* 32:849–859
- Fanelli, E, DiVito, M, Jones, JT, and De Giorgi, C. 2005. Analysis of chitin synthase function in a plant parasitic nematode, *Meloidogyne artiellia*, using RNAi. *Gene* 349:87–95
- Feng, X., and Guang, S. 2013. Small RNAs, RNAi and the inheritance of gene silencing in *Caenorhabditis elegans*. *J Genet Genom* 40:153–160

- Fire, A, Xu, S, Montgomery, MK, Kostas, SA, Driver, SE, and Mello, CC. 1998. Potent and specific genetic interference by double-stranded RNA in *Caenorhabditis elegans*. *Nature* 391:806–811
- Fitch, MMM, Manshardt, RM, Gonsalves, D, Slightom, JL, and Sanford, JC. 1992. Virus resistant papaya plants derived from tissues bombarded with the coat protein gene of papaya ringspot virus. *Nature Biotechnology* 10, 1466–1472
- Fitzgerald, TL, Kazan, K, and Manners, JM. 2012. The application of reverse genetics to polyploid plant species. *Crit. Rev. Plant Sci.* 31:181-200.
- Frizzi, A, and Huang, S. 2010. Tapping RNA silencing pathways for plant biotechnology. *Plant Biotechnol J* 8:655–677
- Fuchs, M, Cambra, M, Capote, N, Jelkmann, W, Kundu, J, Laval, V, Martelli, GP, Minafra, A, Petrovic, N, Pfeiffer, P, Pompe, NM, Ravelonandro, M, Saldarelli, P, Stussi-Garud, C, Vigne, E, and Zagari, I. 2007. Safety assessment of transgenic plums and grapevines expressing viral coat protein genes: new insights into real environmental impact of perennial plants engineered for virus resistance. *J Plant Pathol* 89(1):5–12
- Gal-On, A, Wolf, D, Antignus, Y, Patlis, L, Ryu, K, Min, B, Pearlsman, M, Lachman, O, Gaba, V, Wang, Y, Shibolet, Y, Yang, J, and Zelcer, A. 2005. Transgenic cucumbers harboring the 54-kDa putative gene of Cucumber fruit mottle mosaic tobamovirus are highly resistant to viral infection and protect non-transgenic scions from soil infection. *Transg. Res.* 14:81-93
- Gatz, C, Froberg, C, and Wendenburg, R. 1992. Stringent repression and homogeneous de-repression by tetracycline of a modified CaMV35S promoter in intact transgenic tobacco plants. *Plant J* 2:397-404
- Gatz, C, and Quail, PH. 1988. Tn10-encoded Tet repressor can regulate an operator-containing plant promoter. *Proc Natl Acad Sci USA* 85:1394-1397
- Gheysen, G, and Mitchum, MG. 2011. How nematodes manipulate plant development pathways for infection. *Current Opinion in Plant Biology* 14:415–421
- Goellner, M, Wang, X, and Davis, EL. 2001. Endo- $\beta$ -1,4-glucanase expression in compatible plant–nematode interactions. *Plant Cell* 13:2241–2255
- Goldstein, P, and Triantaphyllou, AC. 1982. The synaptonemal complexes of *Meloidogyne*: relationships of structure and evolution of parthenogenesis. *Chromosoma* 87: 117–124



Groenewald, JH, and Botha, F. 2008. Downregulation of pyrophosphate: fructose 6-phosphate 1-phosphotransferase (PFP) activity in sugarcane enhances sucrose accumulation in immature internodes. *Transgenic Res.* 17:85–92

Gu, SG, Pak, J, Barberan-Soler, S, Ali, M, Fire, A, and Zahler, AM. 2007. Distinct ribonucleoprotein reservoirs for microRNA and siRNA populations in *C. elegans*. *RNA* 13:1492–1504

Guis, M, Roustan, JP, Dogimon, C, Pitrat, M, and Pech, JC. 1998. Melon biotechnology. *Biotechnol. Genet. Engng. Rev.* 15:289–311

Haegeman, A, Mantelin, S, Jones, JT, and Gheysen, G. 2012. Functional roles of effectors of plant-parasitic nematodes. *Gene.* 492:19-31

Hamamouch, N, Li, C, Hewezi, T, Baum, TJ, Mitchum, MG, Hussey, RS, Vodkin, LO, and Davis, EL. 2012. The interaction of the novel 30C02 cyst nematode effector protein with a plant beta-1,3 endoglucanase may suppress host defense to promote parasitism. *Journal of Experimental Botany* 63:3683–3695

Hellens, R, Mullineaux, P, and Klee, H. 2000. Technical Focus: a guide to *Agrobacterium* binary Ti vectors. *Trends Plant Sci* 5:446–451

Hernandez-Garcia, CM, Martinelli, AP, Bouchard, RA, and Finer, JJ. 2009. A soybean (*Glycine max*) polyubiquitin promoter gives strong constitutive expression in transgenic soybean. *Plant Cell Rep* 28:837-849

Hily, JM, Scorza, R, Malinowski, T, Zawadzka, B, and Ravelonandro, M. 2004. Stability of gene silencing-based resistance to Plum pox virus in transgenic plum (*Prunus domestica* L.) under field conditions. *Transgenic Res* 13:427–436

Hily, JM, Scorza, R, Webb, K, and Ravelonandro, M. 2005. Accumulation of the long class of siRNA is associated with resistance to Plum pox virus in a transgenic woody perennial plum tree. *Mol Plant Microbe Interact* 18:794–799

Horsch, RB, Fry, JE, Hoffmann, NL, Eichholtz, D, Rogers, SG, and Fraley, RT. 1985. A simple and general method for transferring genes into plants. *Science* 227:1229–1231

Horton, D, Brannen, P, Bellinger, B, and Ritchie, D. 2007. Southeastern peach, Nectarine and Plum Pest Management and Culture Guide. University of Georgia Cooperative Extension Services Bulletin No 1171, University of Georgia, Athens, GA

Huang, CS. 1985. Formation, anatomy, and physiology of giant cells induced by root-knot nematodes. In: Sasser, JN, and Carter, CC (eds). An advanced treatise on *Meloidogyne*, vol 1, biology and control. North Carolina State University Graphics, Raleigh, NC pp.155-164

- Huang, GZ, Gao, B, Maier, T, Allen, R, Davis, EL, Baum, TJ, and Hussey, RS. 2003. A profile of putative parasitism genes expressed in the esophageal gland cells of the root-knot nematode *Meloidogyne incognita*. *Mol. Plant-Microbe Interact.* 16:376-381
- Huang, GZ, Dong, RH, Allen, R, Davis, EL, Baum, TJ, and Hussey, RS. 2005a. Developmental expression and molecular analysis of two *Meloidogyne incognita* pectate lyase genes. *Int. J. Parasitol.* 35:685–692
- Huang, GZ, Dong, RH, Allen, R, Davis, EL, Baum, TJ, and Hussey, RS. 2005b. Two chorismate mutase genes from the root-knot nematode *Meloidogyne incognita*. *Mol. Plant Pathol.* 6:23–30
- Huang, GZ, Dong, R, Allen, R, Davis, EL, Baum, TJ, and Hussey, RS. 2006. A root-knot nematode secretory peptide functions as a ligand for a plant transcription factor. *Mol. Plant-Microbe Interact.* 19:463–470
- Huang, GZ, Allen, R, Davis, EL, Baum, TJ, and Hussey, RS. 2006. Engineering broad root-knot resistance in transgenic plants by RNAi silencing of a conserved and essential root-knot nematode parasitism gene. *Proc Natl Acad Sci USA* 103(39):14302-14306
- Hunt, DJ, and Handoo, ZA. 2009. Taxonomy, identification, and principal species. In Perry, RN, Moens, M, and Starr, JL (eds). *Root Knot Nematodes*. CABI, Oxfordshire, UK pp.55-97
- Hussey, RS. 1985. Host-parasite relationships and associated physiological changes. In: Sasser, JN, and Carter, CC (eds). *An advanced treatise on Meloidogyne, Vol I, biology and control*. North Carolina State University Graphics, Raleigh, NC, pp. 143-153
- Hussey, RS. 1989. Disease-inducing secretions of plant-parasitic nematodes. *Annu. Rev. Phytopathol.* 27:123-141
- Hussey RS, and Mims CW. 1990. Ultrastructure of esophageal glands and their secretory granules in the root-knot nematode *Meloidogyne incognita*. *Protoplasma* 156:9–18
- Hussey, RS, and Mims, CW. 1991. Ultrastructure of feeding tubes formed in giant cells induced in plants by the root-knot nematode *Meloidogyne incognita*. *Protoplasma* 162:99–107
- Hussey, RS, Davis, EL, and Ray, C. 1994. *Meloidogyne* stylet secretions. In: Bird, DMcK, De Giorgi, C, and Lamberti, F (eds). *Advances in Molecular Plant Nematology*, Plenum Press, New York, NY, USA pp.233–249
- Inan, GZhang, Q, Li, P, Wang, Z, Cao, Z, Zhang, H, Zhang, C, Quist, TM, Goodwin, SM, Zhu, J, Shi, H, Damsz, B, Charbaji, T, Gong, Q, Ma, S, Fredricksen, M, Galbraith, DW, Jenks, MA, Rhodes, D, Hasegawa, PM, Bohnert, HJ, Joly, RJ, Bressan, RA, and Zhu, JK. 2004. Salt cress. A halophyte and cryophyte *Arabidopsis* relative model system and its

applicability to molecular genetic analyses of growth and development of extremophiles. *Plant Physiol.* 135:1718–1737

Jamalkandi, SA, and Masoudi-Nejad, A. 2009. Reconstruction of *Arabidopsis thaliana* fully integrated small RNA pathway. *Funct Integr Genomics* 9(4):419-432

Jaubert, S, Ledger, TN, Laffaire, JB, Piotte, C, Abad, P, and Rosso, MN. 2002. Direct identification of stylet secreted proteins from root-knot nematodes by a proteomic approach. *Mol. Biochem. Parasitol.* 121:112–205

Johnson, AW, and Feldmesser, J. 1987. Nematicides – a historical review. In: Veech, J.A., and Dickson, D.W. (eds.). *Vistas on Nematology*. Society of Nematologists, Hyattsville, Maryland pp.448-454

Jopling, CL, Yi, M, Lancaster, AM, Lemon, SM, and Sarnow, P. 2005. Modulation of hepatitis C virus RNA abundance by a liverspecific microRNA. *Science* 309:1577–1581

Jones, MGK. 1981. Host cell responses to endoparasitic nematode attack: structure and function of giant cells and syncytia. *Ann Appl Biol* 97:353-372

Kaloshian, I., Williamson, V.M., Miyao, G., Lawn, D.A., and Westerdahl, B.B. 1996. Resistance-breaking nematodes identified in California tomatoes. *Calif Agric* 50:18–19

Kamath, RS, Fraser, AG, Dong, Y, Poulin, G, Durbin, R, Gotta, M, Kanapink, A, Bot, NL, Moreno, S, Sohrmann, M, Welchman, DP, Zipperlen, P, and Ahringer, J. 2003. Systematic functional analysis of the *Caenorhabditis elegans* genome using RNAi. *Nature* 421:231–237

Karssen, G, and Moens, M. 2006. Root-knot nematodes. In: Perry, RN, and Moens, M (eds). *Plant Nematology*. CABI Publ., Wallingford, UK, pp.59-90

Kasperbauer, MA, and Collins, GB. 1972. Reconstitution of diploids from leaf tissue of anther-derived haploids in tobacco. *Crop Sci* 12:98-101

Khan, FA. 1985. Root-knot infection in fruit trees in Zaria and environs. *International Nematology Network Newsletter* 2:6-8

Kimber, MJ, McKinney, S, McMaster, S, Day, TA, Fleming, CC, and Maule, AG. 2007. *flp* gene disruption in a parasitic nematode reveals motor dysfunction and unusual neuronal sensitivity to RNA interference. *FASEB J.* 21:1233–1243

Koenning, SR, Overstreet, C, Noling, JW, Donald, PA, Becker, JO, and Fortnum, BA. 1999. Survey of crop losses in response to phytoparasitic nematodes in the United States for 1994. *Supplement to the J. Nematol.* . 31(4S):587-618

- Koncz, C, and Schell, J. 1986. The promoter of TL-DNA gene 5 controls the tissue-specific expression of chimaeric genes carried by a novel type of *Agrobacterium* binary vector. *Molec. Gen. Genet.* 204:383-396
- Krieger, EK, Allen, E, Gilbertson, LA, Roberts, JK, Hiatt, W, and Sanders, RA. 2008. The Flavr Savr Tomato, an early example of RNAi technology. *HortScience* 43:962–964
- Lambert, KN, Allen, KD, and Sussex, IM. 1999. Cloning and characterization of an esophageal-gland-specific chorismate mutase from the phytoparasitic nematode *Meloidogyne javanica*. *Mol. Plant-Microb. Interact.* 12:328–336
- Lanford, RE, Hildebrandt-Eriksen, ES, Petri, A, Persson, R, Lindow, M, Munk, ME, Kauppinen, S, and Ørum, H. 2010. Therapeutic silencing of microRNA-122 in primates with chronic hepatitis C virus infection. *Science* 327:198-201
- Lares, MR, Rossi, JJ, and Ouellet, DL. 2010. RNAi and small interfering RNAs in human disease therapeutic applications. *Trends Biotechnol.* 28:570–579
- Leach, F, and Aoyagi, K. 1991. Promoter analysis of the highly expressed *rolC* and *rolD* root-inducing genes of *Agrobacterium rhizogenes*: enhancer and tissue-specific DNA determinants are dissociated. *Plant Sci.* 79:69–76
- Ledger, TN, Jaubert, S, Bosselut, N, Abad, P, and Rosso, MN. 2006. Characterization of a new beta-1,4-endoglucanase gene from the root-knot nematode *Meloidogyne incognita* and evolutionary scheme for phytonematode family 5 glycosyl hydrolases. *Gene* 382:121–128
- Lee, Y, Ahn, C, Han, J, Choi, H, Kim, J, Yim, J, Lee, J, Provost, P, Radmark, O, Kim, S, and Kim, VN. 2003. The nuclear RNase III Drosha initiates microRNA processing. *Nature* 425:415–419
- Li, J, Todd, TC, Oakley, TR, Lee, J, and Trick, HN. 2010. Host-derived suppression of nematode reproductive and fitness genes decreases fecundity of *Heterodera glycines*. Ichinohe. *Planta* 232:775–785
- Li, J, Yang, Z, Yu, B, Liu, J, and Chen, X. 2005. Methylation protects miRNAs and siRNAs from a 3 prime-end uridylation activity in Arabidopsis. *Curr Biol* 15:1501–1507
- Lindbo, JA, and Dougherty, WG. 2005. Plant pathology and RNAi: a brief history. *Annu. Rev. Phytopathol.* 43:191–204
- Lindbo, JA, Silva-Rosales, L, Proebsting, WM, and Dougherty, WG. 1993. Induction of a highly specific antiviral state in transgenic plants: implications for regulation of gene expression and virus resistance. *Plant Cell* 5:1749–1759

- Lund, E, Guttinger, S, Calado, A, Dahlberg, JE, and Kutay, U. 2004. Nuclear export of microRNA precursors. *Science* 303:95–98
- Ma, JB, Yuan, YR, Meister, G, Pei, Y, Tuschl, T, and Patel, DJ. 2005. Structural basis for 5'-end-specific recognition of guide RNA by the *A. fulgidus* Piwi protein. *Nature* 434:666–670
- Malinowski, T, Cambra, M, Capote, N, Gorris, MT, Scorza, R, and Ravelonandro, M. 2006. Field trials of plum clones transformed with the Plum pox virus coat protein (PPV-CP) clone. *Plant Dis.* 90:1012—1018
- McClure, MA. 1977. *Meloidogyne incognita*: a metabolic sink. *J Nematol* 9:88-90
- McGinnis, K, Chandler, V, Cone, K, Kaeppler, H, Kaeppler, S, Kerschen, A, Pikaard, C, Richards, E, Sidorenko, L, Smith, T, Springer, N, and Wulan, T. 2005. Transgene-induced RNA interference as a tool for plant functional genomics. *Methods Enzymol* 392:1–24
- Meister, G. and Tuschl, T. 2004. Mechanisms of gene silencing by double-stranded RNA. *Nature* 431:343–349
- Mitchum, MG, Hussey, RS, Baum, TJ, Wang, XH, Elling, AA, Wubben, M, and Davis, EL. 2013. Nematode effector proteins: an emerging paradigm of parasitism. *New Phytologist* 199(4):879-894
- Mitreva-Dautova, M, Roze, E, Overmars, H, de Graaff, L, Schots, A, Helder, J, Goverse, A, Bakker, J, and Smant, G. 2006. A symbiont-independent endo-1,4-beta-xylanase from the plant-parasitic nematode *Meloidogyne incognita*. *Mol. Plant Microbe Interact.* 19:521–529
- Nachay, K. 2013. Three win World Food Prize. *Food technology* 67(8):13-13
- Napoli, C, Lemieux, C, and Jorgensen, R. 1990. Introduction of a chimeric chalcone synthase gene into petunia results in reversible co-suppression of homologous genes in trans. *Plant Cell* 2:279–289
- Nehra, NS, Chibbar, RN, Kartha, KK, Datla, RSS, Crosby, WL, and Stushnoff, C. 1990. Genetic transformation of strawberry by *Agrobacterium tumefaciens* using a leaf disk regeneration system. *Plant Cell Rep.* 9:293–298
- Nehra, NS, Stushnoff, C, and Kartha, KK. 1989. Direct shoot regeneration from strawberry leaf disks. *J. Am. Soc. Hort. Sci.* 114:1014–1018
- Nielsen, H, Engelbrecht, J, Brunak, S, and von Heijne, G. 1997. Identification of prokaryotic and eukaryotic signal peptides and prediction of their cleavage sites. *Protein Eng.* 10:1–6

- Nyczepir, AP, and Thomas, SH. 2009. Current and future management strategies in intensive crop production systems. In: Perry, RN, Moens, M, and Starr, JL (eds). Root-Knot Nematodes. CABI Publ., Wallingford, UK pp.412-443
- Odell, JT, Nagy, F, and Chua, NH. 1985. Identification of DNA sequences required for activity of the cauliflower mosaic virus 35S promoter. *Nature* 313:810-812
- Opperman, CH, Bird, DM, Williamson, VM, Rokhsar, DS, Burke, M, Cohn, J, Cromer, J, Diener, S, Gajan, J, Graham, S, Houfek, TD, Liu, Q, Mitros, T, Schaff, J, Schaffer, R, Scholl, E, Sosinski, BR, Thomas, VP, and Windham, E. 2008. Sequence and genetic map of *Meloidogyne hapla*: a compact nematode genome for plant parasitism. *Proc. Natl. Acad. Sci. USA* 105:14802–14807
- Opperman, CH, and Chang, S. 1990. Plant-parasitic nematode acetylcholinesterase inhibition by carbamate and organophosphate nematicides. *J. Nematol.*, 22:481–488
- Opperman, CH, Taylor, CG, and Conkling, MA. 1994. Root-knot nematode-directed expression of a plant root-specific gene. *Science* 263(5144):221-223
- Pacurar, DI, Thordal-Christensen, H, Pacurar, ML, Pamfil, D, Botez, C, and Bellini, C. 2011. *Agrobacterium tumefaciens*: from crown gall tumors to genetic transformation. *Physiol Mol Plant Pathol* 76:76–81
- Paddison, PJ. 2008. RNA interference in mammalian cell systems. *Curr. Top. Microbiol. Immunol.* 320:1–19
- Park, MY, Wu, G, Gonzalez-Sulser, A, Vaucheret, H, and Poethig, RS. 2005. Nuclear processing and export of micro-RNAs in Arabidopsis. *Proc Natl Acad Sci USA* 102:3691–3696
- Parker, JS, Roe, SM, and Barford, D. 2005. Structural insights into mRNA recognition from a PIWI domain-siRNA guide complex. *Nature* 434:663–666
- Parry, DH, Xu, J, and Ruvkun, G. 2007. A whole-genome RNAi Screen for *C. elegans* miRNA pathway genes. *Curr. Biol.* 17:2013–2022
- Patel, N, Hamamouch, N, Li, C, Hewezi, T, Hussey, RS, Baum, TJ, Mitchum, MG, and Davis, EL. 2010. A nematode effector protein similar to annexins in host plants. *Journal of Experimental Botany* 61:235–248
- Patel, N, Hamamouch, N, Li, C, Hussey, R, Mitchum, M, Baum, T, Wang, X, and Davis, EL. 2008. Similarity and functional analyses of expressed parasitism genes in *Heterodera schachtii* and *Heterodera glycines*. *J. Nematol.* 40:299–310

- Pline, M, and Dusenbery, DB. 1987. Responses of plant-parasitic nematode *Meloidogyne incognita* to carbon dioxide determined by video camera-computer tracking. *J. Chem. Ecol.* 13(4):873–888
- Pline, M, Diez, JA, and Dusenbery, DB. 1988. Extremely sensitive thermotaxis of the nematode *Meloidogyne incognita*. *J Nematol.* 20:605–608
- Potenza, C, Aleman, L, and Sengupta-Gopalan, C. 2004. Targeting transgene expression in research, agricultural, and environmental applications: promoters used in plant transformation. *In Vitro Cell. Dev. Biol. Plant* 40:1–22
- Prot, JC. 1980. Migration of plant-parasitic nematodes towards plant roots. *Revue. Nematol.* 3:305-318
- Qing, CM, Fan, L, Lei, Y, Bouchez, D, Tourneur, C, Yan, L, and Robaglia, C. 2000. Transformation of pakchoi (*Brassica rapa* L. ssp. *Chinensis*) by *Agrobacterium* infiltration. *Mol Breed* 6:67–72
- Raski, DJ, and Krusberg, LR. 1984. Nematode parasites of grapes and other small fruits. In: Nickle, WR (ed). *Plant and Insect Nematodes*. Marcel Dekker, New York,. pp.457-506
- Ravelonandro, M, Scorza, R, Bachelier, JC, Labonne, G, Levy, L, Damsteegt, V, Callahan, AM, and Dunez, J. 1997. Resistance of transgenic *Prunus domestica* to plum pox virus infection. *Plant Dis* 81: 1231–1235
- Rosso, MN, Favery, B, Piotte, C, Arthaud, L, de Boer, JM, Hussey, RS, Bakker, J, Baum, TJ, and Abad, P. 1999. Isolation of a cDNA encoding a beta-1,4-endoglucanase in the root-knot nematode *Meloidogyne incognita* and expression analysis during plant parasitism. *Mol Plant Microbe Interact* 12:585-591
- Rosso, MN, Hussey, RS, Davis, EL, Smant, G, Baum, TJ, Abad, P, and Mitchum, MG. 2012. Nematode effector proteins: targets and functions in plant parasitism. In: Martin, F, and Kamoun, S (eds). *Effectors in Plant-Microbe Interactions*. Wiley-Blackwell, New York: pp. 329–56
- Rosso, MN, Jones, JT, and Abad, P. 2009. RNAi and Functional Genomics in Plant Parasitic Nematodes. *Annu. Rev. Phytopathol.* 47(1):207-232
- Roze, E, Hanse, B, Mitreva, M, Vanholme, B, Bakker, J, and Smant, G. 2008. Mining the secretome of the root-knot nematode *Meloidogyne chitwoodi* for candidate parasitism genes. *Mol. Plant Pathol.* 9:1–10
- Ruppenhorst, HJ. 1984. Intracellular feeding tubes associated with sedentary plant parasitic nematodes. *Nematologica* 30:77-85

- Sasser, JN. 1980. Root-knot nematodes: a global menace to crop production. *Plant Dis.* 64:36-41
- Sasser, JN, Eisenback, JD, Carter, CC, and Triantaphyllou, AC. 1983. The International *Meloidogyne* project - its goals and accomplishments. *Annu Rev Phytopathol* 21:271–288
- Sasser, JN, and Freckman, DW. 1987. A world perspective on nematology: the role of the society. In: Veech, J.A., and Dickerson, D.W. (eds.) *Vistas on Nematology*, Society of Nematologists Hyatsville, USA pp.7–14
- Sayre, RM, and Starr, MP. 1985. *Pasteuria penetrans* (ex Thorne, 1940) nom. rev., comb. n., sp. n., a mycelial and endospore-forming bacterium parasitic in plant-parasitic nematodes. *Proc Helminthol Soc Wash* 52:149–165
- Scheres, B, Di Laurenzio, L, Willemsen, V, Hauser, MT, Janmaat, K, Weisbeek, P, and Benfey, PN. 1995. Mutations affecting the radial organization of the *Arabidopsis* root display specific defects throughout the embryonic axis. *Development* 121:53–62
- Scorza, R, Ravelonandro, M, Callahan, AM, Cordts, JM, Fuchs, M, Dunez, J, and Gonsalves, D. 1994. Transgenic plums (*Prunus domestica*) express the plum pox virus coat protein gene. *Plant Cell Rep.* 14:18-22
- Senthil-Kumar, M, Hema, R, Suryachandra, TR, Ramegowda, HV, Gopalakrishna, R, Rama, N, Udayakumar, M, and Mysore, K. S. 2010. Functional characterization of three water deficit stress-induced genes in tobacco and *Arabidopsis*: An approach based on gene down regulation. *Plant Physiol. Biochem.* 48:35–44
- Shabalina, SA, and Koonin, EV. 2008. Origins and evolution of eukaryotic RNA interference. *Trends in Ecology and Evolution* 23:578–587
- Sheth, U, and Parker, R. 2003. Decapping and decay of messenger RNA occur in cytoplasmic processing bodies. *Science* 300:805–808
- Siddiqui, ZA, and Mahmood, I. 1996. Biological control of plant parasitic nematodes by fungi: a review. *Bioresource Technol* 58:229–239
- Sijen, T, Fleenor, J, Simmer, F, Thijssen, KL, Parrish, S, Timmons, L, Plasterk, RH, and Fire, A. 2001. On the role of RNA amplification in dsRNA-triggered gene silencing. *Cell* 107:465–476
- Sijmons, PC, Atkinson, HJ, and Wyss, U. 1994. Parasitic strategies of root nematodes and associated host cell responses. *Annu. Rev. Phytopathol.* 32: 235–259



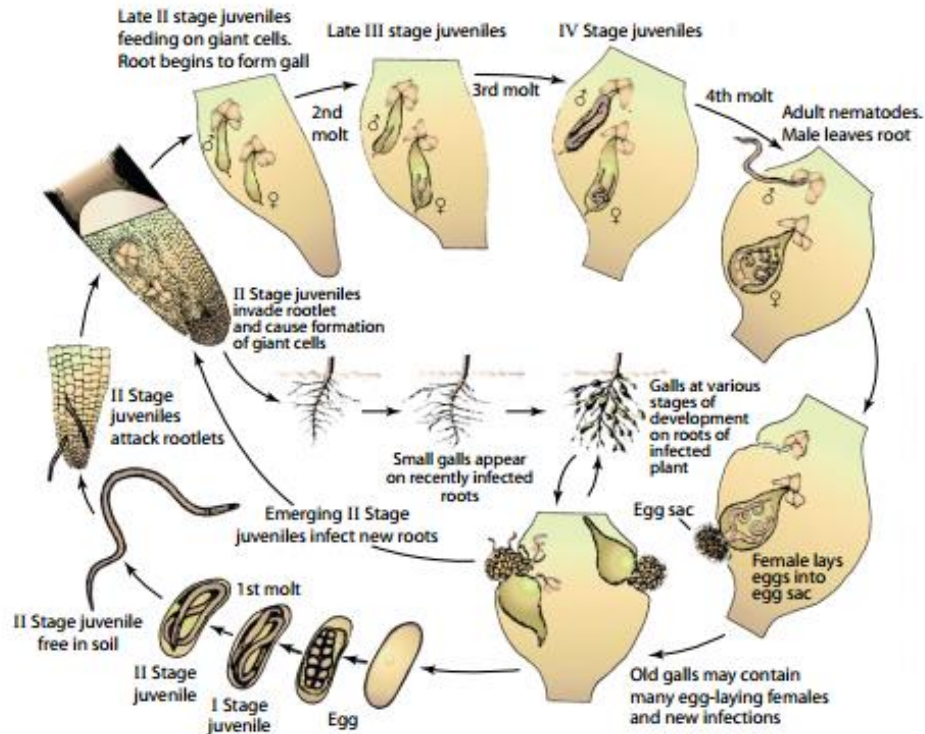
- Sindhu, AS, Maier, TR, Mitchum, MG, Hussey, RS, Davis, EL, and Baum, TJ. 2009. Effective and specific in planta RNAi in cyst nematodes: expression interference of four parasitism genes reduces parasitic success. *J Exp Bot.* 60:315–324
- Singh, SK, and Hajeri, PB. 2009. siRNAs: their potential as therapeutic agents—part II. Methods of delivery. *Drug Discov. Today* 14:859–865
- Small, I. 2007. RNAi for revealing and engineering plant gene functions. *Curr. Opin. Biotechnol.* 18:148–153
- Smardon, A, Spoerke, JM, Stacey, SC, Klein, ME, Mackin, N, and Maine, EM. 2000. EGO-1 is related to RNA-directed RNA polymerase and functions in germ-line development and RNA interference in *C. elegans*. *Curr. Biol.* 10:169–178
- Smith, EF, and Townsend, CO. 1907. A plant-tumour of bacterial origin. *Science* 24:671-673
- Smith, NA, Singh, SP, Wang, MB, Stoutjesdijk, PA, Green, AG, and Waterhouse, PM. 2000. Gene expression - Total silencing by intron-spliced hairpinRNAs. *Nature* 407:319–320
- Steeves, RM, Todd, TC, Essig, JS, and Trick, HN. 2006. Transgenic soybeans expressing siRNAs specific to a major sperm protein gene suppress *Heterodera glycines* reproduction. *Funct. Plant Biol.* 33:991-999
- Sundermann, CA, and Hussey, RS. 1988. Ultrastructural cytochemistry of secretory granules of esophageal glands of *Meloidogyne incognita*. *J. Nematol.* 20:141-149
- Tabara, H, Grishok, A, and Mello, CC. 1998. RNAi in *C. elegans*: Soaking in the gene sequence. *Science* 282:430-431
- Tabara, H, Sarkissian, M, Kelly, WG, Fleenor, J, Grishok, A, Timmons, L, Fire, A, and Mello, CC. 1999. The *rde-1* gene, RNA interference, and transposon silencing in *C. elegans*. *Cell* 99:123–132
- Tabara, H, Yigit, E, Siomi, H, and Mello, CC. 2002. The dsRNA binding protein RDE-4 interacts with RDE-1, DCR-1, and a DExH-Box helicase to direct RNAi in *C. elegans*. *Cell* 109:861–871
- Taylor, AL, Sasser, JN, and Nelson, LA. 1982. Relationship of Climate and Soil Characteristics to Geographical Distribution of *Meloidogyne* Species in Agricultural Soils. Cooperative Publication, Department of Plant Pathology, North Carolina State University and US Agency for International Development, Raleigh, North Carolina.
- Tijsterman, M, May, RC, Simmer, F, Okihara, KL, and Plasterk, RH. 2004. Genes required for systemic RNA interference in *Caenorhabditis elegans*. *Curr Biol* 14:111–116

- Timmons, L, Court, DL, and Fire, A. 2001. Ingestion of bacterially expressed dsRNAs can produce specific and potent genetic interference in *Caenorhabditis elegans*. *Gene* 263:103–112
- Tzortzakakis, EA, Adam, MAM, Blok, VC, Paraskevopoulos, C, and Bourtzis, K. 2005. Occurrence of resistance-breaking isolates of root-knot nematodes on tomato in Greece. *European Journal of Plant Pathology* 113:101–105
- Valentine, L. 2003. *Agrobacterium tumefaciens* and the plant: the David and Goliath of modern genetics. *Plant Physiol.* 133:948-955
- van der Krol, AR, Mur, LA, Beld, M, Mol, JNM, and Stuitje, AR. 1990. Flavonoid genes in petunia: addition of a limited number of gene copies may lead to a suppression of a gene expression. *Plant Cell* 2:291–299
- van der Merwe, M, Groenewald, JH, Stitt, M, Kossmann, J, and Botha, F. 2010. Downregulation of pyrophosphate: d-fructose-6-phosphate 1-phosphotransferase activity in sugarcane culms enhances sucrose accumulation due to elevated hexose-phosphate levels. *Planta* 231:595–608
- Van Larebeke, N, Genetello, C, Schell, J, Schilperoort, RA, Hermans, AK, Van Montagu, M, and Hernalsteens, JP. 1975. Acquisition of tumour-inducing ability by non-oncogenic agrobacteria as a result of plasmid transfer. *Nature* 255(5511):742–743
- Vieira, P, Danchin, EGJ, Neveu, C, Crozat, C, Jaubert, S, Hussey, RS, Engler, G, Abad, P, de Almeida-Engler, J, Castagnone-Sereno, P, and Rosso, MN. 2011. The plant apoplast is an important recipient compartment for nematode secreted proteins. *J. Exp. Bot.* 62:1241–1253
- Wang, X, Allen, R, Ding, X, Goellner, M, Maier, T, de Boer, JM, Baum, TJ, Hussey, RS, and Davis, EL. 2001. Signal peptide selection of cDNA cloned directly from the esophageal gland cells of the soybean cyst nematode, *Heterodera glycines*. *Mol. Plant-Microbe Interact.* 14:536-544
- Wang, C, Matthews, WC, and Roberts, PA. 2006. Phenotypic expression of *rkn1*-mediated *Meloidogyne incognita* resistance in *Gossypium hirsutum* populations. *J. Nematol.* 38:250–257
- Wang, WC, Menon, G, and Hansen, G. 2003. Development of a novel *Agrobacterium*-mediated transformation method to recover transgenic *Brassica napus* plants. *Plant Cell Rep* 22:274–281
- Wang, XH, Replogle, A, Davis, EL, and Mitchum, MG. 2007. The tobacco *Cel7* gene promoter is auxin-responsive and locally induced in nematode feeding sites of heterologous plants. *Molecular Plant Pathology* 8(4):423-436

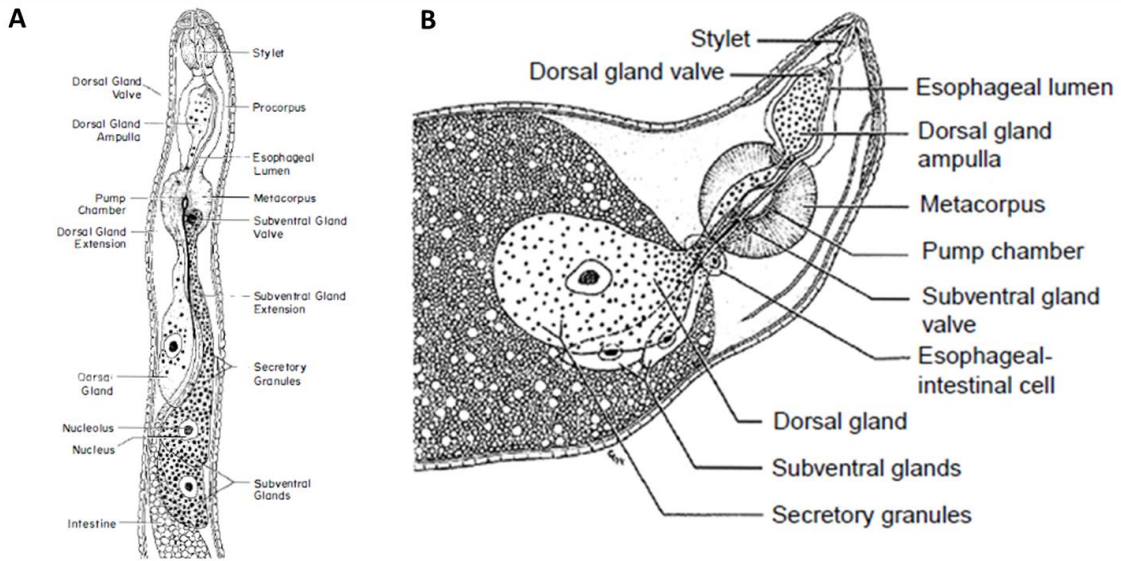
- Weising, K, Schell, J, and Kahl, G. 1988. Foreign genes in plants: transfer, structure, expression, and applications. *Ann. Rev. Genet.* 22:421-477
- Wesley, SV, Helliwell, CA, Smith, NA, Wang, MB, Rouse, DT, Liu, Q, Gooding, PS, Singh, SP, Abbott, D, Stoutjesdijk, PA, Robinson, SP, Gleave, AP, Green, AG, and Waterhouse, PM. 2001. Construct design for efficient, effective and high-throughput gene silencing in plants. *Plant J* 27:581–590
- Wightman, B, Ha, I, and Ruvkun, G. 1993. Posttranscriptional regulation of the heterochronic gene *lin-14* by *lin-4* mediates temporal pattern formation in *C. elegans*. *Cell* 75:855–862
- Williamson, VM, and Roberts, PA. 2009. Mechanisms and genetics of resistance. In: Perry, RN, Moens, M, and Starr, JL (eds). *Root-Knot Nematodes*. CABI Publ., Wallingford, UK pp. 301-325
- Winston, WM, Molodowitch, C, and Hunter, CP. 2002. Systemic RNAi in *C. elegans* requires the putative transmembrane protein SID-1. *Science* 295:2456–2459.
- Wyss, U. 1992. Observations on the feed-ing behaviour of *Heterodera schachtii* throughout development, including events during moulting. *Fund. Appl. Nematol.* 15:75-89
- Wyss, U, Munch, A, and Grundler, FMW. 1992. The parasitic behaviour of second-stage juveniles of *Meloidogyne incognita* in roots of *Arabidopsis thaliana*. *Nematologica* 38:98–111
- Wyss, U, and Zunke U. 1986. Observations on the behaviour of second stage juveniles of *Heterodera schachtii* inside host roots. *Rev. Nematol.* 9:153-165
- Yadav, BC, Veluthambi, K, and Subramaniam, K. 2006. Host-generated double stranded RNA induces RNAi in plant-parasitic nematodes and protects the host from infection. *Mol Biochem Parasitol.* 148:219–222
- Yaghoobi, J, Kaloshia, I, Wen, Y, Williamson, VM. 1995. Mapping a new nematode resistance locus in *Lycopersicon peruvianum*. *Theor. Appl. Genet.* 91(3):457-464
- Yigit, E, Batista, PJ, Bei, Y, Pang, KM, Chen, CC, Tolia, NH, Joshua-Tor, L, Mitani, S, Simard, MJ, and Mello, CC. 2006. Analysis of the *C. elegans* Argonaute family reveals that distinct Argonautes act sequentially during RNAi. *Cell* 127:747–757
- Yi, HY, Rufty, RC, Wernsman, EA, and Conkling, MC. 1998. Mapping the root-knot nematode resistance gene (*RK*) in tobacco with RAPD markers. *Plant Dis.* 82:1319–1322
- Yi, R, Qin, Y, Macara, IG, and Cullen, BR. 2003. Exportin-5 mediates the nuclear export of premicroRNAs and short hairpin RNAs. *Genes Dev.* 17:3011–3016

Zhou, H, Xu, M, Huang, Q, Gates, AT, Zhang, XD, Castle, JC, Stec, E, Ferrer, M, Strulovici, B, Hazuda, DJ, and Espeseth, AS. 2008. Genome-scale RNAi screen for host factors required for HIV replication. *Cell Host Microbe* 4:495–504

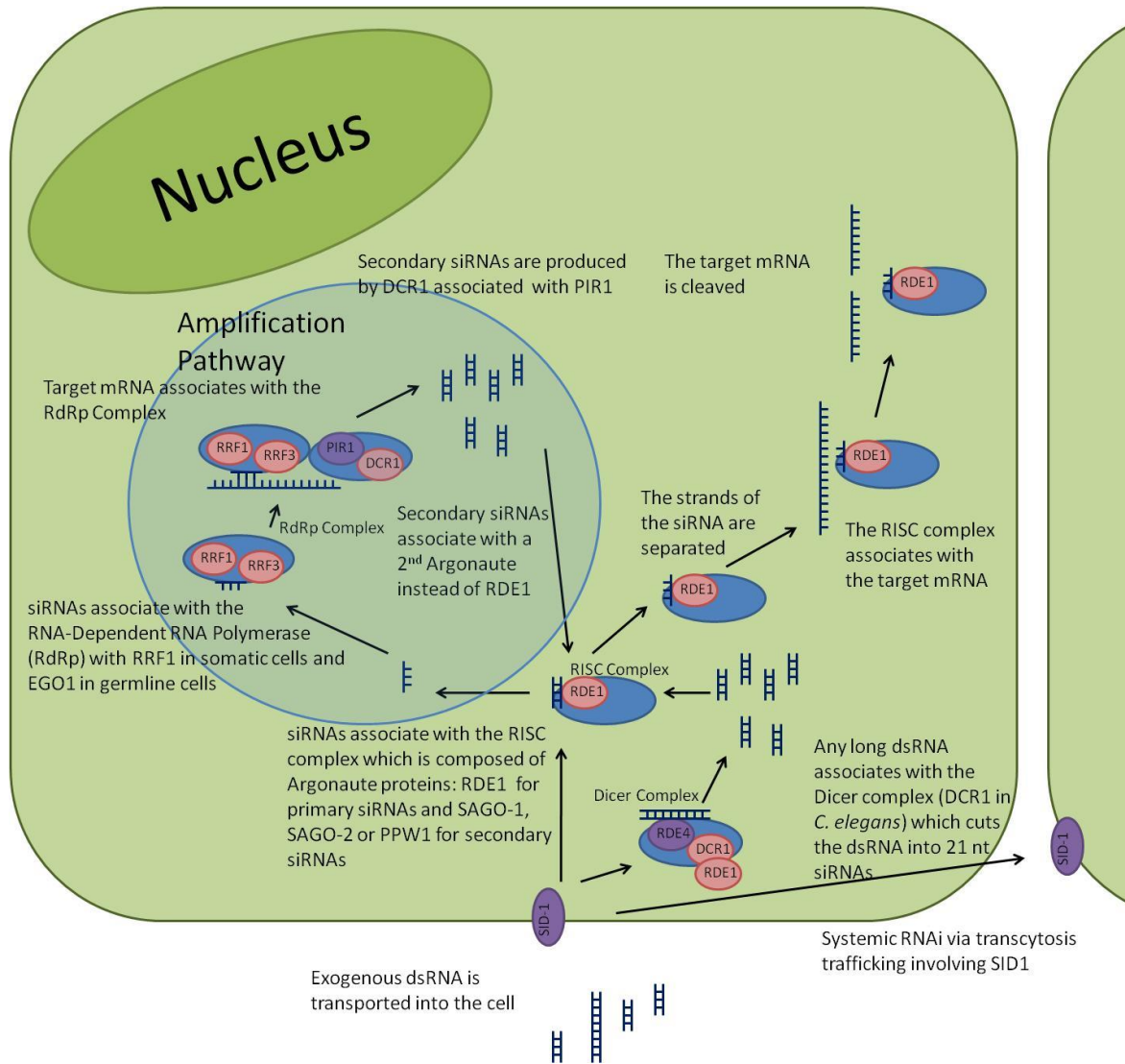
Zuo, J, and Chua, NH. 2000. Chemical-inducible systems for regulated expression of plant genes. *Curr. Opin. Biotechnol.* 11:146–151



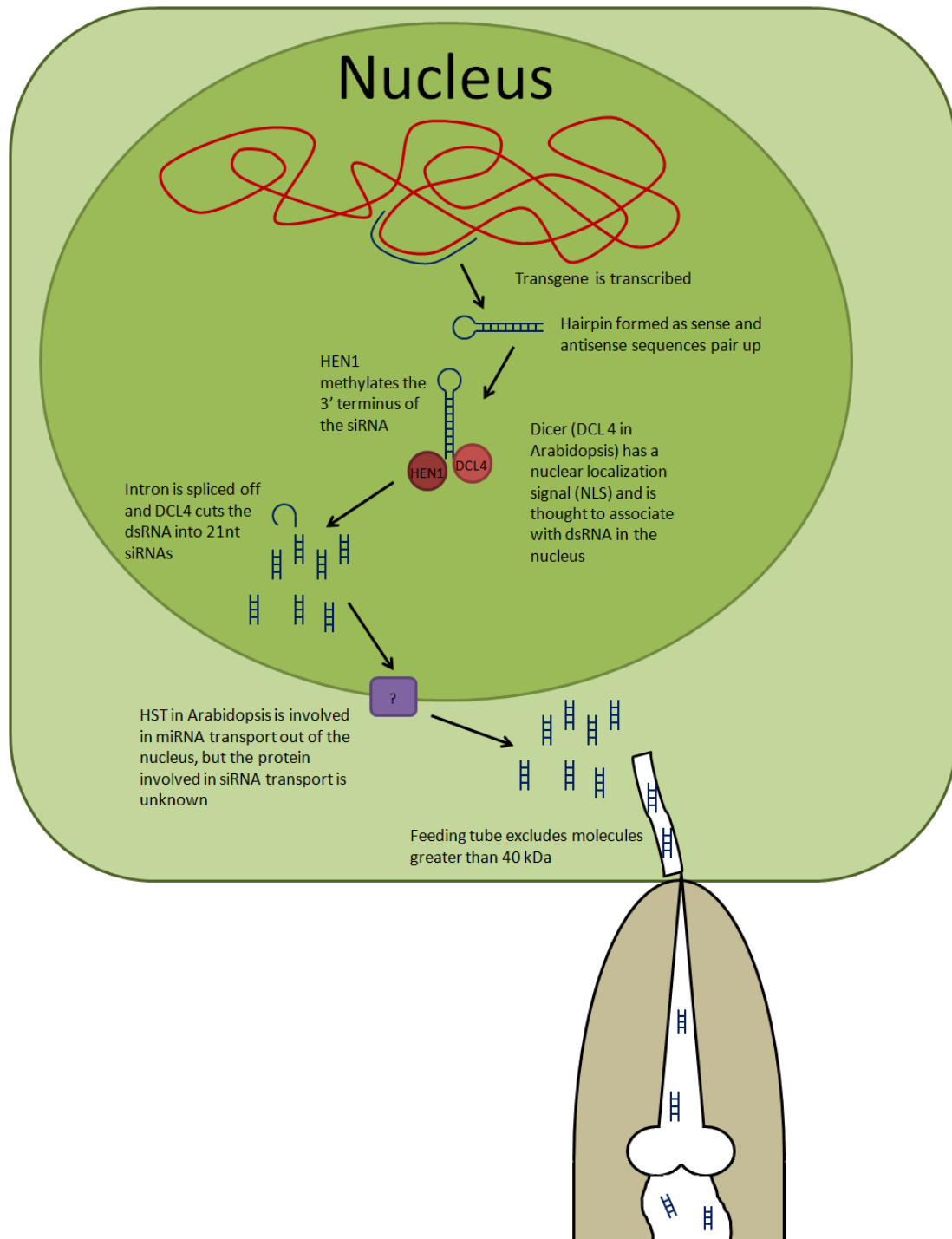
**Figure 1. Life cycle of the root-knot nematode.** The first stage juvenile undergoes the 1<sup>st</sup> molt in the egg and hatches as a second-stage juvenile (J2). The J2 migrates to the rootlets and invades, then sets up a feeding site comprised of several giant-cells. The nematode continues to molt inside the root. Adult male nematodes leave the root while females become pyriform and will lay eggs into an egg sac, which may protrude from the root surface or be imbedded in the root. (Reproduced from Agrios, 2005)



**Figure 2. Esophageal gland cells of plant parasitic nematodes.** **A.** Esophageal glands of a pre-infective second-stage juvenile. Note the greater number of secretory granules in the subventral glands as compared to the dorsal gland. (Reproduced from Hussey, 1989) **B.** Esophageal glands of a late stage parasitic female nematode. Note the enlarged dorsal gland and the reduction of secretory granules in the subventral glands (Reproduced from Hussey et al., 1994).

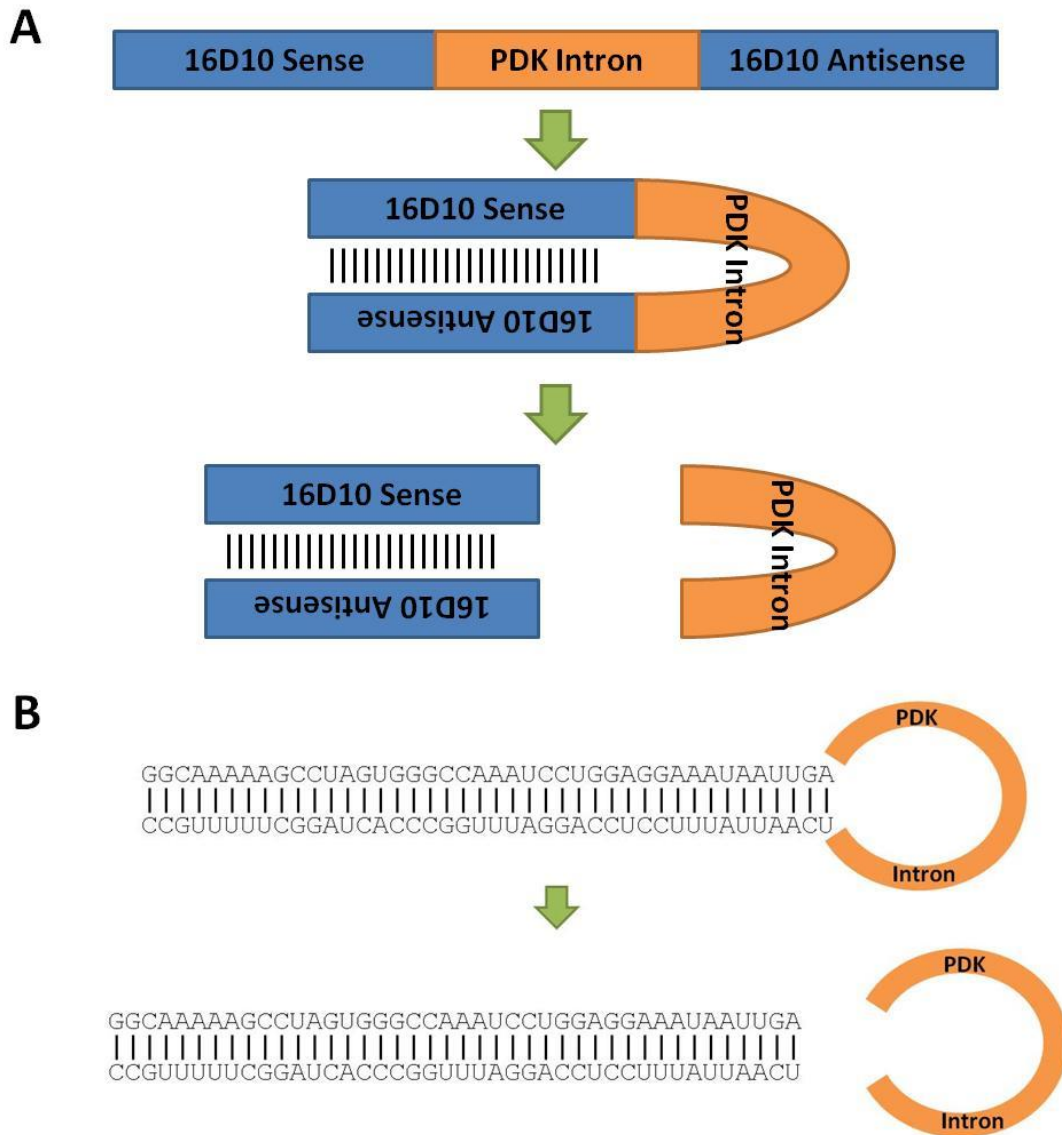


**Figure 3. A model for the mechanism of exogenous RNA interference (RNAi) in a nematode cell.** Orthologs of the genes corresponding to the proteins that are pink in color have been shown to be present in the genome of *Meloidogyne incognita* as well as in *Caenorhabditis elegans*, while those in purple have only been identified in *C. elegans*. The light blue circle highlights the amplification pathway and darker blue circles represent protein complexes. Note that this model is not to scale.

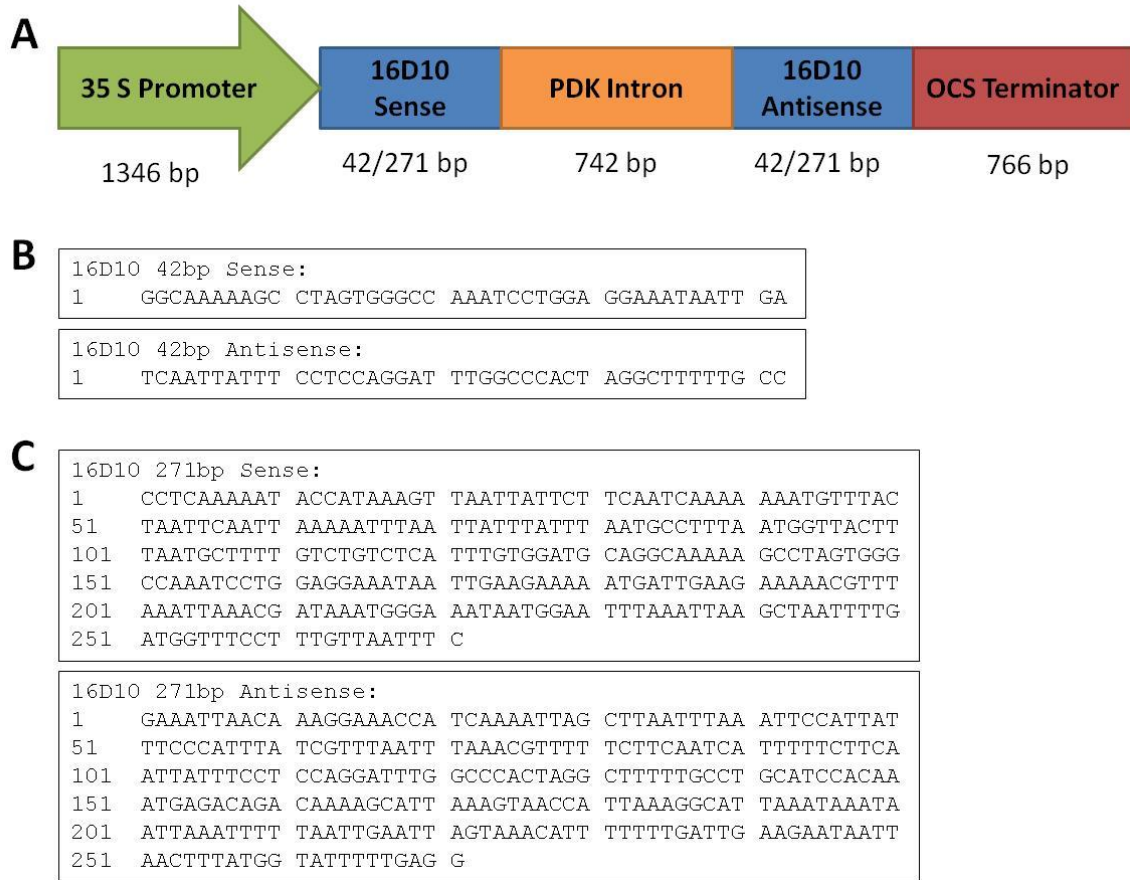


**Figure 4. Model for expression of host-derived RNA interference against *Meloidogyne spp.* and predicted siRNA ingestion by the nematode.** The predicted mechanism by which the hairpin transgene is expressed and processed in order to produce the siRNA that are taken up by the nematode during feeding is shown. This model is not to scale.





**Figure 5. Structure of the RNA produced by the 16D10-RNAi constructs.** **A.** The RNA that is transcribed from the 16D10RNAi construct folds so that the sense and antisense sequences base pair to form a hairpin structure. The intron loop at the end of the hairpin should then be spliced off, resulting in the 16D10 dsRNA. **B.** Example of hairpin structure that would be formed from the 16D10-RNAi-I construct and the splicing event that would result in the 16D10-RNAi-I dsRNA.



**Figure 6. Design of the transgene used for RNAi against the 16D10 gene, as designed by Huang et al. (2006, PNAS).** **A.** The design for the 16D10-RNAi construct used for RNA interference against the *Meloidogyne incognita* 16D10 gene. **B.** The 42bp sense and antisense sequences used in the 16D10-RNAi-1 construct. **C.** The 271bp sense and antisense sequences used in the 16D10-RNAi-2 construct.

# TRANSFORMATION OF TOBACCO FOR siRNA DERIVED RESISTANCE TO ROOT-KNOT NEMATODE

## Abstract

Members of the genus *Meloidogyne*, Root-knot nematodes (RKN), are sedentary plant-parasites that can infect more than 2,000 plant species and cause billions of dollars of damage in crop losses worldwide. These nematodes secrete proteins produced in specialized esophageal gland cells into recipient host plant root cells, transforming them into multinucleate giant-cells that are essential for nematode feeding. One of the secreted effectors is encoded by the *16D10* parasitism gene of *Meloidogyne incognita*. Previous studies have shown that 16D10 is involved in giant-cell formation, and host-derived RNA interference (RNAi) against the *16D10* transcript in *Arabidopsis thaliana* resulted in resistance to the four major species of RKN (Huang et al., 2006b). The research described here details the creation of transgenic tobacco expressing the 16D10RNAi constructs created by Huang et al. (2006). Haploid plants of the *Nicotiana tabacum* cultivars TN90 (burley) and Hicks (flue-cured) were transformed with the 16D10-RNAi constructs and homozygous doubled haploids lines were produced. Successful transformants were selected using kanamycin resistance and were checked for the presence of the full construct by PCR of genomic DNA extracted from the transgenic tobacco, resulting in the production of 36 transformed lines. Expression of siRNA in the transgenic tobacco was confirmed by RT-PCR of the PDK intron of 16D10RNAi constructs and high-throughput siRNA Ion Proton sequencing. Several lines of the transgenic tobacco were found to be significantly more

resistant to root-knot nematodes than wild-type untransformed controls. A maximum of 62% reduction in *Meloidogyne arenaria* egg production and a maximum of 52% reduction in *M. incognita* egg production were observed in TN90 16D10RNAi tobacco roots, and a maximum of 73% reduction in egg production of *M. arenaria* was observed in roots of Hicks 16D10RNAi tobacco plants.

## **Introduction**

Root-knot nematodes are members of the genus *Meloidogyne*, and are probably the most economically important nematodes in agriculture, with estimates of worldwide crop losses at 10 billion dollars per year (Chitwood, 2003). These microscopic roundworms generally have wide host ranges, and can parasitize more than 2,000 plant species, including tobacco (Sasser, 1980). A survey of US crop losses due to plant parasitic nematodes in 1994 (Koenning et al., 1999) reported that North Carolina tobacco growers lost around a million dollars in 1994 due to root-knot nematode infections. Of the more than 70 described species of *Meloidogyne*, the four most economically important species are *M. incognita* (Southern root-knot nematode), *M. javanica* (Javanese root-knot nematode), *M. arenaria* (peanut root-knot nematode), and *M. hapla* (Northern root-knot nematode) (Sasser et al., 1983). Root-knot nematodes are sedentary endoparasites that penetrate plant roots as motile second-stage juveniles and then move intercellularly to the vascular bundles to establish a feeding site. These feeding sites are comprised of several giant-cells, which are multinucleate hypertrophic plant cells that have been modified by the nematode and arise from karyokinesis without cytokinesis (Huang, 1985; Hussey, 1985). Hyperplasia of the cells

surrounding the giant-cells also occurs and galls are formed. These infection sites are nutrient sinks that can cause stunting and reduced yields in the host plant. They also disrupt translocation and can predispose the roots to secondary infections by other pathogens (Mayol and Bergeson, 1970). Once the feeding site is established, the immature nematode will feed, become pyriform, and most of its somatic muscles will atrophy as it becomes sedentary through subsequent juvenile stages to reproductive maturity (Davis et al., 2000). The life cycle is about one month, and adult females usually lay 500 to 1000 eggs. Root-knot nematodes feed from giant-cells by penetrating the cell wall with their stylet, a hollow oral spear. They then secrete effector proteins from their esophageal gland cells into the plant cell through the stylet (Bird and Saurer, 1967; Bird, 1968; Sundermann and Hussey, 1988). The secreted proteins are thought to be involved in giant cell formation (Hussey, 1989; Davis et al., 2004). Since the giant-cells become a permanent feeding site for the sedentary nematode life stages, proper formation and maintenance of the feeding site via the secreted nematode effector proteins is critical to a successful parasitic interaction and subsequent nematode reproduction.

In order to identify effector proteins in the root-knot nematode secretome, Huang et al. (2003) microaspirated the gland cells of 10 different stages of root-knot nematode and created gland cell cDNA libraries. After EST sequence analysis, 37 putative parasitism genes were identified. One of these genes, *16D10*, was localized to the subventral glands cells using immunolocalization and was expressed in both second-stage juveniles and later life stages. This gene encoded a small novel mature peptide only 13aa in length, less than half the size of its secretion signal peptide (30 aa), and was of particular interest since the

subventral glands are usually less active in parasitic stages within the host. Protein dot blots and ELISA of stylet secretions showed that the 16D10 protein was secreted from the stylet (Huang et al., 2006a). *16D10* was shown to be conserved in all four major species of root-knot nematode, but absent from 2 other nematode species, *Heterodera glycines* and *Caenorhabditis elegans*, using a Southern blot. It was also not found in the plants *Nicotiana tabacum* or *Arabidopsis thaliana* (Huang et al., 2006a). The *16D10* sequence was also confirmed to be unique to RKN through BLAST searches of available gene databases. When the *16D10* gene was overexpressed in *Arabidopsis*, the transgenic plants had significantly increased root lengths due to increased root cell division (Huang et al., 2006a). A yeast-two-hybrid assay (Huang et al., 2006a) showed that 16D10 specifically interacted with the SAW domain of plant SCARECROW-like transcription factors (Di Laurenzio et al., 1996), leading to the conclusion that the secreted 16D10 effector may modulate the activity of SCARECROW-like transcription factors during root cell differentiation to promote feeding cells.

To test the importance of 16D10 in giant-cell formation, Huang et al. (2006b) used RNA interference (RNAi) to silence *16D10* gene expression. In initial assays (Huang et al., 2006b), root-knot nematode second-stage juveniles were induced to ingest *16D10* double-stranded RNA (dsRNA) from a soaking solution *in vitro*, resulting in strong inhibition of the *16D10* transcript. Next Huang et al. (2006b) fed the root-knot nematodes the 16D10 dsRNA using *Arabidopsis thaliana*, a host plant, to deliver the dsRNA. Floral dip with *Agrobacterium tumefaciens* (Clough and Bent, 1998) was used to stably transform *Arabidopsis* plants with two different 16D10 dsRNA constructs. These RNAi constructs

were driven by the CaMV35S promoter and contained either 42bp (RNAi-1) or 271 bp (RNAi-2) of *16D10* sense sequence, followed by the PDK intron, then the corresponding antisense *16D10* sequence, and were cloned into the pHANNIBAL vector (Wesley et al., 2001) with a kanamycin resistance gene as a selective marker (Huang et al., 2006b). Constitutive expression of 16D10 dsRNA in roots, shoots, and leaves of each transformed *Arabidopsis* line and processing to corresponding small-interfering RNA (siRNA) were confirmed by Southern blot analyses (Huang et al., 2006b). Root-knot nematode infection assays of the pHANNIBAL:: 16D10RNAi transformed *Arabidopsis* plants demonstrated significantly fewer galls (63-90% reduction) and eggs (69-93% reduction) than *Arabidopsis* plants transformed with an empty vector control (Huang et al., 2006b). Huang et al. (2006b) also reported that similar dramatic reductions in successful root infection rates of 16D10-RNAi *Arabidopsis* were achieved with all four major species of RKN.

As stated previously, root-knot nematodes are capable of parasitizing many crop species, including tobacco. Restrictions in fumigant and non-fumigant nematicide use and a limited number of natural sources of resistance to root-knot nematodes, have prompted the need for alternative means to manage root-knot nematode infection. There is currently resistance to *M. incognita* races 1 and 3 available in flue-cured and burley tobacco via the *Rk* gene, which functions by eliciting a hypersensitive response (Yi et al., 2008). Unfortunately, resistance to *M. incognita* races 2 and 4, as well as any of the other major species of root knot nematode, is not available in tobacco and while resistant burley germplasm containing the *Rk* gene exists, it has not been incorporated into any burley tobacco currently used (Yi et al., 2008). One alternative is the delivery by host plants of

RNAi targeted to nematode genes in order to create resistance in the host. The purpose of the research presented here was to investigate whether the 16D10RNAi constructs created by Huang et al. (2006b) could be used to generate broad-spectrum resistance to root-knot nematodes in cultivated tobacco plants.

## **Materials and Methods**

### RNAi Vectors and Tobacco Transformation

Vectors were obtained from Dr. Richard Hussey at the University of Georgia that contained the pHANNIBAL:16D10RNAi-1 and pHANNIBAL:16D10RNAi-2 constructs used by Huang et al. (2006b), both in the pART27 binary vector (Gleave, 1992). Both RNAi constructs were driven by the constitutive CaMV 35S promoter and both contained the PDK intron (Wesley et al., 2001) as the RNAi hairpin loop (Figure 7A). The 16D10RNAi-1 construct contained a 42 bp sense and antisense segment corresponding to the mature 16D10 peptide coding region (Figure 7B) while the 16D10RNAi-2 construct contained a 271 bp sense and antisense segment that included the 16D10 peptide and the signal peptide coding regions (Figure 7C).

Each vector was transformed into ElectroMAX<sup>TM</sup> *Agrobacterium tumefaciens* LBA4404 (Invitrogen) using electroporation (2.0kV, 200 $\Omega$ , 25 $\mu$ F). Tissue of haploid TN90 (burley) and Hicks (flue-cured) tobacco (*Nicotiana tabacum*) tissue was obtained from Dr. Ramsey Lewis, NCSU Department of Crop Science. Neither of these tobacco cultivars contained the *Rk* gene (Yi et al., 1998). The haploids were produced using the method of Burk et al. (1979). The haploid tobacco was then transformed using the leaf tissue explant



method (Horsch et al., 1985; An et al., 1986). Transformants were selected based on their resistance to kanamycin conferred by the *nptII* gene in the pHANNIBAL vector constructs. To create wild-type negative controls, TN90 and Hicks were put through the transformation protocol without the addition of agrobacteria. These untransformed controls were termed “wild-type” and were otherwise treated exactly as the transformed lines.

### Production of Doubled Haploid Lines

Doubled haploids were produced using the midvein tissue culture method of Kasperbauer and Collins (1972). Doubled haploids were then selected based on phenotypic differences: doubled haploid plants have darker, more pubescent leaves and produce seed pods after self-pollination. After self-pollination, seeds were collected from each doubled haploid plant.

### PCR of Tobacco Genomic DNA and RT-PCR of the PDK Intron

PCR analysis was used to confirm the insertion of the 16D10RNAi constructs by amplifying the 35S promoter and sense region of the construct (Begin35S-F: 5'-AGCTCTCCCATATCGACCTGCA -3', BeginPDK-R: 5'-CTTCTTCGTCTTACACATCACTTGTC-3'), as well as the intron, the antisense region and the OCS terminator (EndPDK-F: 5'-ACAGTTGGGAAATTGGGTTCGA-3', midOCS-R:5'-TTA TTA GTT CGC CGC TCG GTG TGT-3') from genomic DNA isolated from the doubled haploid tobacco lines (Figure 8A). The copy number of the transgene insertion was not determined for any of the lines produced.

Since the *16D10* sense and antisense segments of the RNAi constructs should base pair and form dsRNA, those segments should not be available for the production of cDNA and subsequent PCR (Figure 8B). For this reason the best way to check for the expression of the construct using RT-PCR was to amplify the PDK intron in pHANNIBAL (Wesley et al., 2001), which is spliced out of the RNA during the process of dsRNA production in the nucleus and remains single-stranded (Figure 8B). For reverse-transcription PCR (RT-PCR) RNA was extracted from 100mg of root tissue from one plant from each tobacco line using the Qiagen RNAeasy Plant kit and cDNA was created using Super Script® II Reverse Transcriptase (Invitrogen) and the PDK For Primer (5'-GACAAGTGATGTGTAAGACGAAGAAG-3'). The PDK intron (Figure 8B) was then PCR-amplified from the cDNA using the PDK For and PDK Rev (5'-TCGAACCCAATTTCCCAACTGT-3') primers to confirm expression of the 16D10-RNAi construct in each tobacco line (Figure 8B). As a negative control, RNA from all lines was advanced through the same protocol without the reverse transcriptase to account for potential DNA template contamination of the 16D10-RNAi construct in samples.

### Nematode Culture

Cultures of *Meloidogyne incognita* race 4, *Meloidogyne arenaria* race 2, *Meloidogyne javanica*, and *Meloidogyne hapla* were grown on roots of tomato (*Solanum lycopersicon* cv. Rutgers) plants under normal greenhouse conditions. Eggs of each root-knot nematode species used for infection assays were extracted from roots using 0.05% sodium hypochlorite

as previously described by Hussey and Barker (1973) and were immediately used for inoculation.

### *M. arenaria* Infection Assays

Seeds of doubled haploid tobacco plants were germinated and grown in soil in a 16hr day-length lighted growth room at 25°C for 8 weeks. The plants were then transferred to coarse sand with approximately 10 grams of Osmocote® (Scotts) fertilizer in 6-inch clay pots and grown for an additional 2 weeks in a greenhouse. Tests were performed at various times throughout the year so greenhouse conditions such as day length and temperature varied, although the temperature was maintained at a temperature of at least 70°C. The 10 most uniform plants from each of 4 lines, as well as 10 control plants (for a total of 50 plants per assay), were selected and were randomized in a completely random design prior to inoculation. Plants were then inoculated with 10,000 *M. arenaria* eggs diluted in 1-2 ml of water injected into the sand at the base of each plant. *Meloidogyne arenaria* was chosen for assays because no resistance to this RKN species exists in cultivated tobacco. Plants were grown in the greenhouse for 2 months with flood watering daily by soaking in one inch of water for 15 minutes using a flood bench in order to reduce nematode loss previously seen from watering. After the completion of the assay, the total fresh weight of the roots was measured and a 0.5 gram sample of root tissue from each plant was immediately frozen in liquid nitrogen for subsequent RNA extraction. Eggs were extracted from the rest of the root system following the egg extraction protocol using 0.05% sodium hypochlorite (Hussey and Barker, 1973). Egg counts for the total root system were obtained by counting three dilutions

from each total egg extraction and averaging the results. Eggs per gram of root means were obtained based on the fresh weight and the total root system egg counts. Statistical differences were determined using an unpaired t-test with an alpha level of 0.05 with Microsoft Excel, comparing each line to the untransformed control plants.

The *M. arenaria* infection assay was repeated once, exactly as above, except that 0.5g of root tissue was collected from the first two wild-type plants (used as negative controls) and the first four transgenic plants of each line one week prior to the start of the assay. As before, the assay was completed after 8 weeks and root weight and egg counts were taken. The root tissue collected both before and after nematode infection was immediately frozen in liquid nitrogen for subsequent RNA extraction to analyze (below) the 16D10 siRNA levels generated in the transgenic tobacco plants.

#### Infection Assays with Other *Meloidogyne* Species

As before, seeds of doubled haploid tobacco plants were germinated and grown in soil in a lighted growth room at 25°C for approximately 8 weeks, then transferred to sand with 10 grams of Osmocote® (Scotts) fertilizer in 6 inch pots and grown for an additional 2 weeks. The 20 most uniform plants from the TN90 I-8 tobacco line, as well as 20 control plants of untransformed TN90 (for a total of 40 plants per assay), were selected and were inoculated with 10,000 *Meloidogyne* eggs. Three nematode infection test replicates were repeated for each of three of the major species of root-knot nematode (*M. arenaria*, *M. incognita*, and *M. javanica*). Plants were grown as before in the greenhouse with flood watering for 2 months. After the completion of the assay the wet weight of the roots was

measured and eggs were extracted from the rest of the root system (Hussey and Barker, 1973). Egg counts were obtained as described previously. Statistical differences between lines within a test replicate were determined using an unpaired t-test with an alpha level of 0.05 with Microsoft Excel, comparing TN90 I-8 to the wildtype control plants. Additional statistics to determine whether there was a test replicate effect and to determine if there was a line effect (TN90 I-8 versus wildtype) across all 3 test replicates were performed using a two factor (line and test) anova.

### siRNA Expression Analysis

Sequencing of *16D10* small interfering RNA (siRNA) expression in each line was conducted as previously described (Hamamouch et al., 2012) to correlate its expression with the level of RKN infection observed in each tobacco line. For siRNA sequencing, RNA was extracted from root tissue from four plants from each line of the repeat of the TN90 16D10-I line test (see *M. arenaria* Infection Assays above) using the Qiagen RNAeasy Plant kit on the day of collection for the pre-infection samples (one week prior to infection).

Total RNA was submitted to the NCSU Genome Sequencing Lab (GSL) for Ion Proton Sequencing (LifeTechnologies) which has been shown to be effective for RNA sequencing (Toung et al., 2011). Total RNA libraries were created using the Ion Total RNA-Seq Kit (LifeTechnologies). Bioinformatics and statistical analyses of the raw siRNA data were provided by Elizabeth Scholl in the Bioinformatics Research Center at North Carolina State University. Sequences obtained from each RNA sample were trimmed for potential adapter contamination and filtered for reads smaller than 15 bases, and then a small RNA

(smRNA) sample was created by counting the occurrences of tags extracted from the reads. These smRNA were then compared to a subset of miRBase as well as the two sequences from the 16D10RNAi construct (sense and anti-sense). Annotation was run asking for strand-specific information to differentiate the sense-strand 16D10 from the anti-sense 16D10 construct. The constructs sequence was given a higher priority in the search than the smRNA from miRBase. The miRBase data used for the searches came from the following organisms: *Arabidopsis*, *Medicago*, *Nicotiana*, *Solanum*, *Ascaris*, *Brugia* and *Caenorhabditis*. These were included as a control to confirm detection of known smRNA. Any smRNA that was close to identical in more than one species was annotated for each of those species. For statistical analysis, differential expression of smRNA between replicates for each of the five samples and differential expression of smRNA between samples was performed. All were analyzed using pairwise comparisons and for each experimental set, calculated expression values from the annotations were normalized using a quantile approach (Bolstad et al., 2003). The full analysis was also run with scaling normalization, with little change to the results. Normalized counts were then used for Baggerly's Test (beta-binomial), which compares the proportions of the counts between the samples in a pairwise manner (Baggerly et al., 2003). For the comparison between replicates within a line, p-values were corrected using a Bonferroni correction method for multiple tests (Dunn, 1961). For comparison between TN90 lines, p-values were also Bonferroni corrected as well as FDR corrected (Benjamini, 2010).

## **Results**

### Tobacco Transformation and Tobacco Doubled Haploid Production

From the initial screening for kanamycin resistance, 35 haploid lines of TN90 transformed with the 16D10-I construct, 35 haploid lines of TN90 transformed with the 16D10-II construct, 31 haploid lines of Hicks transformed with the 16D10-I construct, and 27 haploid lines of Hicks transformed with the 16D10-II construct were obtained. Tobacco lines that showed mutant phenotypes, most likely due to positional effects of tDNA insertion, were discarded. From the remaining lines, doubled haploids were produced and seeds were collected from 14 lines of TN90 transformed with the 16D10-I construct, 8 lines of TN90 transformed with the 16D10-II construct, 12 lines of Hicks transformed with the 16D10-I construct, and 9 lines of Hicks transformed with the 16D10-II construct. The reduction in lines was mostly due to an inability to produce double haploids from some of the lines due to death of the plants prior to successful double haploid production.

### PCR of Tobacco Genomic DNA and RT-PCR of the PDK Intron

Genomic DNA was extracted from all of the doubled haploid lines and was analyzed by PCR (Figure 8A) for the presence of the full 16D10RNAi insertion. Of the 14 TN90 16D10-I lines from which doubled haploids were obtained, 13 lines were shown to contain the full construct via genomic PCR (Figures 9A & 9C). Of the 8 TN90 16D10-II lines from which doubled haploids were obtained, 7 lines were shown to contain the full construct via genomic PCR (Figure 9B & 9D). In Figure 9B the bands are faint for lines II-12, II-13, and II-14, and no band is present for TN90 II-4, but a later PCR confirmed the presence of the

first half of the construct. Of the 12 lines of Hicks 16D10-I from which doubled haploids were obtained, 10 lines were shown to contain the full construct via genomic PCR (Figure 10A & 10C) and of the 9 lines of Hicks 16D10-II from which doubled haploids were obtained, 6 lines were shown to contain the full construct via genomic PCR (Figure 10B & 10D). Seeds from all lines that were not shown to contain the full-length construct were set aside and were not used for any further experiments.

To examine the expression of 16D10RNAi constructs in transformed tobacco lines, RNA was extracted from all of the remaining lines and cDNA was amplified using the PDK For primer (Figure 8B) since the usual oligo dT primer requires a poly-A tail that is not present in the 16D10-RNAi constructs. The PDK intron was then PCR amplified from the cDNA using the primers PDK For and PDK Rev (Figure 8B). Expression of the PDK intron was successfully amplified from 16D10RNAi constructs in all of the lines that contained the full-length construct, both in TN90 (Figure 11A & 11B) and Hicks (Figure 12A & 12B). As a negative control, RNA from all lines was put through the cDNA protocol except no reverse transcriptase was added, so no cDNA was produced. PCR amplification of the PDK intron minus reverse transcriptase is underway to confirm that the bands seen in Figure 11 and Figure 12 are absent from the negative controls, showing that they are from cDNA and not from genomic DNA contamination of the RNA samples.

#### *M. arenaria* Multi-line Nematode Infection Assays

Two-month nematode infection assays were carried out to test the nematode resistance of the transgenic doubled haploid tobacco lines using 10,000 eggs of *M. arenaria*



per plant. These assays tested 4 lines each from TN90 16D10-I, Hicks 16D10-I, and Hicks 16D10-II. A test of TN90 16D10-II was also attempted twice but extremely low infection rates in the wild-type controls and a white fly and fungal epidemic that killed most of the plants prior to completion of the assay caused the data from these tests to not be useable.

Four lines of TN90 transformed with the 16D10RNAi-I construct were tested along with untransformed TN90 (wild-type) as a control. These lines were TN90 I-2, I-6, I-8, and I-18. Fresh root weights from each line were compared to wild-type and no significant difference ( $\alpha=0.05$ ) was found for any of the lines (Table 1A, Figure 13C). The number of eggs per plant at the end of the assay was counted (Figure 13A), and significance was determined by an unpaired t-test with  $\alpha=0.05$ . The results of this test are shown in Table 1A and Figure 13. Three of the lines, TN90 I-2, I-8, and I-18, had an average eggs per plant significantly lower than wild-type ( $\alpha=0.05$ ), however the TN90 I-6 line was not significantly different from wildtype (p-value of 0.26). The TN90 I-8 line had the greatest percent egg reduction as compared to wildtype with a reduction of 62.9% and a significant p-value of  $3.8 \times 10^{-5}$ . Using the root fresh weights of each plant, the number of eggs/g of root was calculated (Table 1A, Figure 13B). The eggs/g of root for the same three lines (TN90 I-2, I-8, and I-18) were found to be significantly lower than wild-type ( $\alpha=0.05$ ). The TN90 I-6 line was again not significantly lower (p-value of 0.35) than wild-type. The TN90 I-8 line again had the greatest percent reduction as compared to wildtype, 56.2%.

As with the TN90 16D10RNAi-I lines, 10 plants from each of 4 lines of Hicks 16D10RNAi-I along with 10 Hicks wild-type control plants were inoculated with 10,000 eggs of *M. arenaria* per pot. After 2 months, the average number of eggs/plant was

determined (Table 1B, Figure 14A), the roots were weighed (Table 1B, Figure 14C) and the average eggs/g of root was calculated (Table 1B, Figure 14B). As with the TN90 16D10RNAi-I infection assay, significant differences were determined based on an unpaired t-test with  $\alpha=0.05$ . Again the root weights were compared and none of the lines were found to be significantly different from wild-type (Table 1B, Figure 14C). None of the four lines tested were significantly different from wildtype for the average eggs per plant, however 2 of the lines, Hicks I-4 and Hicks I-14, each had an outlier plant that was significantly higher than the other plants in the line, and when the outliers were excluded the average eggs per plant were significantly lower than wildtype (Table 1B). Also once the root system size was taken into account the same two lines, Hicks I-4 and Hicks I-14, were significantly lower than wildtype whether or not the outlier was excluded (Table 1B, Figure 14B).

For the Hicks 16D10RNAi-II lines, again 10 plants from each of 4 lines, along with 10 Hicks wild-type control plants, were inoculated with 10,000 eggs of *M. arenaria* per pot. After 2 months, the average number of eggs/plant was again determined (Table 1C, Figure 15A), the roots were weighed (Figure 15C) and the average eggs/g of root was calculated (Figure 15B). As with the previous infection assays, significant differences were determined based on an unpaired t-test with  $\alpha=0.05$ . Hicks II-12 and II-20 were the only lines tested to show significantly different root system weights as compared to wild-type (Table 1C, Figure 15C), and both had significantly higher root weights than wildtype with 28.3% increase in root system size for Hicks II-12 and a 30.8% increase for Hicks II-20. Of the 4 lines tested, only Hicks II-20 was significantly different than wildtype whether or not the root system size was taken into account (Table 1C, Figure 15).

In order to determine the siRNA levels in the resistant 16D10RNAi plants and attempt to correlate the siRNA levels to the resistance, RNA needed to be extracted from root tissue from which an infection level could be determined. Since 3 of the four TN90 16D10-I lines were observed to be significantly different from wild-type, this test was selected to be repeated in order to extract siRNA from plants both 1 week before and during (week 6) the infection assay. The infection assay was performed and analyzed exactly as before. Unfortunately, the infection level of the wild-type control plants was much lower than in previous tests with an average of 36,727 eggs/plant and 594 eggs/g of root (Table 2) as compared to the previous test average of 67,533 eggs/plant and 777 eggs/g of root (Table 1). The low infection rates in this test were most likely because the test was performed in the winter, and even in the greenhouse the infection levels tend to be lower in the winter. This made it difficult to see significant differences even when the infection levels were more than 30% lower than wild-type (Table 2, Figure 16). The TN90 I-8 average eggs/plant was not significantly different (p-value of 0.13) even with 36.6% less eggs than wild-type, but this line also had an outlier with 87,333 eggs/plant, and when the outlier was excluded, this line was significantly different than wildtype. Also, adjusted for the root system size the eggs/g of root (Figure 16B) were significantly different (p-value of 0.030) than wild-type whether or not the outlier was included.

### siRNA Sequencing

*16D10* siRNA was not expressed in either of the two wild-type TN90 tobacco samples used as negative controls (Table 3). siRNA from 16D10RNAi TN90 plants was also

not expressed in sample I-2 #2, and only the anti-sense was found in sample I-2 #3 (Table 3). All other transgenic TN90 tobacco samples expressed siRNA derived from the 16D10RNAi construct (Table 3). The comparisons between the TN90 lines included all the replicates of each sample and normalization was completed across all data. A boxplot of the distribution of the normalized reads indicates that normalization was effective all replicates of all samples (see supplemental data). Significant differences in *16D10* siRNA expression between lines were found using Baggerley's test and multiple testing correction was done with both Bonferroni methods and FDR methods, and significance was based on the adjusted p-values. The significant differences found are highlighted in red in Table 3B. The TN90 line I-2 was not significantly different from wild-type for the positive or the negative strands while the TN90 I-6 was significantly different from wild-type for both positive and negative strands. TN90 I-8 was significantly different was significantly different from wild-type for the positive strand only. Line TN90 I-18 was significantly different from wild-type for both positive and negative strands.

It was determined that the I-6 #4 and I-8 #2 replicates were outliers and the statistical analysis was repeated excluding these replicates (Table 3B). Without the outlier, expression of 16D10 siRNA in TN90 line I-6 was still significantly different from wild-type for both positive and negative strands. With the exclusion of the outlier, TN90 line I-8 was shown to still be significantly different from wild-type for the positive strand, and removal of the outlier caused it to be significantly different from wild-type for the negative strand as well.

Comparisons between replicates within a line were also made, and *16D10* siRNA was found to be differentially expressed between the replicates within a line. No significant

differences in expression of *16D10* siRNA were found between the I-2 replicates. I-6 #4 was found to be significantly different in expression of *16D10* siRNA from the other 3 I-6 replicates, indicating it was an outlier. The sense strand counts for I-6 #3 were also found to be significantly different from the other I-6 replicates, but the antisense counts were not significantly different. I-8 # 2 was found to be significantly different in expression of *16D10* siRNA from all the other I-8 replicates for the antisense strand and was found to be significantly different from I-8 #2 for the sense strand as well. This data along indicated that it was an outlier. I-8 #1 antisense strand counts were also found to be significantly different from all the other replicates, but the sense strand counts were not significantly different. I-18 #1 and I-18 #2 were found to be significantly different in expression of *16D10* siRNA from I-18 #3 and I-18 #4 for the sense strand counts, but were not significantly different for the antisense strands.

#### TN90 I-8 Nematode Infection Assays with Multiple *Meloidogyne* species

In order to test the resistance of the 16D10RNAi transformed tobacco to the major species of root-knot nematode, one of the most resistant lines, TN90 I-8, was selected. As before 10,000 nematode eggs were used to inoculate each pot and tests were run for 2 months, however the replicate number was increased from 10 plants per line to 20 plants of TN90 I-8 and 20 plants of wild-type TN90 as controls. As with the previous infection assays, all p-values were determined using an unpaired t-test, which compared the TN90 I-8 plants to the wild-type control plants. Significance was determined by a p-value of 0.05 or

less. Since in the eggs/gram of root and eggs/plant showed similar results, only eggs/g of root data will be presented.

First *M. arenaria* was again used for inoculation to confirm the previous results, and 3 repeats of the test were conducted (Table 4A, Figure 17). For all 3 repeats, TN90 I-8 was found to have significantly lower eggs/g of root than wildtype, with a reduction in egg count ranging from 48.8-60.2%. In order to compare the tests to each other, the data was normalized to the wildtype control, setting wildtype a value of 1.0. A two factor ANOVA test was then performed on the normalized data from the 3 tests together and the difference between the lines (wildtype and TN90 I-8) was significant, while no test effect (p-value of 0.860) was observed (Table 4A).

The second *Meloidogyne* species tested was *M. incognita*, specifically race 4. As with *M. arenaria*, the infection levels of the TN90 I-8 plants in the first 2 tests were significantly lower than wild-type, with a reduction of 42.0 and 52.3% (Table 4B, Figure 18). However the results from the third infection assay did not show a significant difference (p-value of 0.48), most likely because the infection level was extremely low for *M. incognita*, with the wild-type average eggs/g of root only 698 (Table 4B, Figure 18). Most likely this low infection level was again due to performing the test during the winter months, although again the test was conducted in a heated greenhouse. Again the data was normalized and a two factor ANOVA was performed, showing that for the 3 repeats together there was a significant difference between the two lines but there was not a significant test effect, despite the low infection level of the third repeat (Figure 18C).

The next species tested was *M. javanica*, and again 3 repeats were. The first infection assay showed similar resistance as was seen with *M. arenaria* and *M. incognita* (Table 4C, Figure 19) with significantly lower eggs/gram root in the TN90 I-8 plants than the wild-type plants. The results of the second and third infection assays were very different. For the second infection assay (Figure 19B), the average eggs/g of root for wild-type was 9594, more than 4 times the infection level of the first test, and much higher than was seen in any other infection assay, even though the starting inoculum (10,000 eggs) was not altered. Also the eggs/g of root for TN90 I-8 was significantly higher (p-value of  $2.3 \times 10^{-5}$ ) than wild-type, with an average of 19446 eggs/g of root, a 102.7% increase. During this test one of the wild-type plants died and several of the wild-type and the TN90 I-8 plants were close to death at the end of the assay, due to a massive white fly infestation that was followed by an unknown fungal infection (most likely caused by *Pythium spp.* from the symptoms). The greenhouse benches were thoroughly bleached and sprayed with insecticides before the third test, however the white fly epidemic and fungal infestation was repeated, although this time all the plants survived until the end of the assay. Again the infection levels were much higher than usual in the wild-type plants (6205 eggs/g of root) and again significantly higher (p-value of 0.0002) for TN90 I-8 with an average of 11,019 eggs/g of root, a 77.6% increase (Figure 19C). The two factor ANOVA of the normalized data from the three tests (Figure 20) showed a significant difference between the lines, although in this case the TN90 I-8 line had significantly higher eggs/g of root than wildtype. However, for this set of repeats there was a significant test effect (p-value of  $7.02 \times 10^{-8}$ ), indicating that the test repeats were significantly different from one another.

## Discussion

The resistance in both flue-cured and burley tobacco to multiple species of *Meloidogyne* observed in this study makes the use of 16D10RNAi as a root-knot nematode control very promising. The only resistance currently commercially available in flue-cured and burley tobacco lines for *M. incognita* in the United States is the *Rk* gene, which confers resistance only to races 1 and 3 of *M. incognita* (Yi et al., 1998). While resistance to race 1 of *M. arenaria* is available in flue-cured tobacco, this resistance is incomplete when compared to the resistance conferred by the *Rk* gene to races 1 and 3 of *M. incognita* (Ng'ambi et al., 1999a). A study of tobacco germplasm by Ng'ambi et al. (1999b) found limited resistance to *M. arenaria* race 2, *M. incognita* races 2 and 4, and *M. javanica*, but no resistance to *M. hapla* was found. While the 16D10RNAi tobacco produced in this study was not tested against *M. hapla*, the 16D10RNAi Arabidopsis created by Huang et al. (2006b) was found to be resistant to *M. hapla*, indicating the 16D10RNAi tobacco may also be resistant to *M. hapla*. Also the 16D10RNAi tobacco was found to be resistant to *M. incognita* race 4, for which only limited resistance is available in tobacco germplasm (Ng'ambi et al., 1999b). To further improve resistance, the 16D10RNAi constructs could easily be transformed into tobacco germplasm that already contains the *Rk* resistance gene, which could improve already elite germplasm.

In this study thirty six lines of tobacco were successfully transformed with the full-length 16D10RNAi constructs created by Huang et al. (2006b), twenty lines of the burley tobacco TN90 and 16 lines of flue-cured tobacco Hicks. Twelve of these lines were tested for *Meloidogyne arenaria* resistance, and three lines of TN90 16D10-I, 2 lines of Hicks



16D10-I, and 1 line of Hicks 16D10-II were shown to have significantly lower nematode reproduction than the untransformed wild-type controls.

Only two lines of Hicks 16D10-II tested showed a significantly different root system size compared to the wild-type controls, and both were significantly larger than the wildtype controls. One of these lines, Hicks II-20, is of particular interest because it was also the only Hicks 16D10-II line found to be significantly different from wildtype (p-value of less than 0.01) and had a decrease in infection of more than 70% as compared to wild-type, whether or not the root system size was taken into account. It is also possible that the increase in root system size is the result of a positional effect of the insertion, since this increase in root system size was only seen in 2 lines of transformed tobacco and was not seen in any of the 16D10RNAi *Arabidopsis* transformed by Huang et al. (2006b). The reason for the root system increase still needs further study since having a larger root system with a lower infection rate makes this line of particular interest, as a larger root system might be indicative of a greater yield potential.

While the levels of resistance varied from line to line, the best resistance shown was a reduction of 73.2% in eggs/g of root in the Hicks II-20 line (Figure 15C). While a 73.2 % reduction is significant and agronomically useful, overall the reduction in eggs/g of root seen was as not great as was seen in the 16D10RNAi *Arabidopsis* plants produced by Huang et al. (2006b), who found an eggs/g of root reduction of 69-93 % as compared to the wildtype controls. Most likely this is due to the increase in complexity of the plant species being tested, as tobacco is a much more complex plant than *Arabidopsis thaliana*. A recent study by Yang et al. (2013) testing the efficacy of the Huang et al. (2006b) 16D10RNAi constructs

in grapevine hairy roots produced lines with resistance as great as 97%, however only 4 of the 21 lines tested showed a significant decrease in eggs/g of root when compared to an empty vector control. This indicates that the challenges to obtaining stable resistance in transgenic grape may be similar to those seen in this study using transgenic tobacco. Many researchers have had difficulties getting stable transgene expression of RNAi constructs, and unstable expression has been found in tobacco with RNAi targeting the tomato spotted wilt virus (TSWV) (Liu et al., 2003). Also, multiple gene copies can lead to unstable transgene expression (Butaye et al., 2005), and the copy number is unknown for all of the 16D10RNAi tobacco lines. Unstable expression due to transcriptional silencing could account for the decreased resistance seen in the 16D10RNAi tobacco as compared to the 16D10RNAi Arabidopsis, although the gene copy number of the 16D10RNAi Arabidopsis is also unknown (Huang et al., 2006b). One way to prevent transcriptional silencing is with the use of matrix attachment regions (MARS), and the use of a tobacco Rb7 MAR was found to improve the stability of the TSWV RNAi construct created by Liu et al. (2003) in tobacco (Levin et al., 2005). The possibility that unstable expression may be the cause of the lower resistance in tobacco is supported by the high variation seen both between lines of tobacco and also the high variation seen within the 16D10RNAi transgenic tobacco lines. The two lines of Hicks 16D10-I that were found to be significantly different from wild-type (I-4 and I-14) both had outlier plants that had significantly higher eggs/g of root than the other plants within the line (Table 1B). These outliers were both more than 3 times higher than the next highest replicate plant within the line. While nematode infection assays often show great deal of variability, and variability was seen in the wildtype controls, the transgenic plants in

both the I-4 and I-14 lines had a relatively consistent level of resistance with the exception of the two outliers. This makes it unlikely that the increase in eggs/g of root seen in the 2 outliers was due to typical variation seen in nematode infection assays. This indicates that the differences in resistance may be due to differences in the expression levels of the RNAi constructs. Outliers like these can make it difficult to see significant differences between the control and the transformed line being tested. Since variability is often an issue in infection assays this makes it important to have multiple plant replicates in order to increase the likelihood of seeing a statistically significant difference.

To determine if different lines or if different plants within a line had different siRNA expression levels, the test of four TN90 16D10RNAi lines was repeated, in an attempt to correlate the siRNA levels to the resistance levels. This test was selected because three of the four TN90 16D10-I lines were seen to be significantly different from wild-type, however, in the test repeat only one of the lines, I-8, was found to be significantly different from wild-type. This was most likely because the infection levels of the wild-type control plants were much lower than in previous tests (average of 36,727 eggs/plant and 594 eggs/g of root as compared to an average of 67,533 eggs/plant and 777 eggs/g of root in the previous TN90 16D10-I test). This test was performed in the winter, and even in the greenhouse the root-knot nematode infection levels tend to be lower in the winter. This made it difficult to see significant differences even when the infection levels were more than 30% lower than wild-type. All four lines had at least 25% lower infection rates as compared to the controls, however only I-8 was significantly different than wild-type when adjusted for the root system size.

While the purpose of repeating this test was to determine whether there was a correlation between siRNA levels and resistance, little can be statistically determined so far from the results due to the low infection rate. What can be determined is that all 4 lines tested do express 16D10RNAi while wild-type does not. However, only 3 of the lines were statistically different than wild-type. The I-8 line was significantly different than wild-type for both the siRNA levels and the infection level, however it was not significantly different from the other lines. It is difficult to determine the quantity of siRNA required based on this study. It appears that as low as 40 counts each of sense and antisense 16D10 siRNA out of approximately 1,000,000 reads is sufficient to confer partial resistance in the case of line I-8 plants 3 and 4. However, counts of line I-6 plants were much higher than the I-8 plants (with sense and antisense counts greater than 3,000 in the case of I-6 plant 3) and seemed to be less resistant than the I-8 plants. This may indicate that too high a concentration of 16D10 siRNA may have a negative impact on silencing. The line with the lowest siRNA expression, I-2, did have the greatest infection levels, although they were not significantly higher than any of the other lines. What is also of note is that the only transgenic plant to not have any 16D10RNAi expression, I-2 #2, also had the highest infection level out of all the I-2 lines tested (1070 eggs/g of root), a level higher than even the wild-type average (594 eggs/g of root). A similar example is the I-6 outlier (I-6 #4), which had significantly lower siRNA levels than the other three replicates within the line, and also had a higher egg count than the other replicates tested for siRNA. While the differences in nematode infection levels for both of these lines were not significant, this still indicates that further testing should be done to see if a correlation can be made, and if an ideal range of siRNA quantity can be

determined. The Yang et al. (2013) study of the use of 16D10RNAi in transgenic grape hairy roots generally found higher counts than were seen in this study, with siRNA counts higher than 15,000 for both the sense and antisense 16D10 siRNA strands in four lines out of the six tested. However, Yang et al. (2013) did not see a strong correlation between siRNA counts and infection level, as only two of the four lines with significant siRNA counts also had significantly fewer eggs per gram of root than the empty vector controls. A study by Hamamouch et al. (2012) looking at host derived RNAi targeted to the *30C02* parasitism gene in *Heterodera schachtii* identified relatively moderate expression levels of primarily of 21nt siRNA in lines but still found significant resistance to *H. schachtii*. Another way to determine if the siRNA is being expressed is to extract nematodes from the root tissue after infection and quantify the 16D10 protein (Huang et al., 2006a) being produced by the nematodes, since the goal of the siRNA is to silence 16D10 transcript expression in the nematode. Also the tissue used for siRNA extraction in this experiment was whole root tissue; in the future it would be interesting to extract siRNA from the feeding sites to confirm that the siRNA is being expressed locally in the feeding sites.

The potential use of the constitutive *Gmubi* promoter (Chiera et al. 2007) or the nematode-inducible *NtCel7* promoter (Wang et al., 2007) to drive *16D10* dsRNA/siRNA expression in nematode feeding sites is being explored as described in the construct modification chapter. The *NtCel7* promoter has already been successfully used by Patel et al. (2010) to silence the *Hs4F01* gene in *Heterodera schachtii* by using the *Ntcel7* promoter to drive a pHANNIBAL hairpin dsRNA construct targeting the *Hs4F01* gene. Since proper splicing of the intron is also crucial for dsRNA production (Wesley et al., 2001) and

subsequent siRNA production, another modification that can be made to the RNAi construct is changing the intron spacer with one that is more likely to be spliced. Splice sites for intron spacers are determined by both the sequence of the intron and the sequence of the surrounding construct (Hebsgaard et al., 1996). Splice site prediction is available for intron constructs in Arabidopsis via the website NetPlantGene (<http://www.cbs.dtu.dk/services/NetPlantGene/>), produced by Hebsgaard et al. (1996). One possible alternative spacer currently being explored in the construct modification chapter is the GUS spacer, a portion of the GUS gene (Li et al., 2010), which has previously been used as a spacer for other RNAi constructs (Li et al., 2010).

What is clear from the data is that the TN90 I-8 line does express the *16D10* dsRNA and is significantly more resistant than wild-type TN90 to *M. arenaria*. To further confirm this, three repeated tests with a larger number of replicates also all indicated that the TN90 I-8 line is resistant to *M. arenaria*, with a range of 48.8-60.2% less eggs/g of root than the wild-type controls. This line was then tested against two of the other major species of root-knot nematode, *M. incognita* and *M. javanica*. For *M. incognita*, two of the three repeated tests showed similar levels of resistance as were seen in *M. arenaria*, with 42.0 and 52.3% less eggs than the wild-type controls. Most likely this was because the wild-type infection level was very low for *M. incognita* (wild-type average eggs/g of root of 698, as compared to 2,739 and 4,781 eggs/g of root in the previous two tests). This was most likely because the test was performed during the winter months, when *M. incognita* tends to be a bit less aggressive. Despite the low infection by *M. incognita* in the third test it can be statistically determined by two factor ANOVA tests that the TN90 I-8 line has significantly lower

nematode reproduction rates than the wildtype controls for both *M. arenaria* and *M. incognita*. The first test against *M. javanica* showed similar results to the other two species (the TN90 16D10RNAi line was significantly more resistant and had 42.0% fewer eggs/g of root than wild-type). However, the results of the second and third infection assays demonstrated the opposite, an increase in *M. javanica* infection relative to wild-type controls. During the second and third *M. javanica* tests there was a massive white fly infestation, as well as an unknown fungal infection (most likely caused by *Pythium spp.* from the symptoms), and in both cases some plants showed severe pest symptoms by the end of the assay. Perhaps in this case, the fungal and white fly infestations put the plants under enough stress that they became more susceptible to root-knot nematode infection, or perhaps the siRNA is not expressed as highly under stressed conditions. A two factor ANOVA did determine that there was a significant test effect, indicating that these tests should be repeated to determine whether or not the TN90 I-8 line is resistant to *M. javanica*.

Despite some inconsistent results with *M. javanica*, it is clear that expression of the 16D10RNAi constructs created by Huang et al. (2006b) in tobacco results in tobacco with increased resistance to root-knot nematodes. It needs to be further elucidated whether higher siRNA expression levels result in a lower nematode infection rate, and subsequent tests with the modified 16D10RNAi constructs will assess this hypothesis. While the reduction in infection in tobacco was not as high as was seen in Arabidopsis, the greater than 50% reduction in infection of the 16D10RNAi tobacco lines is a significant step towards genetically engineering resistance to root-knot nematodes. Another downstream application for this research is to pyramid several RNAi constructs targeting different nematode genes

together. RNAi against the *8D05* parasitism gene of *M. incognita* expressed in transgenic Arabidopsis has recently been shown to silence *8D05* expression in the nematode and result in reduction of root-knot nematode infection of Arabidopsis roots by 73-90% (Xue et al., 2013). With improved construct design and delivery, the potential utility of host-derived RNAi targeted to nematode parasitism genes shows great potential in cultivated crop species.

## References

- An, G, Watson, BD, and Cheng, CC. 1986. Transformation of tobacco, tomato, potato, and *Arabidopsis thaliana* using a binary Ti vector system. *Plant Physiol.* 81:301-305
- Back, MA, Haydock, PPJ, and Jenkinson, P. 2002. Disease complexes involving plant parasitic nematodes and soil-borne pathogens. *Plant Pathol.* 51:683-697
- Baggerly, K, Deng, L, Morris, J, and Aldaz, C. 2003. Differential expression in SAGE: accounting for normal between-library variation. *Bioinformatics* 19(12):1477-1483
- Benjamini, Y. 2010. Discovering the false discovery rate. *Journal of the Royal Statistical Society: Series B (Statistical Methodology)* 72(4):405–416
- Bird, AF, and Saurer, W. 1967. Changes associated with parasitism in nematodes. II. Histochemical and microspectrophotometric analyses of preparasitic and parasitic larvae of *Meloidogyne javanica*. *J. Parasitol* 53:1262-1269
- Bird, AF. 1968. Changes associated with parasitism in nematodes. IV. Cytochemical studies on the ampulla of the dorsal esophageal gland of *Meloidogyne javanica* and on exudations from the buccal stylet. *J. Parasitol.* 54:879-890
- Bolstad, BM, Irizarry, RA, Astrand, M, and Speed, TP. 2003. A comparison of normalization methods for high density oligonucleotide array data based on variance and bias. *Bioinformatics* 19(2): 185–193
- Burk, LG, Gerstel, DU, and Wernsman, EA. 1979. Maternal haploids of *Nicotiana tabacum* L. from seed. *Science* 206:585-585
- Butaye, K, Cammue, B, Delaure, S, and De Bolle, M. 2005. Approaches to minimize variation of transgene expression in plants. *Mol Breed* 16:79–91
- Chiera, JM, Bouchard, RA, Dorsey, SL, Park, E, Buenrostro-Nava, MT, Ling, PP, and Finer, JJ. 2007. Isolation of two highly active soybean (*Glycine max* (L.) Merr.) promoters and their



characterization using a new automated image collection and analysis system. *Plant Cell Rep.* 26:1501-1509

Chitwood, D.J. 2003. Research on plant-parasitic nematode biology conducted by the United States Department of Agriculture-Agricultural Research Service. *Pest Manage. Sci.* 59:748-753

Davis, EL, Hussey, RS, and Baum, TJ. 2004. Getting to the roots of parasitism by nematodes. *Trends Parasitol.* 20:134-141

Davis, E, Hussey, R, Baum, T, Bakker, J, Schots, A, Rosso, M, and Abad, P. 2000. Nematode parasitism genes. *Annu Rev Phytopathol* 38:365-396

Di Laurenzio L, WysockaDiller J, Malamy JE, Pysh L, Helariutta Y, Freshour G, Hahn MG, Feldmann KA, Benfey PN (1996) The *SCARECROW* gene regulates an asymmetric cell division that is essential for generating the radial organization of the Arabidopsis root. *Cell* 86:423-433

Dunn, O J. 1961. Multiple comparisons among means. *Journal of the American Statistical Association* 56(293):52-64

Edmunds, J.E., and Mai, W.F. 1967. Effect of *Fusarium oxysporum* on movement of *Pratylenchus penetrans* towards alfalfa roots. *Phytopathology* 57:468-471

Gleave, AP. 1992. A versatile binary vector system with a T-DNA organisational structure conducive to efficient integration of cloned DNA into the plant genome. *Plant Molecular Biology* 20:1203-1207

Goellner, M, Wang, X, and Davis, EL. 2001. Endo- $\beta$ -1,4-glucanase expression in compatible plant-nematode interactions. *Plant Cell* 13:2241-2255

Hamamouch, N, Li, C, Hewezi, T, Baum, TJ, Mitchum, MG, Hussey, RS, Vodkin, LO, and Davis, EL. 2012. The interaction of the novel 30C02 cyst nematode effector protein with a plant beta-1,3 endoglucanase may suppress host defense to promote parasitism. *Journal of Experimental Botany* 63:3683-3695

Hasan, A. 1985. Breaking the resistance in chilli to root-knot nematodes by fungal pathogens. *Nematologica* 31:210-217

Hebsgaard, SM, Korning, PG, Tolstrup, N, Engelbrecht, J, Rouze', P, and Brunak, S. 1996. Splice site prediction in *Arabidopsis thaliana* Pre-mRNA by combining local and global sequence information. *Nucleic Acids Res.* 24:3439-3452

- Hernandez-Garcia, CM, Martinelli, AP, Bouchard, RA, and Finer, JJ. 2009. A soybean (*Glycine max*) polyubiquitin promoter gives strong constitutive expression in transgenic soybean. *Plant Cell Rep.* 28:837-849
- Horsch, RB, Fry, JE, Hoffman, NL, Eichholtz, D, Rogers, SG, and Fraley, RT. 1985. A simple and general method for transferring genes into plants. *Science* 227:1229-1231
- Huang, CS. 1985. Formation, anatomy, and physiology of giant cells induced by root-knot nematodes. In: Sasser, JN, and Carter, CC (eds). An advanced treatise on Meloidogyne, vol 1, biology and control. North Carolina State University Graphics, Raleigh, NC pp.155-164
- Huang, GZ, Gao, B, Maier, T, Allen, R, Davis, EL, Baum, TJ, and Hussey, RS. 2003. A profile of putative parasitism genes expressed in the esophageal gland cells of the root-knot nematode *Meloidogyne incognita*. *Mol. Plant-Microbe Interact.* 16:376-381
- Huang, GZ, Dong, R, Allen, R, Davis, EL, Baum, TJ, and Hussey, RS. 2006a. A root-knot nematode secretory peptide functions as a ligand for a plant transcription factor. *Mol. Plant-Microbe Interact* 19:463-470
- Huang, GZ, Allen, R, Davis, EL, Baum, TJ, and Hussey, RS. 2006b. Engineering broad root-knot resistance in transgenic plants by RNAi silencing of a conserved and essential root-knot nematode parasitism gene. *Proc. Natl. Acad. Sci. USA* 103(39):14302-14306
- Hussey, RS. 1985. Host-parasite relationships and associated physiological changes. In: Sasser JN, Carter CC (eds). An advanced treatise on Meloidogyne, vol I, biology and control. North Carolina State University Graphics, Raleigh, NC pp.143-153
- Hussey, RS. 1989. Disease-inducing secretions of plant-parasitic nematodes. *Annu. Rev. Phytopathol.* 27:123-141
- Kasperbauer, MA, and Collins, GB. 1972. Reconstitution of diploids from leaf tissue of anther-derived haploids in tobacco. *Crop Sci.* 12:98-101
- Koenning, SR, Overstreet, C, Noling, JW, Donald, PA, Becker, JO, and Fortnum, BA. 1999. Survey of crop losses in response to phytoparasitic nematodes in the United States for 1994. *Supplement to the J. Nematol.* 31(4S):587-618
- Levin, JS, Thompson, WF, Csinos, AS, Stephenson, MG, and Weissinger, AK. 2005. Matrix attachment regions increase the efficiency and stability of RNA-mediated resistance to tomato spotted wilt virus in transgenic tobacco. *Trans Res* 14:193-206
- Liu, YS, Levin, JS, Murray, JS, Wernsman, EA, and Weissinger, AK. 2003. A multi-generation analysis of the stability of transgenic virus resistance in doubled-haploid tobacco lines. *Mol Breeding* 12: 145-156

- Mayol, PS, and Bergeson, GB. 1970. The role of secondary invaders in *Meloidogyne incognita* infection. *J. Nematol.* 2:80–83
- Ng'ambi, TBS, Rufty, RC, and Barker, KR. 1999a. Genetic analysis of *Meloidogyne arenaria* race 1 resistance in tobacco. *Plant Dis.* 83(9):810-813
- Ng'ambi, TBS, Rufty, RC, Barker, KR, and Melton, TA. 1999b. Identification of sources of resistance to four species of root-knot nematodes in tobacco. *J. Nematol.* 31(3):272-282
- Nordmeyer, D., and Sikora, R.A. 1983. Studies on the interaction between *Heterodera daverti*, *Fusarium avenaceum* and *F. oxysporum* on *Trifolium subterraneum*. *Revue de Nematologie* 6:193–8
- Patel, N, Hamamouch, N, Li, C, Hussey, R, Mitchum, M, Baum, T, Wang, X, and Davis, EL. 2008. Similarity and functional analyses of expressed parasitism genes in *Heterodera schachtii* and *Heterodera glycines*. *J. Nematol.* 40: 299–310
- Sasser, JN. 1980. Root-knot nematodes: a global menace to crop production. *Plant Dis.* 64:36-41
- Sasser, JN, Eisenback, JD, Carter, CC, and Triantaphyllou, AC. 1983. The International *Meloidogyne* project - its goals and accomplishments. *Annu. Rev. Phytopathol.* 21:271–288
- Sundermann, CA, and Hussey, RS. 1988. Ultrastructural cytochemistry of secretory granules of esophageal glands of *Meloidogyne incognita*. *J. Nematol.* 20:141-149
- Toung, JM, Morley, M, Li, M, and Cheung, VG. 2011. RNA-sequence analysis of human B-cells. *Genome Res* 21(6):991–998
- Venter, M. 2007. Synthetic promoters: genetic control through cis engineering. *Trends Plant Sci* 12:118–124
- Wang, X, Allen, R, Ding, X, Goellner, M, Maier, T, de Boer, JM, Baum, TJ, Hussey, RS, and Davis, EL. 2001. Signal peptide selection of cDNA cloned directly from the esophageal gland cells of the soybean cyst nematode, *Heterodera glycines*. *Mol. Plant-Microbe Interact.* 14:536-544
- Wang, XH, Replogle, A, Davis, EL, and Mitchum, MG. 2007. The tobacco Cel7 gene promoter is auxin-responsive and locally induced in nematode feeding sites of heterologous plants. *Molecular Plant Pathology* 8(4):423-436
- Wesley, SV, Helliwell, CA, Smith, NA, Wang, MB, Rouse, DT, Liu, Q, Gooding, PS, Singh, SP, Abbott, D, Stoutjesdijk, PA, Robinson, SP, Gleave, AP, Green, AG, and Waterhouse, PM. 2001. Construct design for efficient, effective and high-throughput gene silencing in plants. *Plant J* 27:581–590

Yadav, B.C., Veluthambi, K., and Subramaniam, K. 2006. Host-generated double stranded RNA induces RNAi in plant-parasitic nematodes and protects the host from infection. *Mol Biochem Parasitol.* 148:219–222

Yang, Y, Jittayasothorn, Y, Chronis, D, Wang, X, Cousins, P, and Zhong, GY. 2013. Molecular Characteristics and Efficacy of 16D10 siRNAs in Inhibiting Root-Knot Nematode Infection in Transgenic Grape Hairy Roots. *PLoS ONE* 8(7):e69463

Yi, HY, Rufty, RC, Wernsman, EA, and Conkling, MC. 1998. Mapping the root-knot nematode resistance gene (*RK*) in tobacco with RAPD markers. *Plant Dis.* 82:1319–1322

**Table 1. *M. arenaria* infection assays testing multiple transformed 16D10RNAi lines.** Average root fresh weights, average total eggs, average eggs/g of root and % reduction in eggs/g of root as compared to wildtype are shown. P-values obtained from unpaired t-tests comparing each line to the wildtype control are also shown and significant p-values ( $\alpha=0.05$ ) are highlighted in green. **A.** Results of TN90 16D10RNAi-I assay infected with *M. arenaria*. **B.** Results of Hicks 16D10RNAi-I assay infected with *M. arenaria*. **C.** Results of Hicks 16D10RNAi-II assay infected with *M. arenaria*.

| <b>A</b> | Line      | Average Root Weight (g) | Root Weight p-value | Average Total Eggs | Total Eggs p-value    | Average Eggs/g of Root | % Reduction | Eggs/g of Root p-value |
|----------|-----------|-------------------------|---------------------|--------------------|-----------------------|------------------------|-------------|------------------------|
|          | Wildtype  | 87                      |                     | 67533              |                       | 777                    |             |                        |
|          | TN90 I-2  | 105                     | 0.146               | 39600              | 0.00123               | 378                    | 51.4 %      | 0.00194                |
|          | TN90 I-6  | 87                      | 0.480               | 61000              | 0.259                 | 698                    | 10.1 %      | 0.354                  |
|          | TN90 I-8  | 74                      | 0.131               | 25067              | 3.77x10 <sup>-5</sup> | 341                    | 56.2%       | 0.00155                |
|          | TN90 I-18 | 108                     | 0.0773              | 48200              | 0.0114                | 447                    | 42.5%       | 0.0143                 |

| <b>B</b> | Line                        | Average Root Weight (g) | Root Weight p-value | Average Total Eggs | Total Eggs p-value | Average Eggs/g of Root | % Reduction | Eggs/g of Root p-value |
|----------|-----------------------------|-------------------------|---------------------|--------------------|--------------------|------------------------|-------------|------------------------|
|          | Wildtype                    | 30                      |                     | 85067              |                    | 2852                   |             |                        |
|          | Hicks I-2                   | 26                      | 0.295               | 72250              | 0.252              | 2758                   | 3.28 %      | 0.216                  |
|          | Hicks I-4                   | 27                      | 0.349               | 56952              | 0.181              | 2097                   | 26.5 %      | 0.0504                 |
|          | Hicks I-4 outlier excluded  | 25                      | 0.262               | 32222              | 0.00353            | 1283                   | 55.0 %      | 0.00949                |
|          | Hicks I-9                   | 31                      | 0.419               | 77917              | 0.394              | 2490                   | 12.7 %      | 0.101                  |
|          | Hicks I-14                  | 32                      | 0.325               | 56889              | 0.111              | 1776                   | 37.7 %      | 0.0364                 |
|          | Hicks I-14 outlier excluded | 31                      | 0.398               | 41166              | 0.00877            | 1322                   | 53.6%       | 0.0130                 |

| <b>C</b> | Line        | Average Root Weight (g) | Root Weight p-value | Average Total Eggs | Total Eggs p-value | Average Eggs/g of Root | % Reduction | Eggs/g of Root p-value |
|----------|-------------|-------------------------|---------------------|--------------------|--------------------|------------------------|-------------|------------------------|
|          | Wildtype    | 39                      |                     | 169037             |                    | 4283                   |             |                        |
|          | Hicks II-4  | 42                      | 0.224               | 206583             | 0.296              | 4922                   | -14.9 %     | 0.471                  |
|          | Hicks II-10 | 36                      | 0.191               | 151400             | 0.378              | 4208                   | 1.74 %      | 0.422                  |
|          | Hicks II-12 | 51                      | 0.014               | 160533             | 0.414              | 3169                   | 26.0 %      | 0.152                  |
|          | Hicks II-20 | 52                      | 0.002               | 59333              | 0.00261            | 1150                   | 73.2 %      | 0.00149                |

**Table 2. *M. arenaria* TN90 16D10RNAi-I infection assay repeat for siRNA sequencing.** Results of the repeated TN90 16D10RNAi-I assay infected with *M. arenaria*. Average root fresh weights, average total eggs, average eggs/g of root and % reduction in eggs/g of root as compared to wildtype are shown. P-values obtained from unpaired t-tests comparing each line to the wildtype control are also shown and significant p-values ( $\alpha=0.05$ ) are highlighted in green.

| Line                      | Average Root Weight (g) | Average Total Eggs | Total eggs p-value | Average Eggs/g of Root | % Reduction | Eggs/g of Root p-value |
|---------------------------|-------------------------|--------------------|--------------------|------------------------|-------------|------------------------|
| Wildtype                  | 59                      | 36727              |                    | 594                    |             |                        |
| TN90 I-2                  | 55                      | 27056              | 0.202              | 495                    | 16.7 %      | 0.253                  |
| TN90 I-6                  | 59                      | 24833              | 0.145              | 422                    | 29.0 %      | 0.160                  |
| TN90 I-8                  | 68                      | 23278              | 0.135              | 342                    | 42.5 %      | 0.0304                 |
| TN90 I-8 outlier excluded | 66                      | 17455              | 0.0430             | 264                    | 55.6%       | 0.0103                 |
| TN90 I-18                 | 65                      | 24533              | 0.175              | 376                    | 36.8 %      | 0.107                  |

**Table 3. Expression of siRNA in roots of TN90 16D10RNAi-I tobacco lines prior to infection with *M. arenaria*.** **A.** siRNA sequencing results showing total reads pre and post trimming, average siRNA length, and total 16D10 siRNA counts for both the sense and antisense. Eggs/g of root data is also shown. The wildtype plant #1 eggs/g of root data is not available due to an extraction error, but the average eggs per gram of root for the wildtype control plants tested was 594 eggs/g of root. The rows highlighted in pink for lines I-6 and I-8 are outliers. **B.** Statistical results of comparison between wild-type and each line. All p-values were determined using Baggerley's test and were Bonferroni corrected and FDR corrected. Significant ( $\alpha=0.05$ ) p-values are highlighted in green and the text of values that changed after outlier exclusion are in red. TN90 line I-2 was not significantly different from wild-type for the positive or the negative strands. TN90 line I-6 was significantly different from wild-type for both positive and negative strands, whether or not the outlier I-6 #4 (highlighted in pink in **A.**) was removed. TN90 line I-8 was significantly different from wild-type for the positive and the negative strands when the outlier I-8 #2 (highlighted in pink in **A.**) was removed, and was significantly different for the positive strand even with the outlier included. Line I-18 was significantly different from wild-type for both positive and negative strands.

| A                        |               |            |           |            |                    |             |                 |                |
|--------------------------|---------------|------------|-----------|------------|--------------------|-------------|-----------------|----------------|
| siRNA Sequencing Results |               |            |           |            |                    |             |                 |                |
| Plant Sample             | Pre-Trim      |            | Post-Trim |            | 16D10 Unique Reads | 16D10 Sense | 16D10 Antisense | Eggs/g of root |
|                          | Total # Reads | Avg Length | # Reads   | Avg Length |                    |             |                 |                |
| W #1                     | 215,247       | 15.3       | 68,496    | 21         | 0                  | 0           | 0               | unkown         |
| W #2                     | 174,826       | 14.9       | 57,638    | 20.8       | 0                  | 0           | 0               | 179            |
| Average                  | 195,037       | 15         | 63,067    | 21         | 0                  | 0           | 0               | 594            |
| I-2 #1                   | 2,900,108     | 20.6       | 1,866,805 | 22.2       | 10                 | 4           | 6               | 72             |
| I-2 #2                   | 4,010,896     | 21         | 2,353,237 | 22.1       | 0                  | 0           | 0               | 1070           |
| I-2 #3                   | 3,864,673     | 22.8       | 2,504,126 | 23         | 2                  | 0           | 1               | 548            |
| I-2 #4                   | 3,739,818     | 22         | 2,361,038 | 22.4       | 6                  | 4           | 2               | 713            |
| Average                  | 3,802,246     | 22         | 2,432,582 | 23         | 5                  | 2           | 2               | 601            |
| I-6 #1                   | 1,545,552     | 21.3       | 931,665   | 22.1       | 977                | 577         | 363             | 303            |
| I-6 #2                   | 3,606,000     | 20.2       | 2,197,704 | 22.2       | 4,826              | 2,466       | 2,140           | 161            |
| I-6 #3                   | 5,373,590     | 27.3       | 3,443,667 | 24.6       | 10,331             | 6,235       | 3,619           | 294            |
| I-6 #4                   | 837,583       | 14.6       | 267,645   | 20.6       | 39                 | 15          | 22              | 562            |
| Average                  | 3,105,587     | 21         | 1,855,656 | 23         | 4,043              | 2,323       | 1,536           | 330            |
| I-8 #1                   | 1,466,496     | 15.4       | 610,394   | 20.8       | 139                | 64          | 63              | 257            |
| I-8 #2                   | 1,245,001     | 15.6       | 506,154   | 21.4       | 695                | 469         | 199             | 136            |
| I-8 #3                   | 1,003,643     | 14.9       | 337,846   | 21         | 74                 | 44          | 30              | 91             |
| I-8 #4                   | 925,526       | 15.8       | 405,279   | 21         | 78                 | 39          | 38              | 185            |
| Average                  | 964,585       | 15         | 371,563   | 21         | 247                | 154         | 83              | 167            |
| I-18 #1                  | 1,038,033     | 15.4       | 400,071   | 21.2       | 107                | 1           | 77              | 130            |
| I-18 #2                  | 532,706       | 14.5       | 157,189   | 20.9       | 76                 | 46          | 30              | 152            |
| I-18 #3                  | 1,054,816     | 15.6       | 445,795   | 21         | 195                | 119         | 68              | 178            |
| I-18 #4                  | 1,021,284     | 15.1       | 368,094   | 20.8       | 99                 | 66          | 33              | 362            |
| Average                  | 1,038,050     | 15         | 406,945   | 21         | 119                | 58          | 52              | 206            |

| B  |                   |                    |              |                             |                             |                  |                             |                             |                |
|--|-------------------|--------------------|--------------|-----------------------------|-----------------------------|------------------|-----------------------------|-----------------------------|----------------|
| siRNA Averages and Statistical Analysis: |                   |                    |              |                             |                             |                  |                             |                             |                |
| Comparison to Wildtype                   |                   |                    |              |                             |                             |                  |                             |                             |                |
| Plant Sample                             | Post Trim # Reads | 16D10 Unique Reads | Sense strand | p-value (outliers included) | p-value (outliers excluded) | Antisense strand | p-value (outliers included) | p-value (outliers excluded) | Eggs/g of root |
| W Average                                | 63,067            | 0                  | 0            |                             |                             | 0                |                             |                             | 594            |
| I-2 Average                              | 2,432,582         | 5                  | 2            | 0.217                       | 0.217                       | 2                | 0.217                       | 0.217                       | 495            |
| I-6 Average                              | 1,855,656         | 4,043              | 2,323        | 4.04 E-04                   | 1.06 E-09                   | 1,536            | 6.70 E-07                   | 0                           | 422            |
| I-8 Average                              | 371,563           | 247                | 154          | 0.084                       | 0                           | 83               | 8.20 E-03                   | 0.026                       | 342            |
| I-18 Average                             | 406,945           | 119                | 58           | 4.44 E-03                   | 4.44 E-03                   | 52               | 0                           | 0                           | 376            |

**Table 4. TN90 I-8 infection assays with multiple *Meloidogyne* spp.** Average eggs/g of root, % reduction in eggs/g of root as compared to wildtype, and eggs/g of root normalized to the wildtype controls are shown. P-values obtained from unpaired t-tests comparing each line to the wildtype control, as well as p-values obtained from a two factor anova test for the three tests combined are also shown and significant p-values ( $\alpha=0.05$ ) are highlighted in green. **A.** Results of 3 replicate tests of TN90 I-8 assay infected with *M. arenaria*. **B.** Results of 3 replicate tests of TN90 I-8 assay infected with *M. incognita*. **C.** Results of 3 replicate tests of TN90 I-8 assay infected with *M. javanica*.

| <b>A. <i>M. arenaria</i> with TN90 I-8</b> |          |                        |             |                         |                        |                         |                       |
|--|----------|------------------------|-------------|-------------------------|------------------------|-------------------------|-----------------------|
| Test                                       | Line     | Average Eggs/g of Root | % Reduction | t-test p-value          | Normalized Eggs/g Root | Between lines p-value   | Between tests p-value |
| Test 1                                     | Wildtype | 523                    |             |                         | 1                      | 9.30 x 10 <sup>-6</sup> | 0.860                 |
|  | TN90 I-8 | 278                    | 48.8 %      | 0.0169                  | 0.532                  |                         |                       |
| Test 2                                     | Wildtype | 4044                   |             |                         | 1                      |                         |                       |
|  | TN90 I-8 | 1611                   | 60.2 %      | 3.38 x 10 <sup>-6</sup> | 0.398                  |                         |                       |
| Test 3                                     | Wildtype | 3509                   |             |                         | 1                      |                         |                       |
|  | TN90 I-8 | 1701                   | 51.5 %      | 6.55 x 10 <sup>-6</sup> | 0.485                  |                         |                       |

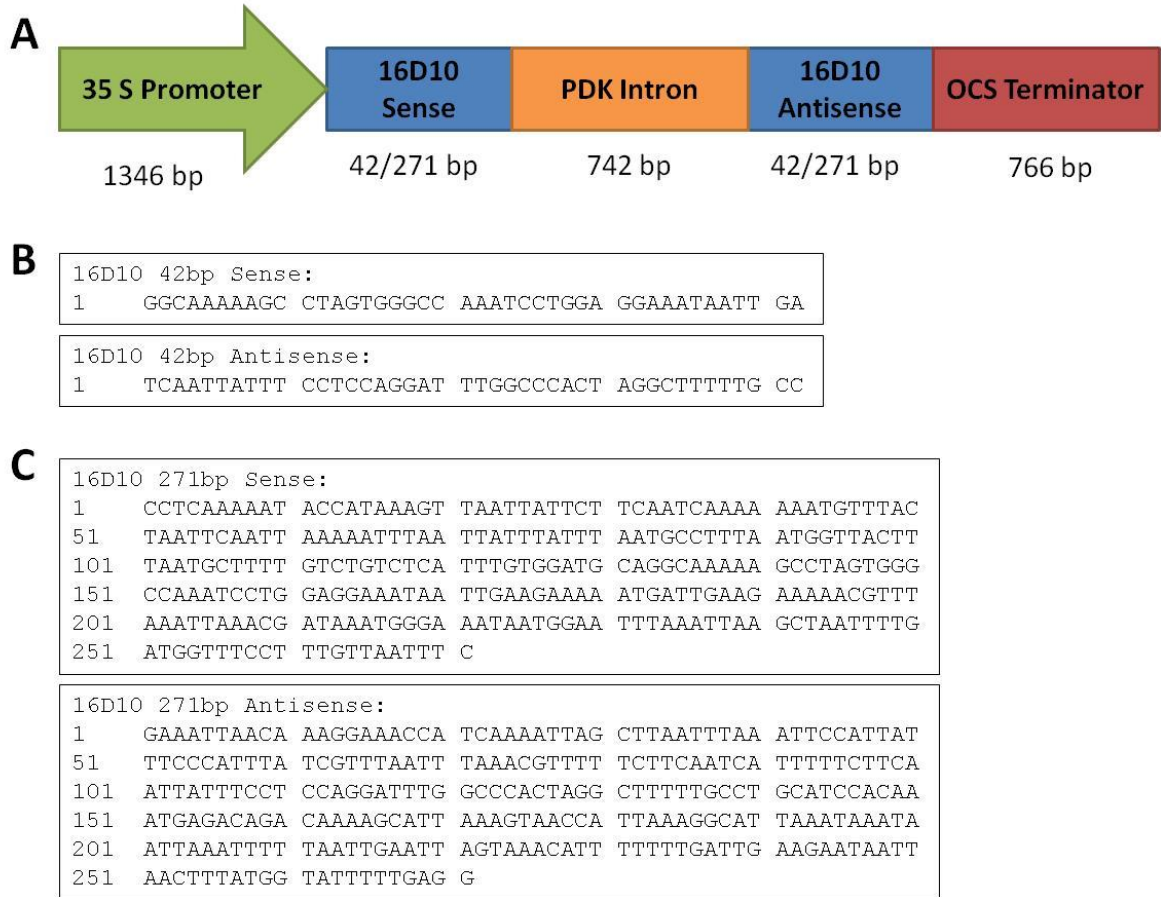
  

| <b>B. <i>M. incognita</i> with TN90 I-8</b> |          |                        |             |                |                        |                       |                       |
|---|----------|------------------------|-------------|----------------|------------------------|-----------------------|-----------------------|
| Test  | Line     | Average Eggs/g of Root | % Reduction | t-test p-value | Normalized Eggs/g Root | Between lines p-value | Between tests p-value |
| Test 1                                      | Wildtype | 2940                   |             |                | 1                      | 0.0343                | 0.318                 |
|   | TN90 I-8 | 1780                   | 42.0 %      | 0.0355         | 0.605                  |                       |                       |
| Test 2                                      | Wildtype | 4669                   |             |                | 1                      |                       |                       |
|   | TN90 I-8 | 2508                   | 52.3 %      | 0.0115         | 0.537                  |                       |                       |
| Test 3                                      | Wildtype | 688                    |             |                | 1                      |                       |                       |
|   | TN90 I-8 | 695                    | -4.36 %     | 0.487          | 1.01                   |                       |                       |

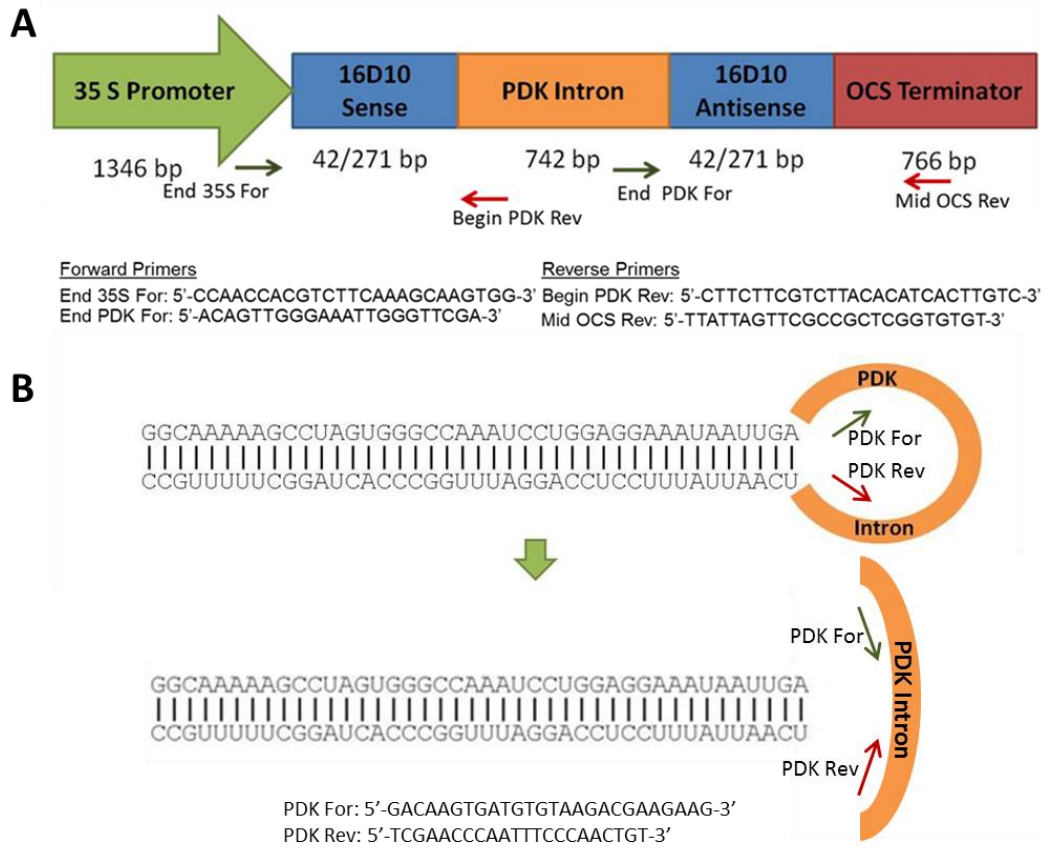
  

| <b>C. <i>M. javanica</i> with TN90 I-8</b> |          |                        |             |                         |                        |                         |                         |
|--|----------|------------------------|-------------|-------------------------|------------------------|-------------------------|-------------------------|
| Test                                       | Line     | Average Eggs/g of Root | % Reduction | t-test p-value          | Normalized Eggs/g Root | Between lines p-value   | Between tests p-value   |
| Test 1                                     | Wildtype | 2430                   |             |                         | 1                      | 1.79 x 10 <sup>-5</sup> | 7.02 x 10 <sup>-8</sup> |
|  | TN90 I-8 | 1047                   | 56.4 %      | 0.00180                 | 0.431                  |                         |                         |
| Test 2                                     | Wildtype | 9630                   |             |                         | 1                      |                         |                         |
|  | TN90 I-8 | 20073                  | -102 %      | 2.35 x 10 <sup>-5</sup> | 2.08                   |                         |                         |
| Test 3                                     | Wildtype | 6387                   |             |                         | 1                      |                         |                         |
|  | TN90 I-8 | 11434                  | -77.6 %     | 1.52 x 10 <sup>-4</sup> | 1.79                   |                         |                         |

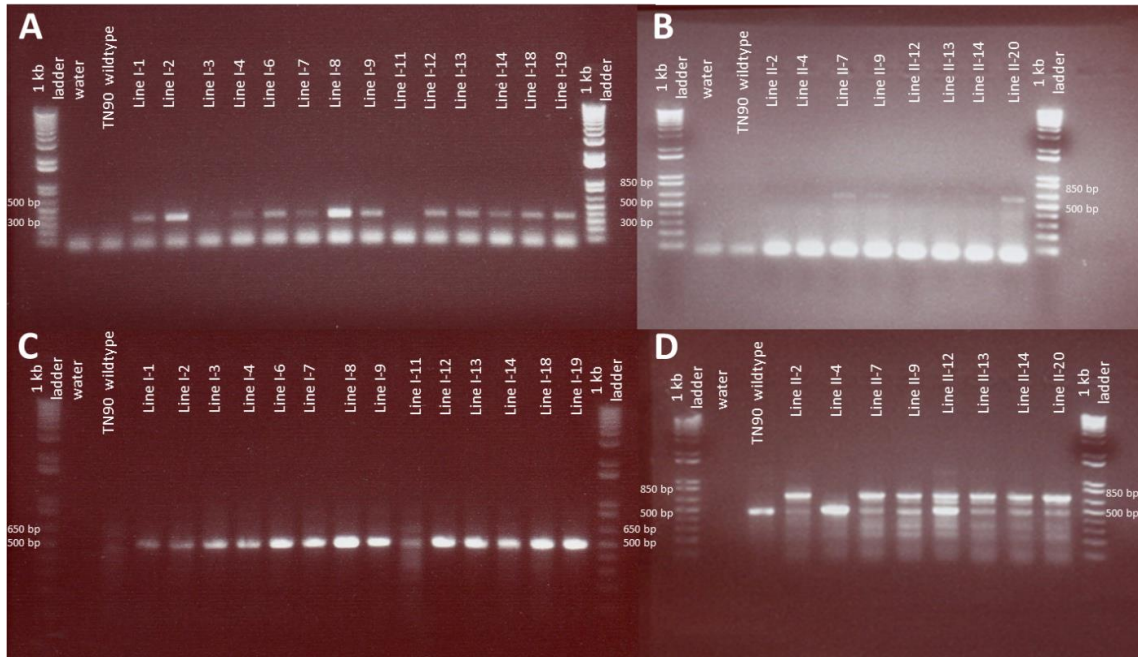




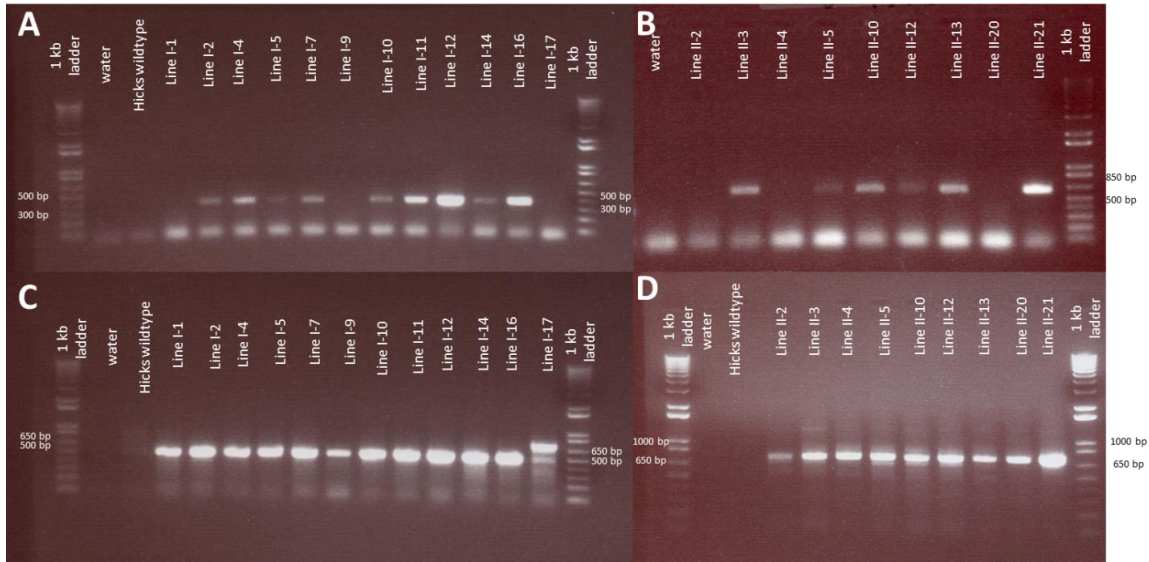
**Figure 7. Design of the transgene used for RNAi against the 16D10 gene, as designed by Huang et al. (2006, PNAS).** A. The design for the 16D10-RNAi construct used for RNA interference against the *Meloidogyne incognita* 16D10 gene. B. The 42bp sense and antisense sequences used in the 16D10-RNAi-I construct. C. The 271bp sense and antisense sequences used in the 16D10-RNAi-II construct.



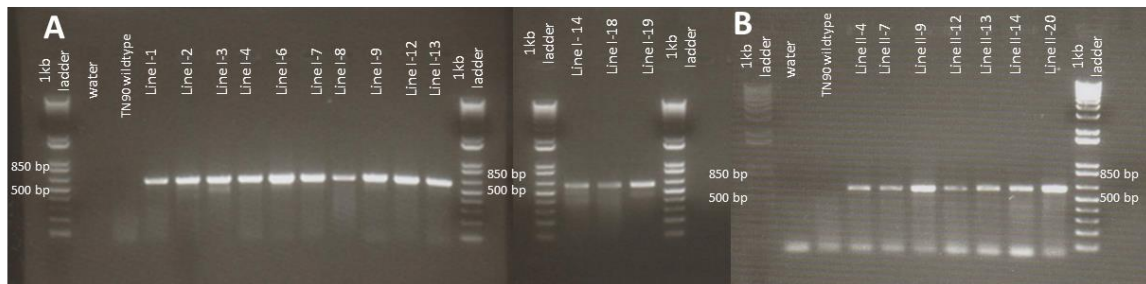
**Figure 8. PCR design and primers used to identify the 16D10RNAi constructs.** The forward and reverse primers used are listed. **A.** Scheme for PCR confirmation of the presence of the 16D10 constructs in tobacco. **B.** Scheme for PCR confirmation of the expression of the constructs from the presence of the 16D10 intron in tobacco.



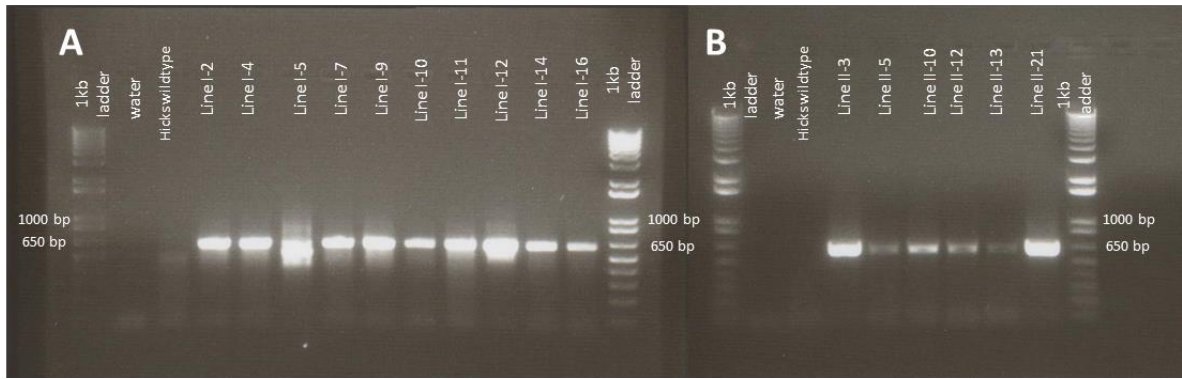
**Figure 9. PCR amplification of the 16D10RNAi construct from TN90 genomic DNA.** **A.** PCR results from TN90 16D10-I lines for the first half of the construct using the primers End 35S For and Begin PDK Rev expected to amplify a 371 bp fragment. **B.** PCR results from TN90 16D10-II lines for the first half of the construct using the primers End 35S For and Begin PDK Rev expected to amplify a 599 bp fragment. While the bands are faint, bands are present for all transformed lines except II-2 and II-4. **C.** PCR results from TN90 16D10-I lines for the second half of the construct using the primers End PDK For and mid OCS Rev expected to amplify a 513 bp fragment. **D.** PCR results from TN90 16D10-II lines for the first half of the construct using the primers End PDK For and mid OCS Rev expected to amplify a 742 bp fragment. The top band corresponds to the 16D10 RNA fragment while the bottom band (also present in wild-type) is most likely due to non-specific binding to native tobacco DNA.



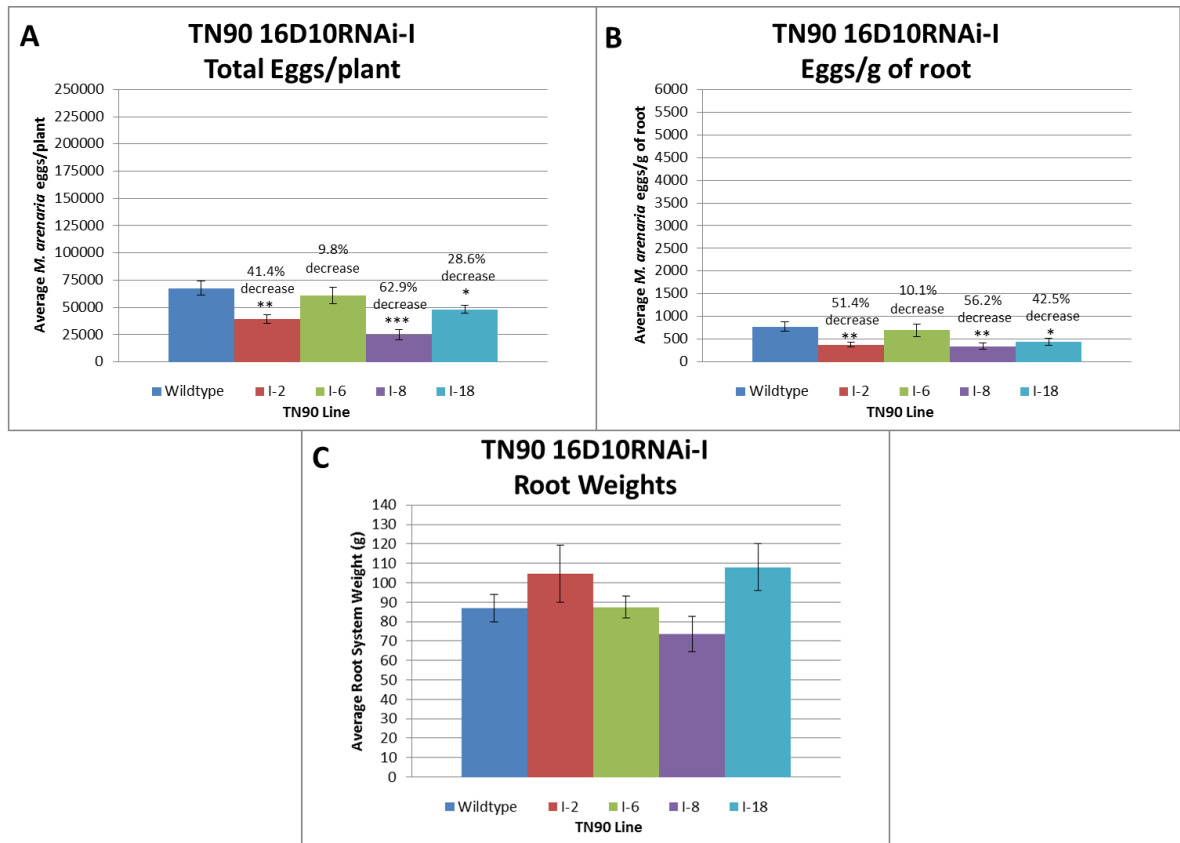
**Figure 10. PCR amplification of the 16D10RNAi construct from hicks genomic DNA.** **A.** PCR results from Hicks 16D10-I lines for the first half of the construct using the primers End 35S For and Begin PDK Rev expected to amplify a 371 bp fragment. **B.** PCR results from Hicks 16D10-II lines for the first half of the construct using the primers End 35S For and Begin PDK Rev expected to amplify a 599 bp fragment. **C.** PCR results from Hicks 16D10-I lines for the second half of the construct using the primers End PDK For and mid OCS Rev expected to amplify a 513 bp fragment. **D.** PCR results from Hicks 16D10-II lines for the first half of the construct using the primers End PDK For and mid OCS Rev expected to amplify a 742 bp fragment.



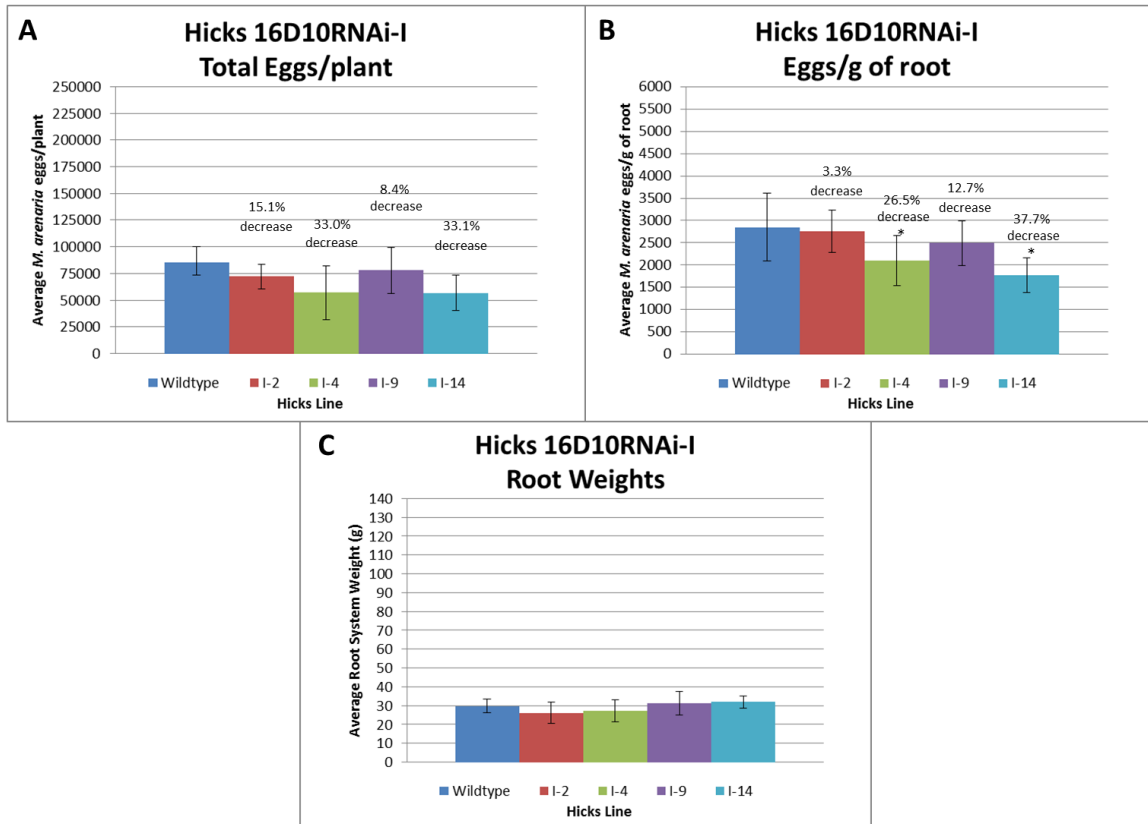
**Figure 11. Expression of the 16D10RNAi construct as measured by RT-PCR of the PDK intron using TN90 tobacco cDNA as template.** **A.** PCR results from TN90 16D10-I lines for the PDK intron using the primers PDK For and PDK Rev expected to amplify a 632 bp fragment. **B.** PCR results from TN90 16D10-II lines for the PDK intron using the primers PDK For and PDK Rev expected to amplify a 632 bp fragment.



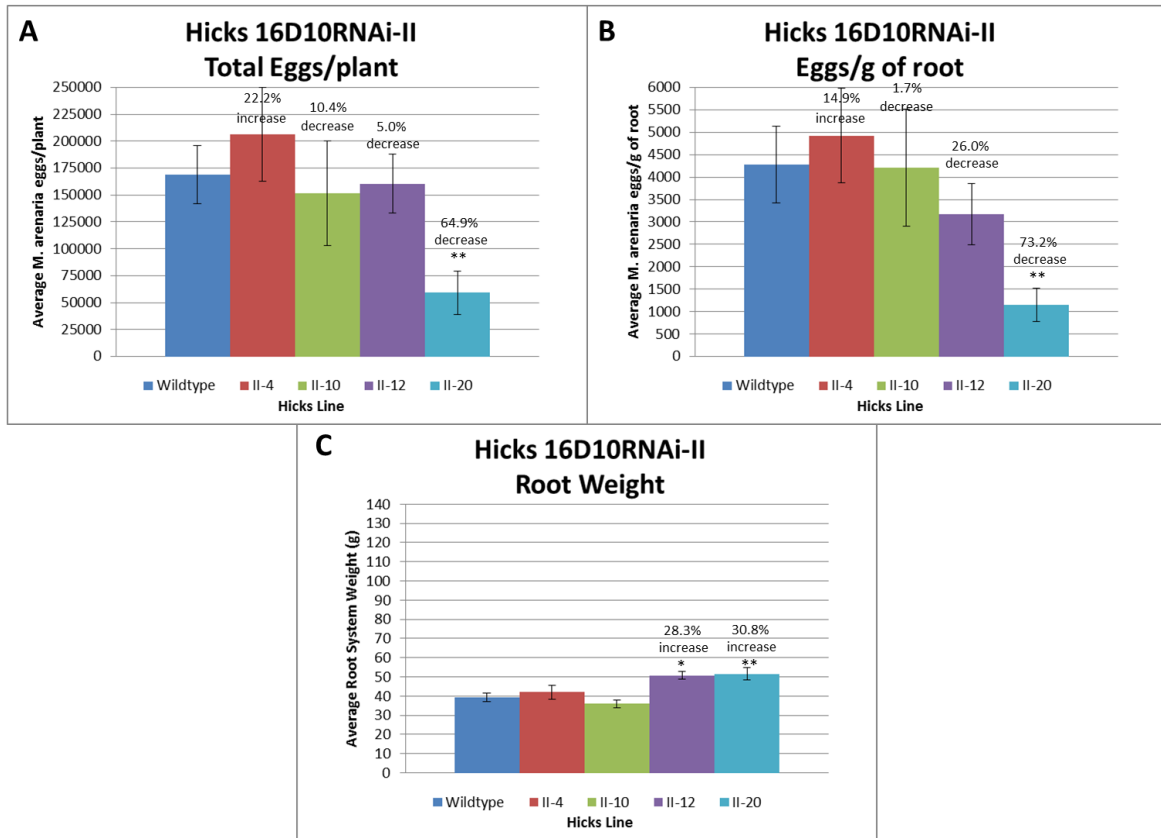
**Figure 12. Expression of the 16D10RNAi construct as measured by RT-PCR of the PDK intron using Hicks tobacco cDNA as template. A.** PCR results from Hicks 16D10-I lines for the PDK intron using the primers PDK For and PDK Rev expected to amplify a 632 bp fragment. **B.** PCR results from Hicks 16D10-II lines for the PDK intron using the primers PDK For and PDK Rev expected to amplify a 632 bp fragment.



**Figure 13. *M. arenaria* infection assay of TN90 16D10-I lines.** All p-values are from an unpaired t-test comparing the TN90 I-8 line to wildtype, with a p-value of 0.05 or less required for significance. A p-value of 0.05-0.01 is denoted by \*, a p-value of 0.01-0.001 is marked by \*\*, and a p-value of less than 0.001 is marked by \*\*\*. **A.** Results depicted using the average number of eggs/plant. Wildtype had an average of 67,533 eggs/plant. TN90 I-2 had a significantly lower (p-value of 0.0012) average of 39,600 eggs/plant for a reduction of 41.4% as compared to wildtype. TN90 I-6 was not significantly lower (p-value of 0.26) with an average of 61,000 eggs/plant for a reduction of 9.7% as compared to wildtype. TN90 I-8 had a significantly lower (p-value of  $3.8 \times 10^{-5}$ ) average of 25,067 eggs/plant for a reduction of 62.9% as compared to wildtype. TN90 I-18 had a significantly lower (p-value of 0.011) average of 48,200 eggs/plant for a reduction of 28.6% as compared to wildtype. **B.** Results depicted using the average number of eggs/g of root. Wildtype had an average of 777 eggs/g of root. TN90 I-2 had a significantly lower (p-value of 0.0019) average of 378 eggs/g of root for a reduction of 51.4% as compared to wildtype. TN90 I-6 was not significantly lower (p-value of 0.35) with an average of 698 eggs/g of root for a reduction of 10.1% as compared to wildtype. TN90 I-8 had a significantly lower (p-value of 0.0015) average of 341 eggs/g of root for a reduction of 56.2% as compared to wildtype. TN90 I-18 had a significantly lower (p-value of 0.014) average of 447 eggs/g of root for a reduction of 42.5% as compared to wildtype. **C.** Root weights of each of the lines, no significant differences in root weights were found with an  $\alpha=0.05$ .

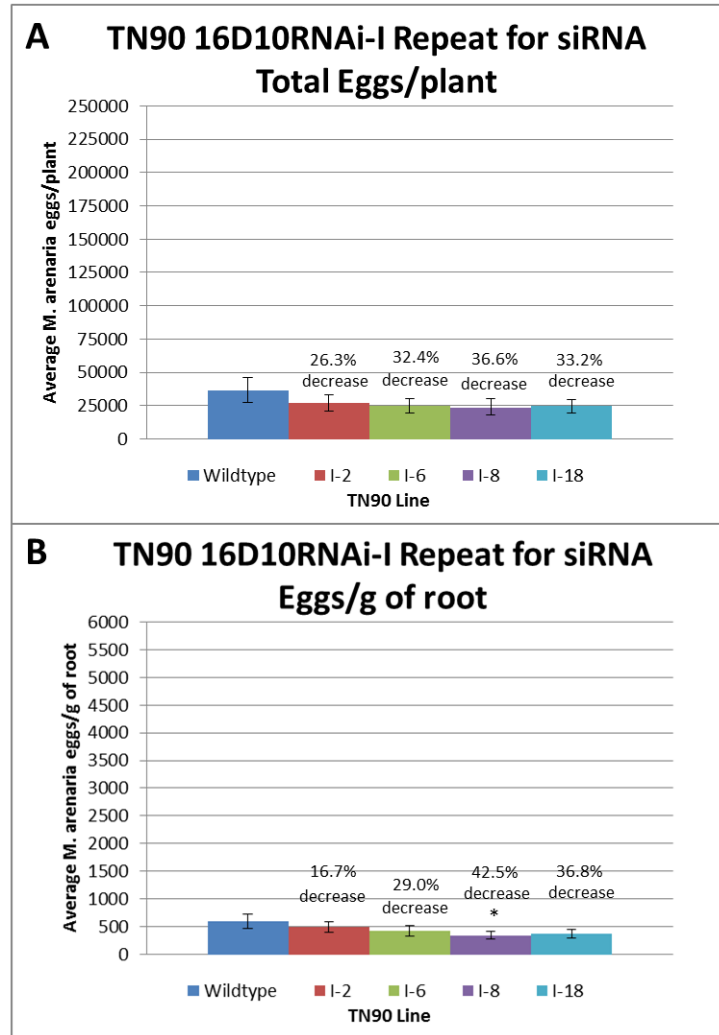


**Figure 14.** *M. arenaria* infection assay of Hicks 16D10-I lines. All p-values are from an unpaired t-test comparing the TN90 I-8 line to wildtype, with a p-value of 0.05 or less required for significance. A p-value of 0.05-0.01 is denoted by \*, a p-value of 0.01-0.001 is marked by \*\*, and a p-value of less than 0.001 is marked by \*\*\*. **A.** Results depicted using the average number of eggs/plant. Wildtype had an average of 85,067 eggs/plant. Hicks I-2 was not significantly lower (p-value of 0.25) with an average of 72,250 eggs/plant for a reduction of 15.1% as compared to wildtype. Hicks I-4 was not significantly lower (p-value of 0.18) with an average of 56,952 eggs/plant for a reduction of 33.0% as compared to wildtype. Hicks I-9 was not significantly lower (p-value of 0.39) with an average of 77,916 eggs/plant for a reduction of 8.4% as compared to wildtype. Hicks I-14 was not significantly lower (p-value of 0.11) with an average of 56,889 eggs/plant for a reduction of 33.1% as compared to wildtype. **B.** Results depicted using the average number of eggs/g of root. Wildtype had an average of 2852 eggs/g of root. Hicks I-2 was not significantly lower (p-value of 0.22) with an average of 2758 eggs/g of root for a reduction of 3.3% as compared to wildtype. Hicks I-4 had a significantly lower (p-value of 0.05) average of 2097 eggs/g of root for a reduction of 26.5% as compared to wildtype. Hicks I-9 was not significantly lower (p-value of 0.10) with an average of 2490 eggs/g of root for a reduction of 12.7% as compared to wildtype. Hicks I-14 had a significantly lower (p-value of 0.036) average of 1776 eggs/g of root for a reduction of 37.7% as compared to wildtype.

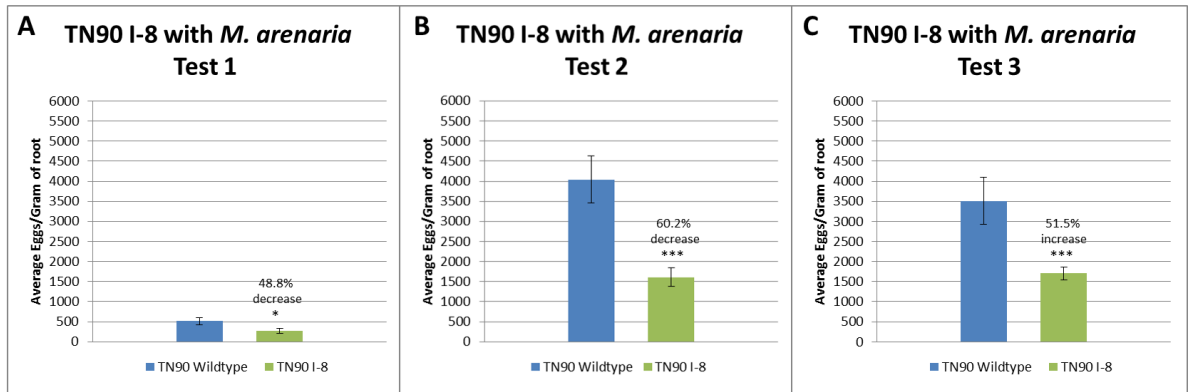


**Figure 15. *M. arenaria* infection assay of Hicks 16D10-II lines.** All p-values are from an unpaired t-test comparing the TN90 I-8 line to wildtype, with a p-value of 0.05 or less required for significance. A p-value of 0.05-0.01 is denoted by \*, a p-value of 0.01-0.001 is marked by \*\*, and a p-value of less than 0.001 is marked by \*\*\*. **A.** Results depicted using the average number of eggs/plant. Wildtype had an average of 169,037 eggs/plant. Hicks II-4 was not significantly higher (p-value of 0.30) with an average of 206,583 eggs/plant for an increase of 22.29% as compared to wildtype. Hicks II-10 was not significantly lower (p-value of 0.38) with an average of 151,400 eggs/plant for a reduction of 10.4% as compared to wildtype. Hicks II-12 was not significantly different (p-value of 0.41<sup>5</sup>) with an average of 160,533 eggs/plant for a reduction of 5.0% as compared to wildtype. Hicks II-20 had a significantly lower (p-value of 0.0026) average of 59,333 eggs/plant for a reduction of 64.9% as compared to wildtype. **B.** Results depicted using the average number of eggs/g of root. Wildtype had an average of 4283 eggs/g of root. Hicks II-4 was not significantly different (p-value of 0.47) average of 4922 eggs/g of root for an increase of 14.9% as compared to wildtype. Hicks II-10 was not significantly different (p-value of 0.42) with an average of 4208 eggs/g of root for a reduction of 1.7% as compared to wildtype. Hicks II-12 was not significantly lower (p-value of 0.15) with an average of 3169 eggs/g of root for a reduction of 26.0% as compared to wildtype. Hicks II-20 had a significantly lower (p-value of 0.0015) average of 1150 eggs/g of root for a reduction of 73.2% as compared to wildtype.

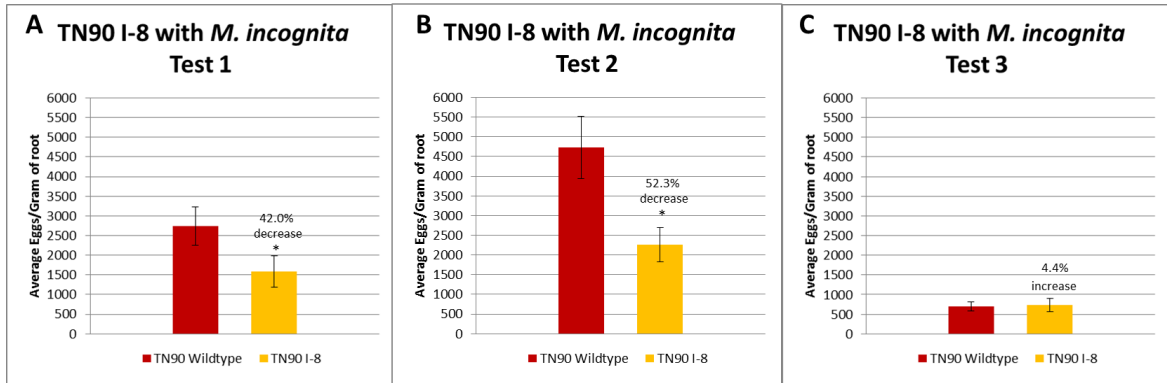




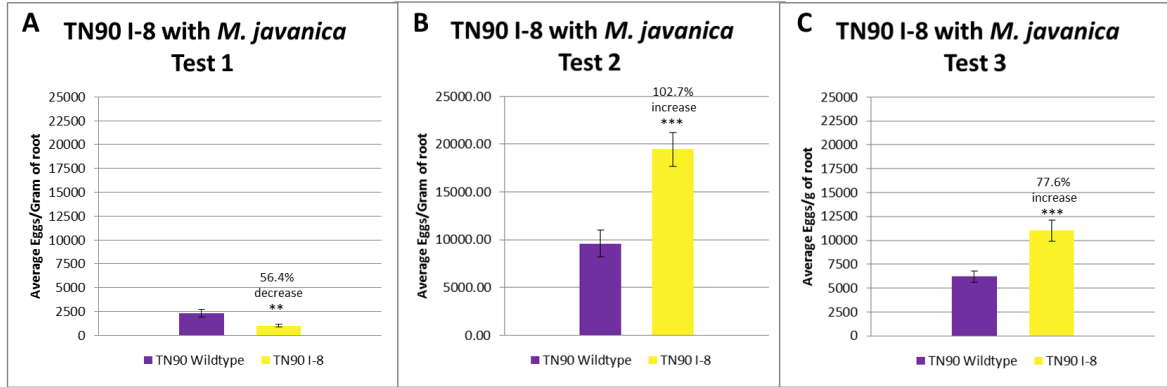
**Figure 16. *M. arenaria* infection assay repeat of TN90 16D10-I lines used for siRNA sequencing.** Total eggs per root system were extracted and quantified at 8 weeks after inoculation of each plant with 10,000 *M. arenaria* eggs and root tissue samples were analyzed for expression of 16D10 siRNA (Figure 11). **A.** Results depicted using the average number of eggs/plant. Wildtype had an average of 36,727 eggs/plant. TN90 I-2 was not significantly lower (p-value of 0.20) with an average of 27,056 eggs/plant for a reduction of 26.3% as compared to wildtype. TN90 I-6 was not significantly lower (p-value of 0.14) with an average of 24,833 eggs/plant for a reduction of 32.4% as compared to wildtype. TN90 I-8 was not significantly lower (p-value of 0.13) with an average of 23,278 eggs/plant for a reduction of 36.6% as compared to wildtype. TN90 I-18 was not significantly lower (p-value of 0.18) with an average of 24,533 eggs/plant for a reduction of 33.2% as compared to wildtype. **B.** Results depicted using the average number of eggs/g of root. Wildtype had an average of 594 eggs/g of root. TN90 I-2 was not significantly lower (p-value of 0.25) with an average of 495 eggs/g of root for a reduction of 16.7% as compared to wildtype. TN90 I-6 was not significantly lower (p-value of 0.16) with an average of 422 eggs/g of root for a reduction of 29.0% as compared to wildtype. TN90 I-8 had a significantly lower (p-value of 0.030) average of 342 eggs/g of root for a reduction of 42.5% as compared to wildtype. TN90 I-18 was not significantly lower (p-value of 0.11) with an average of 376 eggs/g of root for a reduction of 36.8% as compared to wildtype. All p-values are from an unpaired t-test comparing the TN90 I-8 line to wildtype, with a p-value of 0.05 or less required for significance. A p-value of 0.05-0.01 is denoted by \*.



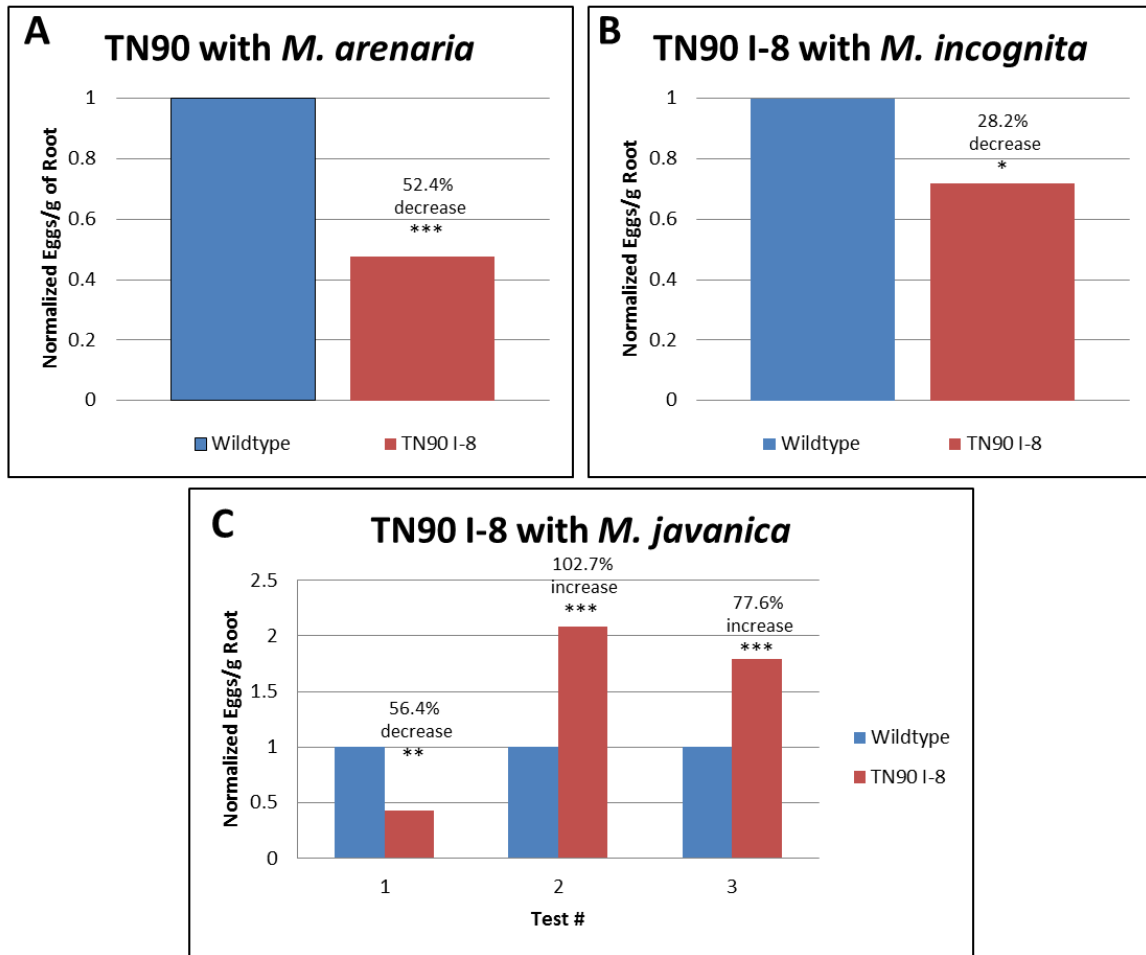
**Figure 17. TN90 I-8 *M. arenaria* infection assay results.** All p-values are from an unpaired t-test comparing the TN90 I-8 line to wildtype, with a p-value of 0.05 or less required for significance. A p-value of 0.05-0.01 is denoted by \*, a p-value of 0.01-0.001 is marked by \*\*, and a p-value of less than 0.001 is marked by \*\*\*. **A.** Results from the first infection assay, the average eggs/g of root for wildtype was 514, while the eggs/g of root for TN90 I-8 was significantly lower (p-value of 0.017) with an average of 263, a 48.8% reduction. **B.** Results from second infection assay, the average eggs/g of root for wildtype was 4404, while the eggs/g of root for TN90 I-8 was significantly lower (p-value of  $3.4 \times 10^{-6}$ ) with an average of 1611, a 60.2% reduction. **C.** Results from the third infection assay, the average eggs/g of root for wildtype was 3509, while the eggs/g of root for TN90 I-8 was significantly lower (p-value of  $6.6 \times 10^{-6}$ ) with an average of 1701, a 51.5% reduction.



**Figure 18. TN90 I-8 *M. incognita* infection assay results.** All p-values are from an unpaired t-test comparing the TN90 I-8 line to wildtype, with a p-value of 0.05 or less required for significance. A p-value of 0.05-0.01 is denoted by \*, a p-value of 0.01-0.001 is marked by \*\*, and a p-value of less than 0.001 is marked by \*\*\*. **A.** Results from the first infection assay, the average eggs/g of root for wildtype was 2739, while the eggs/g of root for TN90 I-8 was significantly lower (p-value of 0.036) with an average of 1587, a 42.0% reduction. **B.** Results from second infection assay, the average eggs/g of root for wildtype was 4731, while the eggs/g of root for TN90 I-8 was significantly lower (p-value of 0.012) with an average of 2257, a 52.3% reduction. **C.** Results from the third infection assay, the average eggs/g of root for wildtype was 698, while the eggs/g of root for TN90 I-8 was not significantly different (p-value of 0.48) with an average of 729, a 4.4% increase.



**Figure 19. TN90 I-8 *M. javanica* infection assay results.** All p-values are from an unpaired t-test comparing the TN90 I-8 line to wildtype, with a p-value of 0.05 or less required for significance. A p-value of 0.05-0.01 is denoted by \*, a p-value of 0.01-0.001 is marked by \*\*, and a p-value of less than 0.001 is marked by \*\*\*. **A.** Results from the first infection assay, the average eggs/g of root for wildtype was 2302, while the eggs/g of root for TN90 I-8 was significantly lower (p-value of 0.0018) with an average of 1004, a 42.0% reduction. **B.** Results from second infection assay, the average eggs/g of root for wildtype was 9594, while the eggs/g of root for TN90 I-8 was significantly higher (p-value of  $2.3 \times 10^{-5}$ ) with an average of 19446, a 102.7% increase. **C.** Results from the third infection assay, the average eggs/g of root for wildtype was 6205, while the eggs/g of root for TN90 I-8 was significantly higher (p-value of 0.0002) with an average of 11019, a 77.6% increase.



**Figure 20. Normalized data from the TN90 I-8 infection assays with multiple *Meloidogyne* spp.** P-values of 0.05 or less are required for significance. A p-value of 0.05-0.01 is denoted by \*, a p-value of 0.01-0.001 is marked by \*\*, and a p-value of less than 0.001 is marked by \*\*\*. **A.** Normalized results from the TN90 I-8 infection assays with *M. arenaria*. The average of the 3 tests combined is shown since a two factor (Table 4A) showed that the test repeat did not have a significant effect on the assay. The average percent decrease for the 3 repeated tests is shown and the p-value was derived from a two factor anova (Table 4A). **B.** Normalized results from the TN90 I-8 infection assays with *M. incognita*. The average of the 3 tests combined is shown since a two factor anova (Table 4B) showed that the test repeat did not have a significant effect on the assay. The average percent decrease for the 3 repeated tests is shown and the p-value was derived from a two factor anova (Table 4B). **C.** Normalized results from the TN90 I-8 infection assays with *M. javanica*. The 3 test results are shown individually since a significant test effect was observed using a two factor anova (Table 4C). The average percent decrease for each individual test repeat is shown and the p-values were derived from un-paired t-tests (Table 4C).

## **MODIFICATIONS OF 16D10RNAi CONSTRUCTS FOR POTENTIAL IMPROVED EXPRESSION IN *ARABIDOPSIS THALIANA***

### **Abstract**

Root-knot nematodes are plant-parasitic nematodes that invade plant roots and set up a feeding site composed of large multinucleate giant-cells. These cells are created by the nematode through proteinaceous nematode stylet secretions. These stylet secretions are produced by specialized esophageal gland cells in the nematode and several have been shown to be crucial for successful establishment of a feeding site and nematode survival. One of the proteins secreted is 16D10, which has been shown to be important for nematode survival. Previous studies have used host-derived RNAi targeting the *16D10* gene, and have seen high levels of nematode resistance in the resulting transgenic plants. Currently, all work with 16D10RNAi has been performed using the pHANNIBAL vector, which utilizes the CaMV 35S promoter and the PDK intron as a spacer. Using this vector system in tobacco did produce resistant plants, but the resistance was not as great as was seen in the initial studies with *Arabidopsis thaliana*. The objective of this research was to design and create new 16D10 siRNA expression vectors in an attempt to improve siRNA expression. For this research, the 35S promoter was exchanged for two new promoters, *Gmubi* and *Ntcel7*. *Gmubi* is a constitutive promoter that has been shown to result in greater expression in soybean than 35S. The *Ntcel7* promoter is generally only expressed in shoot and root meristematic tissue and weakly expressed in the vasculature, but has been shown to be up-regulated in giant-cells. In order to determine if better splicing of the intron spacer might result in better

dsRNA production, the GUS spacer was also substituted for the PDK intron. All vectors were successfully assembled and transformed into *Agrobacterium tumefaciens*. All of the constructs have been transformed into *Arabidopsis thaliana* using the floral-dip method, and selfing in order to obtain homozygous lines is currently underway. The resulting lines will be tested for nematode resistance using root-knot nematode infection assays.

## **Introduction**

Members of the genus *Meloidogyne*, or root-knot nematodes, are sedentary endoparasites of plant roots that cause an estimated 10 billion dollars in crop losses annually worldwide. The four most economically important species are *M. incognita* (southern root-knot nematode), *M. javanica* (Javanese root-knot nematode), *M. arenaria* (peanut root-knot nematode), and *M. hapla* (northern root-knot nematode) (Sasser et al., 1983). Root-knot nematodes have wide host ranges, and cause damage by infecting and galling plant roots (Sasser, 1980). These galls are nutrient sinks that disrupt translocation and cause stunting and reduced yields or even death in the host plant. Root-knot nematode infection can also predispose the roots to secondary infections by other pathogens (Mayol and Bergeson, 1970). Nematodes penetrate the root as second-stage juveniles and move intercellularly to the vascular bundles where they become sedentary as they establish a feeding site. Feeding sites are comprised of several giant-cells, multinucleate hypertrophic plant cells that arise from karyokinesis without cytokinesis (Huang, 1985; Hussey, 1985). Hyperplasia of the cells surrounding the giant-cells also occurs, forming the characteristic root galls. Root-knot nematodes secrete effector proteins from their esophageal gland cells into the plant cell through their stylets, which are hollow spears (Bird and Saurer, 1967; Bird, 1968;

Sundermann and Hussey, 1988). These secreted proteins are thought to be involved in giant-cell formation, which is critical to a successful host-parasitic interaction and subsequent nematode reproduction (Hussey, 1989; Davis et al., 2004).

In an effort to identify the effector proteins in the root-knot nematode secretome, Huang et al. (2003) microaspirated the gland cells of 10 different stages of root-knot nematode and created cDNA libraries. After EST analysis, 37 putative parasitism genes were identified that were unique to the gland cells and had a signal peptide signaling them for secretion (Huang et al., 2003). One of these genes, *16D10*, was localized to the subventral glands and was produced in both second-stage juveniles and adult females. This gene encoded a small protein, 13aa in length, less than half the size of its secretion signal peptide (30 aa). BLAST searches indicated the 16D10 protein was a novel protein. Western dot blots and ELISA of stylet secretions showed that the 16D10 protein was secreted from the stylet and a southern blot showed that *16D10* was conserved in all four major species of root-knot nematode, but absent from 2 other nematode species, *Heterodera glycines* and *Caenorhabditis elegans*. It was also not found in either of the two plants tested, *Nicotiana tabacum* or *Arabidopsis thaliana* (Huang et al., 2006a). In order to analyze the function of the *16D10* gene, 16D10 was overexpressed in *Arabidopsis thaliana* (Huang et al., 2006a). The resulting transgenic plants had significantly increased root lengths due to increased root cell division, indicating 16D10 might play a role in gall formation (Huang et al., 2006a). A yeast-two-hybrid assay showed that 16D10 interacts with the SAW domain of a plant SCARECROW-like transcription factor (Di Laurenzio et al., 1996), leading to the conclusion that the *16D10* gene might function as a peptide signaling molecule (Huang et al., 2006a).



Huang et al. (2006b) used RNA interference (RNAi) to knock down *16D10* gene expression to test the importance of 16D10 in giant-cell formation. Root-knot nematode second-stage juveniles were induced to ingest 16D10 dsRNA *in vitro*, resulting in strong inhibition of the 16D10 transcript and decreased ability to infect and survive to produce eggs in host plant roots. *Arabidopsis thaliana* was then transformed with two different 16D10 dsRNA constructs using floral dip with *Agrobacterium tumefaciens* (Huang et al., 2006b). These constructs were created in the pHANNIBAL vector (Wesley et al., 2001) which has a kanamycin resistance gene as a selective marker and is driven by the CaMV 35S promoter, which is highly constitutively expressed in virtually all plant species (Weising et al., 1988; Benfey and Chua, 1990) and is designed to produce a hairpin RNAi construct. Huang et al. (2006b) cloned into the pHANNIBAL vector either 42bp or 271 bp of *16D10* sense and antisense sequence, with the PDK intron from the pHANNIBAL vector acting as a spacer. Root-knot nematode infection assays of pHANNIBAL::16D10RNAi transformed *Arabidopsis* plants were shown to have significantly fewer galls (63-90% reduction) and eggs (69-93% reduction) than *Arabidopsis* transformed with an empty vector control. This indicated that feeding the root-knot nematodes the 16D10 dsRNA using a host plant to deliver the dsRNA was an efficient way to achieve resistance in transformed host plants.

While our research (Chapter 1) with tobacco (*Nicotiana tabacum*) transformed with the original 16D10RNAi constructs made by Huang et al. (2006b) provided approximately 40-60% reduction in root-knot nematode reproduction, the transgenic tobacco did not display as high a level of root-knot nematode resistance (Chapter 1) as the *Arabidopsis* (~60-90% reduction) transformed by Huang et al. (2006b). The purpose of the research below is to

determine if vector improvements could increase the level of 16D10RNAi expression in plants and the nematode resistance obtained when using such constructs. The CaMV 35S promoter originally used in the 16D10RNAi constructs (Huang et al., 2006b) is one of the most common promoters for transgenic expression in plants (Venter, 2007), but there are other highly expressed constitutive promoters available, some of which produce greater expression than 35S. One such promoter is the soybean (*Glycine max*) polyubiquitin promoter (*Gmubi*), a constitutive promoter that was first isolated by Chiera et al. (2007) from *Glycine max* (L.) Merr. *Gmubi* was shown to have an expression level more than five times greater than the 35S promoter when expressed in lima bean (*Phaseolus lunatus* L.) seeds (Chiera et al., 2007). The *Gmubi* promoter also showed high constitutive expression in transgenic soybean (Hernandez-Garcia et al., 2009), including root tissues. As opposed to constitutive promoters, nematode-inducible plant promoters represent an alternative to more efficiently express transgenes targeted to parasitic nematodes. The *Nicotiana tabacum cellulose 7* (*Ntcel7*) gene (Goellner et al., 2001) and its promoter (Wang et al., 2007) are strongly expressed in both root-knot and cyst nematode feeding sites and induced by auxin. The *Ntcel7* promoter is also expressed in shoot and root meristematic tissue and weakly expressed in the vasculature but it is most highly expressed in giant-cells and cyst nematode syncytia in heterologous plant species, making it a potentially useful promoter for targeted genetic engineering of resistance to these nematodes (Wang et al., 2007). Also, this promoter has already been successfully used by Patel et al. (2010) to silence the *Hs4F01* gene in *Heterodera schachtii* by using the *Ntcel7* promoter to drive a hairpin construct targeting the *Hs4F01* gene in *Arabidopsis thaliana*.

Another modification that can be made to the RNAi construct is changing the intron spacer, since proper splicing of the intron is important for dsRNA production (Wesley et al., 2001). Splice sites for intron spacers are determined by both the sequence of the intron and the sequence of the surrounding construct (Hebsgaard et al., 1996), and splice site prediction is available for intron constructs in *Arabidopsis* via the website NetPlantGene (<http://www.cbs.dtu.dk/services/NetPlantGene/>), produced by Hebsgaard et al. (1996). One possible alternative spacer is the GUS spacer, a portion of the GUS gene (Li et al., 2010), which has previously been used as a spacer for other RNAi constructs (Li et al., 2010).

The goal of this research was to create new 16D10RNAi constructs driven by the *Gmubi* or *Ntcel7* promoters, as well as new constructs utilizing the GUS spacer instead of the PDK intron. All of these new constructs will be transformed into *Arabidopsis*, and the levels of resistance to root-knot nematode will be compared to *Arabidopsis* with the original 16D10RNAi constructs (Huang et al., 2006b).

## **Materials and Methods**

### Vector Cloning

The original vectors used by Huang et al. (2006b) were obtained from Dr. Richard Hussey at the University of Georgia and included the pHANNIBAL:16D10RNAi-1 and pHANNIBAL:16D10RNAi-2 constructs, both in the pART27 binary vector (Gleave, 1992). Both original RNAi constructs were driven by the constitutive CaMV 35S promoter and both contained the PDK intron (Wesley et al., 2001) as the RNAi hairpin loop (Figure 21A). The 16D10RNAi-1 construct contained a 42 bp sense and antisense segment that corresponded to

the 16D10 peptide coding sequence (Figure 21B), while the 16D10RNAi-2 construct contained a 271 bp sense and antisense segment (Figure 21C) that corresponded to the 16D10 peptide plus signal peptide. The 35S:GFPRNAi:PDK vector was included as a (non-nematode or plant) negative control and was obtained from Hamamouch et al. (2012) (Figure 22).

An outline of the design of the twelve new 16D10RNAi vector constructs is shown in Figure 23. The *Gmubi* promoter was obtained from Chiera et al. (2007) and was modified by adding a SacI site to the 5' end and a XhoI site to the 3' end via PCR amplification. A restriction digest using the SacI and XhoI cut sites was performed and the *Gmubi* promoter fragment (983bp) was isolated using gel electrophoresis and gel purification (QIAquick Gel Extraction Kit from Qiagen). A restriction digest using the SacI and XhoI cut sites was also used to remove the 35S promoter from each of the three existing RNAi vectors (16D10-1:PDK, 16D10-2:PDK, and GFPRNAi:PDK). The vector fragments (13.26kb for the 16D10-1:PDK vector, 13.717 kb for the 16D10-2:PDK vector and 14.821kb for the GFPRNAi:PDK vector) were isolated again using gel electrophoresis and gel purification. The *Gmubi* promoter was then added to all three of the RNAi vectors using the T4 DNA ligase kit (Invitrogen).

To create the constructs with the *Ntcel7* promoter, the *Ntcel7* promoter used by Wang et al. (2007) was obtained and a restriction digest using the SacI and XhoI cut sites was performed. The *Ntcel7* promoter fragment (1483b) was isolated using gel electrophoresis and gel purification (QIAquick Gel Extraction Kit from Qiagen). A new SacI and XhoI restriction digest was used to remove the 35S promoter from all three existing RNAi vectors described

immediately above. The vector fragments were isolated using gel electrophoresis and gel purification (QIAquick Gel Extraction Kit from Qiagen). The *Ntcel7* promoter was then added to all of the RNAi vectors using the T4 DNA ligase kit (Invitrogen).

A vector containing the GUS spacer was obtained from Li et al. (2010). To add the GUS spacer to the 16D10RNAi vectors, KpnI and ClaI restriction sites were introduced using primers designed to amplify the GUS spacer from the obtained vector with the added KpnI and ClaI restriction sites (KpnI GUS For: 5'-

AAAAAAGGTACCATCTACCCGCTTCGCGTCGGC-3' and ClaI GUS Rev: 5'-

AAAAAAATCGATCGAGTGAAGATCCCTTTCTTGTTACC-3'). The amplified GUS

spacer was then digested with KpnI and ClaI. The resulting GUS spacer fragment (929 bp)

was isolated using gel electrophoresis and gel extraction. A KpnI and ClaI restriction digest

was used to remove the PDK intron from the two 16D10RNAi vectors. The RNAi vector

fragments (13.838 kb for the 35S:16D10-1 vector, 14.295 kb for the 35S:16D10-2 vector)

were isolated using gel electrophoresis and gel purification (QIAquick Gel Extraction Kit

from Qiagen). The GUS spacer fragment was then added to the two 16D10RNAi vectors

using the T4 DNA ligase kit (Invitrogen). To add the GUS spacer to GFPRNAi vector, the

KpnI and HindIII restriction sites were introduced using primers designed to amplify the

GUS spacer with the added restriction sites (KpnI GUS For: 5'-

AAAAAAGGTACCATCTACCCGCTTCGCGTCGGC-3' and HindIII GUS Rev: 5'-

AAAAAAAAGCTTCGAGTGAAGATCCCTTTCTTGTTACC-3'). The amplified GUS

spacer was then digested with KpnI and HindIII. The resulting fragment (928 bp) was

isolated using gel electrophoresis and gel extraction. A KpnI and HindIII restriction digest

was used to remove the PDK intron from the GFPRNAi vector. The remaining GFPRNAi vector fragment (15.393kb) was isolated using gel electrophoresis and gel purification (QIAquick Gel Extraction Kit from Qiagen). The GUS spacer fragment was then added to the GFPRNAi vector using the T4 DNA ligase kit (Invitrogen).

Each construct was transformed into chemically competent *E. coli* in order to replicate the constructs. Plasmid DNA extraction using the Zyppy Plasmid Miniprep Kit (Zymo Research) was used to extract the plasmid DNA. All twelve constructs were DNA sequenced to confirm the successful assembly of the construct and to ensure that no mutations were present. The constructs were then transformed into both ElectroMAX™ *Agrobacterium tumefaciens* LBA4404 (Invitrogen) and electrocompetent *Agrobacterium tumefaciens* strain GV 3101 using electroporation (2.0kV, 200Ω, 25μF).

#### *Arabidopsis thaliana* Transformation and DNA Extraction

*Arabidopsis thaliana* Col-0 plants were grown in the greenhouse until flowering, and preformed siliques were excised immediately prior to the first floral dip. Transformation of the twelve vectors into *Arabidopsis* was performed using the floral dip method described by Clough and Bent (1998), was repeated after 3-5 days, and repeated for a third dip after another 3-5 days. Plants were allowed to continue growing for another 3-5 weeks until T<sub>0</sub> seeds were ready for collection. Collected *Arabidopsis* seeds were sterilized using 10% bleach for 4 min followed by 70% ethanol for 1 min, and finished with 4 washes with sterile deionized water. After surface-sterilization the seeds were plated on MS medium with 50mg/L kanamycin for selection. Surviving seedlings were transferred to soil and grown in

the greenhouse until the leaves were at least 1 cm in length at which point an approximately 100mg sample was taken and DNA was extracted using DNA extraction buffer with SDS (Dellaporta et al., 1983). The transgenic *Arabidopsis thaliana* plants were then allowed to continue growing in the greenhouse and allowed to self-fertilize. The T<sub>1</sub> seeds were collected, and segregation analysis using kanamycin selection is currently underway in order to identify homozygous transgenic plant lines.

#### PCR Confirmation of the Presence of the Insert

DNA extracted from each line was tested for the presence of the complete new 16D10RNAi insert using PCR (Figure 23). Both the front (from the 35S promoter to the PDK intron) and the back (from the PDK intron through the OCS terminator) of the RNAi constructs were PCR amplified using the primers listed in Figure 23, and only the lines with PCR fragments of the right size from both the front and back of the construct were considered to be positive for the presence of construct.

#### **Results**

All twelve constructs (Figure 23) were successfully assembled and sequenced to confirm correct construction. The constructs were then cloned into *Agrobacterium tumefaciens* LBA4404 and floral dips of *Arabidopsis thaliana* Col-0 were performed. Unfortunately after several repeated transformation attempts only one of the transformation attempts for one of the constructs, 35S:16D10-2:GUS, was successful. This attempt resulted in 11 lines of *Arabidopsis* that survived kanamycin selection; PCR confirmation of these

lines has not yet been performed. Since transformation of Arabidopsis with the LBA 4404 strain had not proved effective, the constructs were all transformed into another strain of agrobacteria that has been shown to efficiently transform Arabidopsis with floral dip, GV3101, (Hamamouch et al., 2012). This strain resulted in successful transformation of all 12 constructs. For 35S:16D10-1:PDK, 13 lines were selected using kanamycin resistance, and the presence of the complete construct has been confirmed by PCR for 10 of those lines (Figure 24). For 35S:16D10-2:PDK, 3 lines were selected using kanamycin resistance; the presence of the complete construct has not yet been tested. For 35S:GFPRNAi:PDK, 12 lines were selected using kanamycin resistance; the presence of the complete construct has been confirmed for 6 of those lines (Figure 25). For 35S:16D10-1:GUS, 1 line was selected using kanamycin resistance, and the presence of the complete construct has been confirmed (Figure 26). For 35S:16D10-2:GUS, 12 lines were selected using kanamycin resistance; the presence of the complete construct has been confirmed for 2 lines (Figure 27). For 35S:GFPRNAi:GUS, more than 100 lines were selected using kanamycin resistance; the presence of the complete construct has been confirmed for 5 lines (Figure 28). For Ntcel7:16D10-1:PDK, 11 lines were selected using kanamycin resistance, and the presence of the complete construct has been confirmed for all 11 lines, although the PCR results did show only faint bands for line 20 (Figure 29). For Ntcel7:16D10-2:PDK, 2 lines were selected using kanamycin resistance; the presence of the complete construct has not yet been tested. For Ntcel7:GFPRNAi:PDK, 4 lines were selected using kanamycin resistance; the presence of the complete construct has not yet been tested. For Gmubi:16D10-1:PDK, 6 lines were selected using kanamycin resistance, and the presence of the complete construct has



been confirmed for 2 of those lines (Figure 30). For Gmubi:16D10-2:PDK, 3 lines were selected using kanamycin resistance and the presence of the complete construct in all 3 lines was confirmed by PCR (Figure 31). For Gmubi:GFPRNAi:PDK, 7 lines were selected using kanamycin resistance; the presence of the complete construct has been confirmed by PCR for 3 of those lines (Figure 32). The complete list of the number of lines for each construct and the number of lines with PCR confirmation is shown in Table 5.

## **Discussion**

In an attempt to improve 16D10RNAi expression in plants, the 35S promoter and PDK intron of the original construct (Huang et al., 2006b) were replaced by either the constitutive *Gmubi* (Chiera et al., 2007) or nematode-inducible *Ntcel7* (Wang et al., 2007) promoter and a GUS spacer intron (Li et al., 2010) in a factorial design. Construction of all twelve new 16D10RNAi constructs and transformation into *Arabidopsis thaliana* via floral dip were successful. While several lines from most of the constructs (Table 5) have been confirmed to be successful transformants via PCR (Figures 24-32), confirmation of transformed lines from 3 of the constructs (35S:16D10-2:PDK, *Ntcel7*:16D10-2:PDK, and *Ntcel7*:16D10-2:PDK) has yet to be achieved. At least five confirmed transformed lines need to be obtained from each construct to test the efficacy of the new constructs, and to date only four constructs have at least five lines confirmed by PCR (Figure 33). Work is currently underway to extract DNA from those lines that have not yet been checked for the presence of the construct by PCR. More seeds are also being screened in an effort to find more

transformants from all of the 16D10RNAi constructs that do not yet have five transformed lines.

The next step in this research will be to obtain homozygous lines of transformed *Arabidopsis* through self-pollination and selection. Once homozygosity is achieved for all 12 constructs, root-knot nematode infection assays and siRNA analysis (see Chapter 1) will be performed to determine the levels of siRNA expression for each construct and to determine which constructs are the most efficient at achieving nematode resistance through silencing. Once the constructs yielding the greatest resistance have been determined, they can be used to transform crops such as tobacco (see Chapter 1). Also, if these constructs increase the resistance conferred by the 16D10RNAi, they may be used for RNAi against other nematode parasitism genes. One potential target is 8D05, another root-knot nematode parasitism gene discovered by Huang et al. (2003). RNAi against this gene using the pHANNIBAL vector (Wesley et al., 2001) has recently been shown to result in root-knot nematode infection reductions of 73-90% (Xue et al., 2013) in *Arabidopsis*. The potential to develop a more efficient vector to express RNAi targeted to selected nematode genes can provide a means to improve and accelerate development of novel nematode-resistance in desired crop cultivars.

## References

Benfey, PN, and Chua, NH. 1990. The cauliflower mosaic virus 35S promoter: combinatorial regulation of transcription in plants. *Science* 250:959-966

- Bird, AF, and Saurer, W. 1967. Changes associated with parasitism in nematodes. II. Histochemical and microspectrophotometric analyses of preparasitic and parasitic larvae of *Meloidogyne javanica*. *Journal of Parasitology* 53:1262-1269
- Bird, AF. 1968. Changes associated with parasitism in nematodes. IV. Cytochemical studies on the ampulla of the dorsal esophageal gland of *Meloidogyne javanica* and on exudations from the buccal stylet. *J. Parasitol.* 54:879-890
- Chiera, JM, Bouchard, RA, Dorsey, SL, Park, E, Buenrostro-Nava, MT, Ling, PP, and Finer, JJ. 2007. Isolation of two highly active soybean (*Glycine max* (L.) Merr.) promoters and their characterization using a new automated image collection and analysis system. *Plant Cell Rep.* 26:1501-1509
- Davis, EL, Hussey, RS, and Baum, TJ. 2004. Getting to the roots of parasitism by nematodes. *Trends Parasitol.* 20:134-141
- Dellaporta, SL, Wood, J, and Hicks, JB. 1983. A plant DNA miniprep: version II. *Plant Mol Biol Rep* 1:19-21
- Di Laurenzio, L, WysockaDiller J, Malamy, JE, Pysh, L, Helariutta, Y, Freshour, G, Hahn, MG, Feldmann, KA, and Benfey, PN. 1996. The *SCARECROW* gene regulates an asymmetric cell division that is essential for generating the radial organization of the Arabidopsis root. *Cell* 86:423-433
- Gleave, AP. 1992. A versatile binary vector system with a T-DNA organisational structure conducive to efficient integration of cloned DNA into the plant genome. *Plant Molecular Biology* 20:1203-1207
- Goellner, M, Wang, X, and Davis, EL. 2001. Endo- $\beta$ -1,4-glucanase expression in compatible plant-nematode interactions. *Plant Cell* 13:2241-2255
- Hamamouch, N, Li, C, Hewezi, T, Baum, TJ, Mitchum, MG, Hussey, RS, Vodkin, LO, and Davis, EL. 2012. The interaction of the novel 30C02 cyst nematode effector protein with a plant beta-1,3 endoglucanase may suppress host defence to promote parasitism. *Journal of Experimental Botany* 63:3683-3695
- Hernandez-Garcia, CM, Martinelli, AP, Bouchard, RA, and Finer, JJ. 2009. A soybean (*Glycine max*) polyubiquitin promoter gives strong constitutive expression in transgenic soybean. *Plant Cell Rep.* 28:837-849
- Huang, CS. 1985. Formation, anatomy, and physiology of giant cells induced by root-knot nematodes. In: Sasser, JN, and Carter, CC (eds). An advanced treatise on *Meloidogyne*, vol 1, biology and control. North Carolina State University Graphics, Raleigh, NC pp.155-164

- Huang, GZ, Gao, B, Maier, T, Allen, R, Davis, EL, Baum, TJ, and Hussey, RS. 2003. A profile of putative parasitism genes expressed in the esophageal gland cells of the root-knot nematode *Meloidogyne incognita*. *Mol. Plant-Microbe Interact.* 16:376-381
- Huang, GZ, Dong, R, Allen, R, Davis, EL, Baum, TJ, and Hussey, RS. 2006a. A root-knot nematode secretory peptide functions as a ligand for a plant transcription factor. *Mol. Plant-Microbe Interact* 19:463-470
- Huang, GZ, Allen, R, Davis, EL, Baum, TJ, and Hussey, RS. 2006b. Engineering broad root-knot resistance in transgenic plants by RNAi silencing of a conserved and essential root-knot nematode parasitism gene. *Proc. Natl. Acad. Sci. USA* 103(39):14302-14306
- Hussey, RS. 1985. Host-parasite relationships and associated physiological changes. In: Sasser, JN, and Carter, CC (eds). An advanced treatise on *Meloidogyne*, vol I, biology and control. North Carolina State University Graphics, Raleigh, NC, pp. 143-153
- Hussey, RS. 1989. Disease-inducing secretions of plant-parasitic nematodes. *Annu. Rev. Phytopathol.* 27:123-141
- Li, JR, Todd, TC, Oakley, TR, Lee, J, and Trick, HN. 2010. Host-derived suppression of nematode reproductive and fitness genes decreases fecundity of *Heterodera glycines* Ichinohe. *Planta* 232:775-785
- Mayol, PS, and Bergeson, GB. 1970. The role of secondary invaders in *Meloidogyne incognita* infection. *J. Nematol.* 2:80-83
- Patel, N, Hamamouch, N, Li, C, Hussey, R, Mitchum, M, Baum, T, Wang, X, and Davis, EL. 2008. Similarity and functional analyses of expressed parasitism genes in *Heterodera schachtii* and *Heterodera glycines*. *J. Nematol.* 40: 299-310
- Sasser, JN. 1980. Root-knot nematodes: a global menace to crop production. *Plant Dis.* 64:36-41
- Sasser, JN, Eisenback, JD, Carter, CC, and Triantaphyllou, AC. 1983. The International *Meloidogyne* project - its goals and accomplishments. *Annu Rev Phytopathol* 21:271-288
- Sundermann, CA, and Hussey, RS. 1988. Ultrastructural cytochemistry of secretory granules of esophageal glands of *Meloidogyne incognita*. *J. Nematol.* 20:141-149
- Venter, M. 2007. Synthetic promoters: genetic control through *cis* engineering. *Trends Plant Sci* 12:118-124
- Wang, XH, Replogle, A, Davis, EL, and Mitchum, MG. 2007. The tobacco Cel7 gene promoter is auxin-responsive and locally induced in nematode feeding sites of heterologous plants. *Molecular Plant Pathology* 8(4):423-436

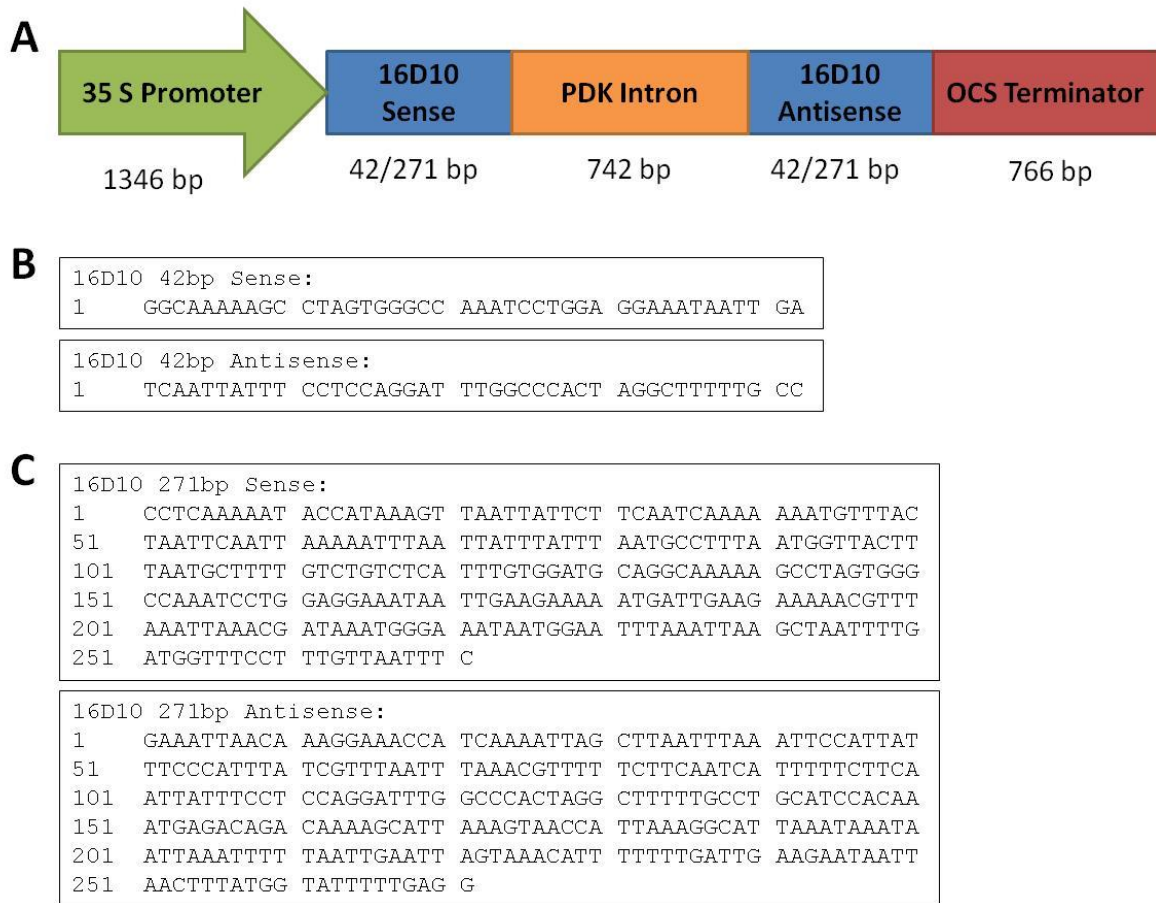
Weising, K, Schell, J, and Kahl, G. 1988. Foreign genes in plants: transfer, structure, expression, and applications. *Ann. Rev. Genet.* 22:421-477

Wesley, SV, Helliwell, CA, Smith, NA, Wang, MB, Rouse, DT, Liu, Q, Gooding, PS, Singh, SP, Abbott, D, Stoutjesdijk, PA, Robinson, SP, Gleave, AP, Green, AG, and Waterhouse, PM. 2001. Construct design for efficient, effective and high-throughput gene silencing in plants. *Plant J* 27:581–590

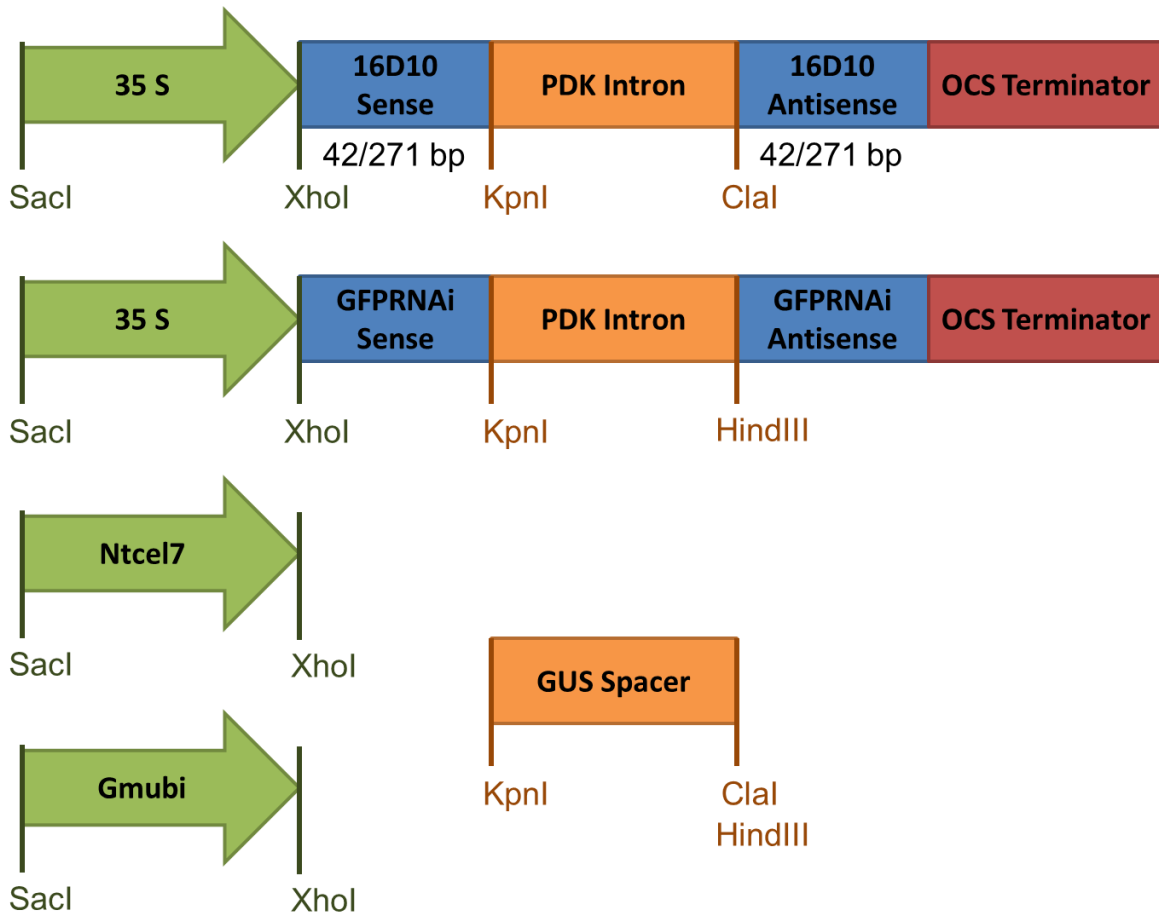
Xue, B, Hamamouch, N, Li, C, Huang, G, Hussey, RS, Baum, TJ, and Davis, EL. 2013. The 8D05 parasitism gene of *Meloidogyne incognita* is required for successful infection of host roots. *Phytopathology* 103:175-181

**Table 5. *Arabidopsis thaliana* lines produced.** Number of lines of each construct found to be resistant to kanamycin and number of lines confirmed by PCR to contain the construct are shown.

| <b>Construct</b>   | <b>Lines resistant to kanamycin</b> | <b>Lines with the full construct confirmed</b> |
|--------------------|-------------------------------------|--|
| 35S:16D10-1:PDK    | 13                                  | 10   |
| 35S:16D10-2:PDK    | 5                                   | 0  |
| 35S:GFPRNAi:PDK    | 28                                  | 6  |
| 35S:16D10-1:GUS    | 1                                   | 1  |
| 35S:16D10-2:GUS    | 13                                  | 2  |
| 35S:GFPRNAi:GUS    | >100                                | 5  |
| Ntcel7:16D10-1:PDK | 23                                  | 11   |
| Ntcel7:16D10-2:PDK | 0                                   | 0  |
| Ntcel7:GFPRNAi:PDK | 4                                   | 0  |
| Gmubi:16D10-1:PDK  | 6                                   | 2  |
| Gmubi:16D10-2:PDK  | 3                                   | 3  |
| Gmubi:GFPRNAi:PDK  | 7                                   | 3  |

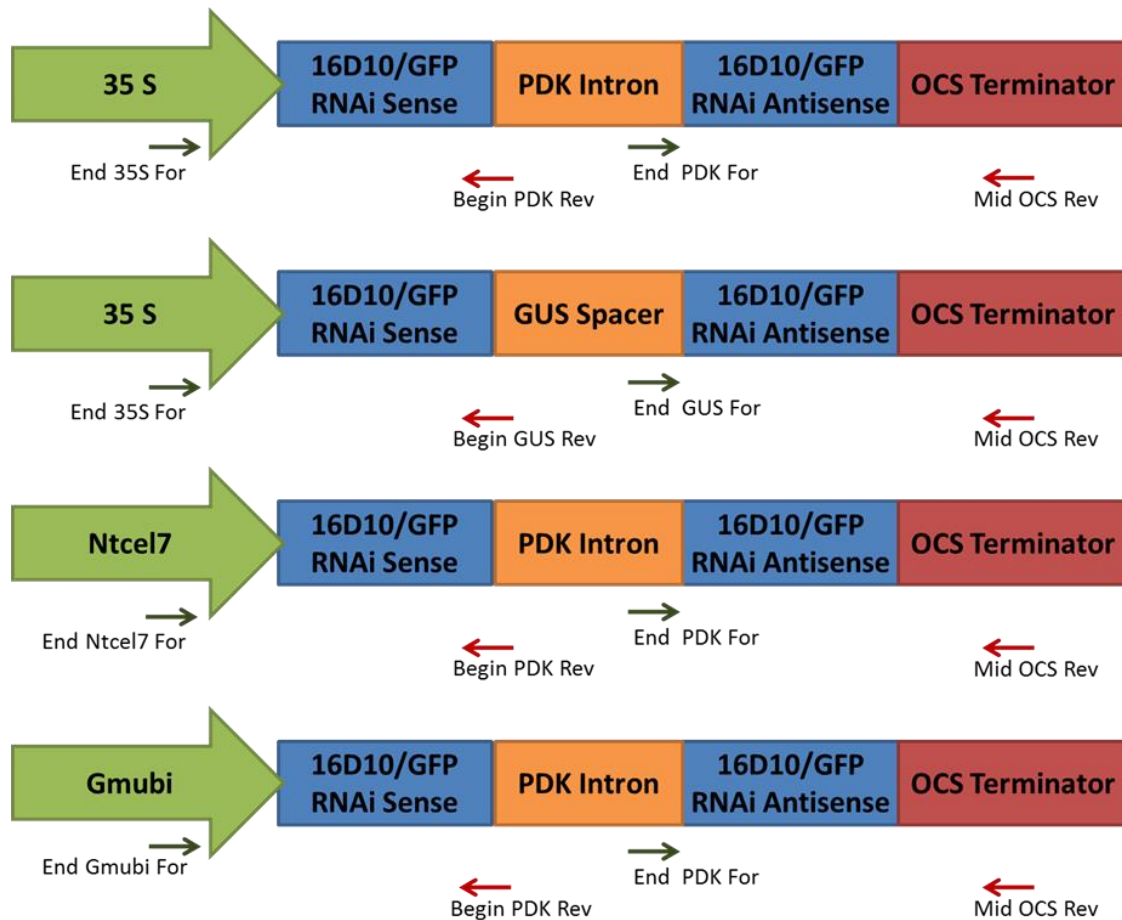


**Figure 21. Design of the transgene used for RNAi against the 16D10 gene, as designed by Huang et al. (2006, PNAS).** A. The design for the 16D10-RNAi construct used for RNA interference against the *Meloidogyne incognita* 16D10 gene. B. The 42bp sense and antisense sequences used in the 16D10-RNAi-I construct. C. The 271bp sense and antisense sequences used in the 16D10-RNAi-II construct.



**Figure 22. Design for creation of the new RNAi vectors.** The SacI and XhoI restriction enzymes as shown were used to swap the 35S promoter for either the Ntcel7 or Gmubi promoter. The KpnI and ClaI enzymes were used to swap the PDK intron with the GUS spacer in the 16D10RNAi constructs while the KpnI and HindIII enzymes were used to swap the PDK intron with the GUS spacer in the GFPRNAi construct.





Forward Primers

End 35S For: 5'-CCAACCACGTCTTCAAAGCAAGTGG-3'

End Ntcel7 For: 5'-TTGCGTTGCTGTGATTGGATTCCC-3'

End Gmubi For: 5'-GATCTGTTAGCAACTGCCTTG-3'

Reverse Primers

Begin PDK Rev: 5'-CTTCTTCGTCTTACACATCACTTGTC-3'

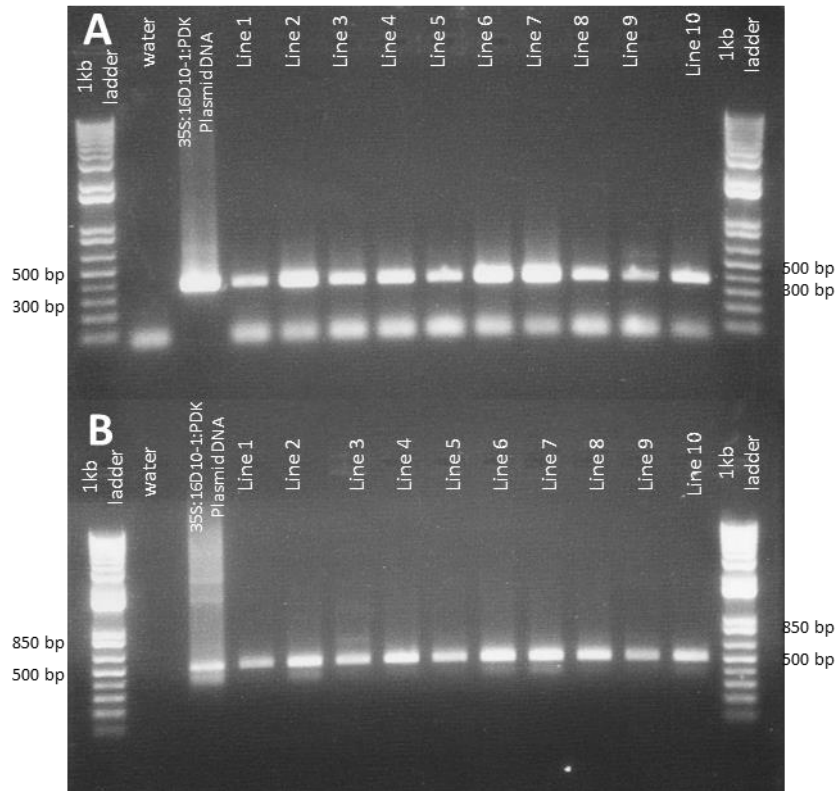
Begin GUS Rev: 5'-GCCGACAGCAGCAGTTTCATCAAT-3'

Mid OCS Rev: 5'-TTATTAGTTCGCCGCTCGGTGTGT-3'

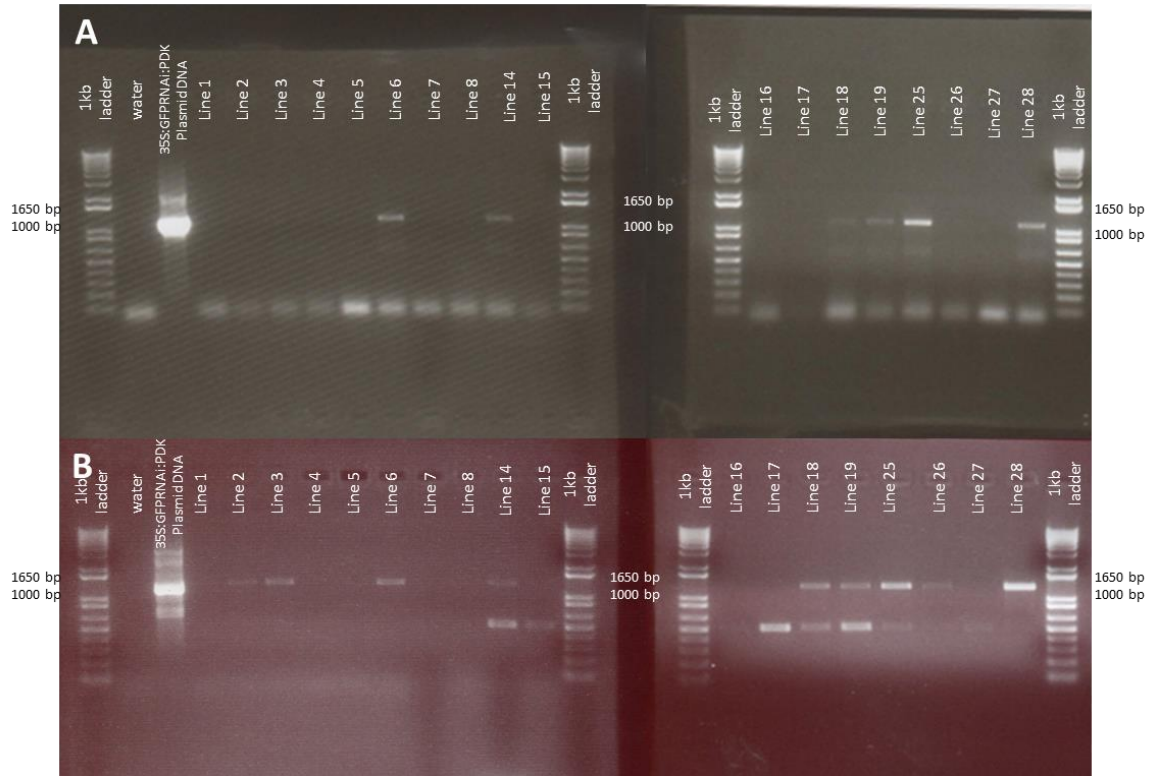
End PDK For: 5'-ACAGTTGGGAAATTGGGTTCTGA-3'

End GUS For: 5'-ATGGCTGGATATGTATCACCGCGT-3'

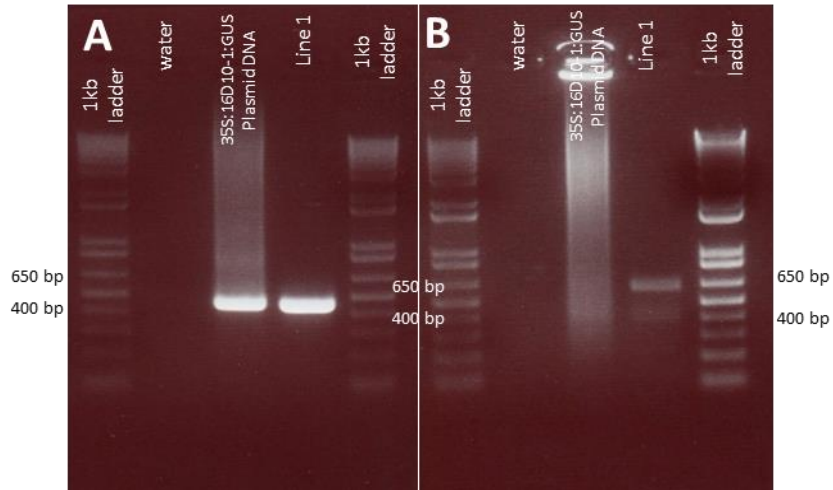
**Figure 23. PCR design and primers used to confirm the presence of the construct.** To confirm the successful insertion of the construct the PCR primers shown in the above figure were used to amplify both the front and back halves of each construct. The approximate binding position and direction is denoted with arrows. The PCR primer sequences are also shown at the bottom of the figure.



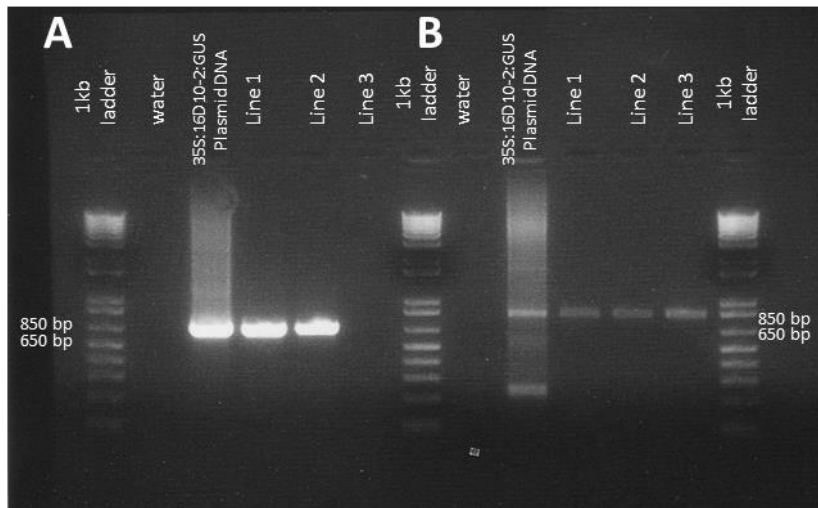
**Figure 24. PCR amplification of the 35S:16D10-1:PDK construct.** **A.** PCR of the first half of the construct, expected to be 371 bp using primers End35SFor and BeginPDKRev. **B.** PCR of the second half of the construct, expected to be 513 bp using primers EndPDKFor and midOCSRev.



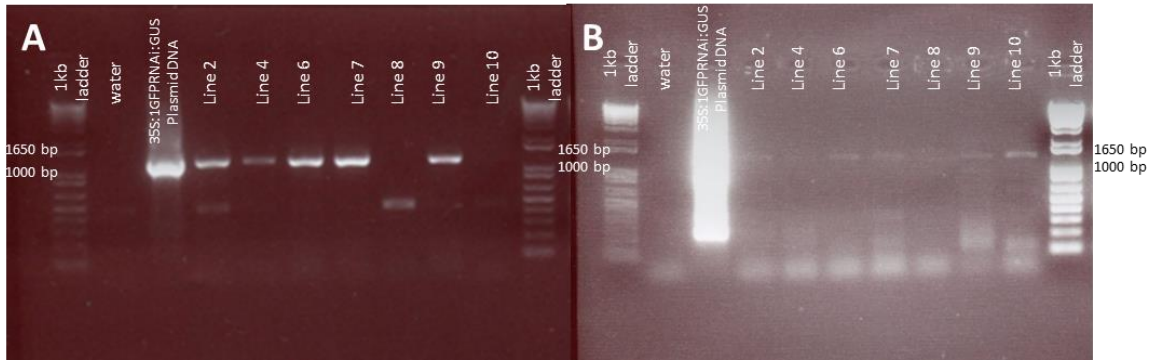
**Figure 25. PCR amplification of the 35S:GFPRNAi:PKD construct. A.** PCR of the first half of the construct, expected to be 1122 bp using primers End35SFor and BeginPDKRev. **B.** PCR of the second half of the construct, expected to be 1323 bp using primers EndPDKFor and midOCSRev



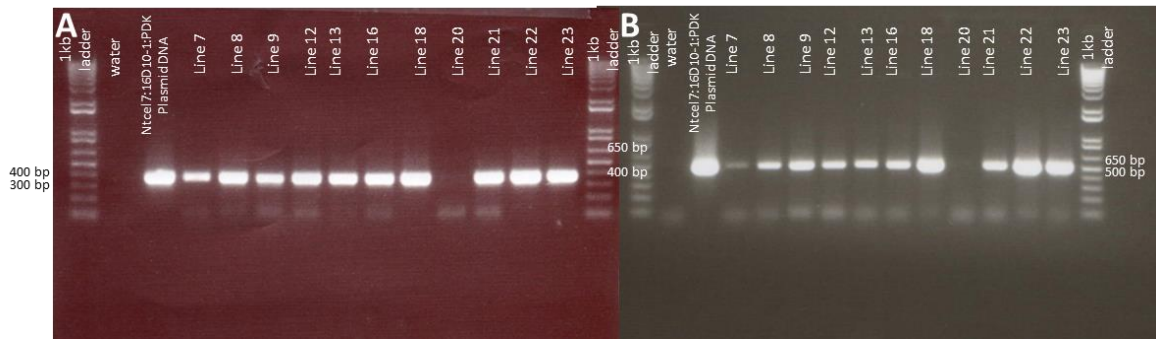
**Figure 26. PCR amplification of the 35S:16D10-1:GUS construct.** **A.** PCR of the first half of the construct, expected to be 464 bp using primers End35SFor and BeginGUSRev. **B.** PCR of the second half of the construct, expected to be 625 bp using primers EndGUSFor and midOCSRev.



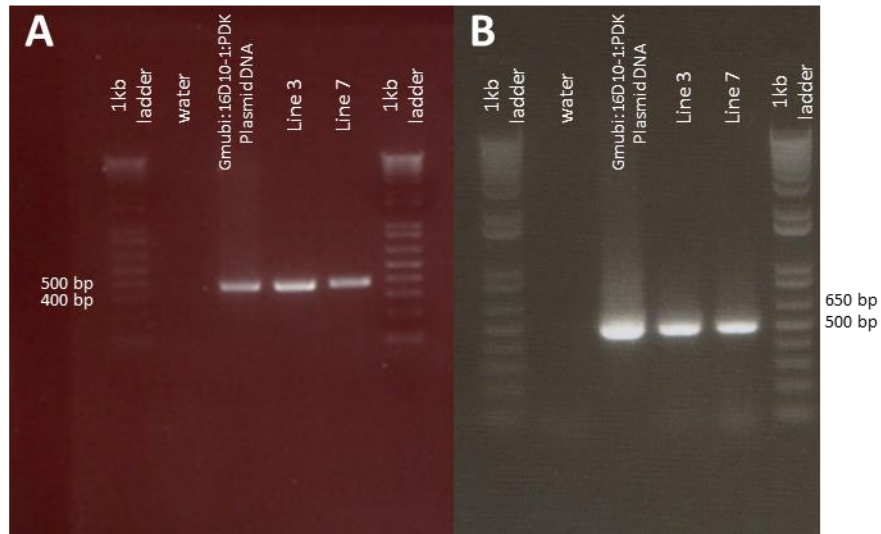
**Figure 27. PCR amplification of the 35S:16D10-2:GUS PCR construct.** **A.** PCR of the first half of the construct, expected to be 692 bp using primers End35SFor and BeginGUSRev. **B.** PCR of the second half of the construct, expected to be 854 bp using primers EndGUSFor and midOCSRev.



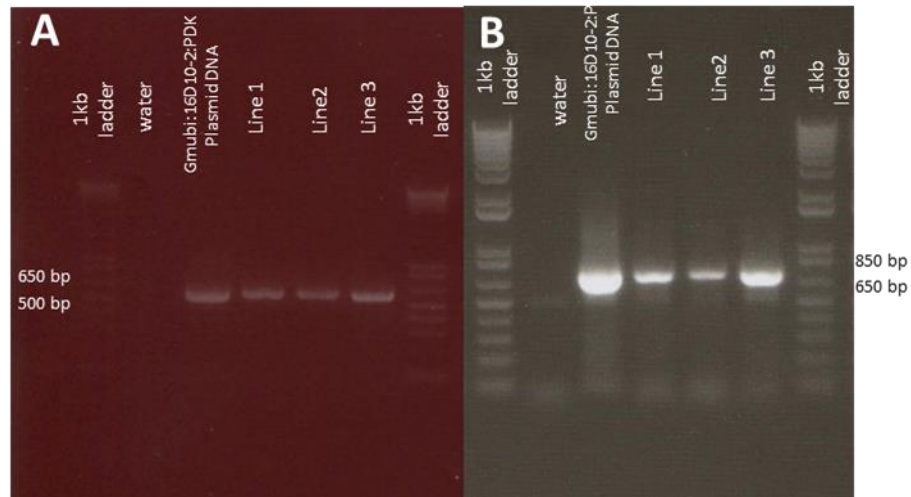
**Figure 28. PCR amplification of the 35S:IGFPRNAi:GUS construct. A.** PCR of the first half of the construct, expected to be 1214 bp using primers End35SFor and BeginGUSRev. **B.** PCR of the second half of the construct, expected to be 1429 bp using primers EndGUSFor and midOCSRev.



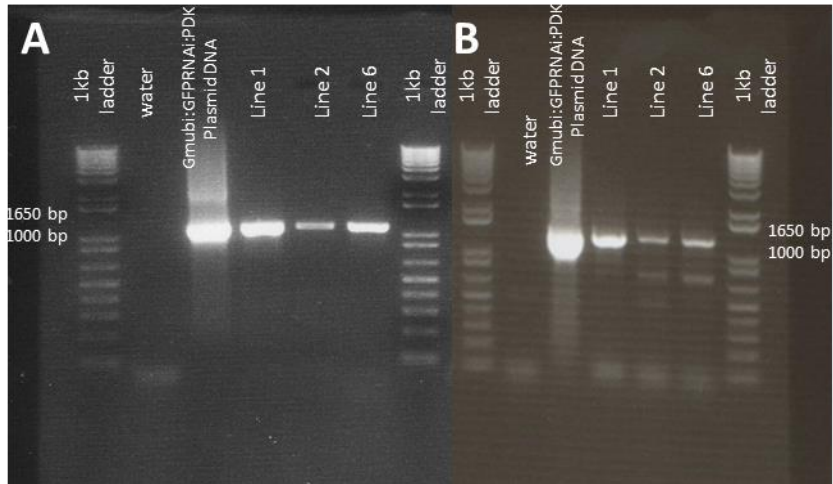
**Figure 29. PCR amplification of the Ntcel7:16D10-1:PDK construct. A.** PCR of the first half of the construct, expected to be 368 bp using primers EndNtcel7For and BeginPDKRev. **B.** PCR of the second half of the construct, expected to be 513 bp using primers EndPDKFor and midOCSRev.



**Figure 30. PCR amplification of the Gmubi:16D10-1:PDK construct.** **A.** PCR of the first half of the construct, expected to be 383 bp using primers EndGmubiFor and BeginPDKRev. **B.** PCR of the second half of the construct, expected to be 513 bp using primers EndPDKFor and midOCSRev.



**Figure 31. PCR amplification of the Gmubi:16D10-2:PDK construct.** **A.** PCR of the first half of the construct, expected to be 611 bp using primers EndGmubiFor and BeginPDKRev. **B.** PCR of the second half of the construct, expected to be 742 bp using primers EndPDKFor and midOCSRev.



**Figure 32. PCR amplification of the Gmubi:GFPRNAi:PDK construct.** **A.** PCR of the first half of the construct, expected to be 1134 bp using primers EndGmubiFor and BeginPDKRev. **B.** PCR of the second half of the construct, expected to be 1323 bp using primers EndPDKFor and midOCSRev.

## STRAWBERRY TRANSFORMATION WITH 16D10RNAi CONSTRUCTS

### Abstract

Root-knot nematodes are sedentary plant parasitic nematodes that infect a wide range of crop species, including strawberry, and are members of the genus *Meloidogyne*.

*Meloidogyne hapla*, the Northern root-knot nematode, is the most economically damaging root-knot nematode species to infect strawberry. Root-knot nematodes infect near the root tip and migrate to the root vascular bundles where they transform selected vascular parenchyma cells into a feeding site composed of large multinucleate plant cells, or giant-cells. Root-knot nematodes modify these cells by secreting effector proteins from their esophageal gland cells into the plant cells. One novel secreted effector, 16D10, was identified by Huang et al., and overexpression of 16D10 in *Arabidopsis thaliana* resulted in transgenic plants with significantly increased root lengths due to increased root cell division. When RNAi constructs targeting the *16D10* gene were expressed in *Arabidopsis thaliana*, the transgenic plants were shown to have significantly fewer galls and nematode eggs. The objective of this research was to transform the strawberry cultivar Chandler with Huang et al.'s 16D10 constructs in an effort to create transgenic strawberries with resistance to root-knot nematode. While several researchers have successfully transformed strawberries, strawberry transformation of greenhouse-grown tissue is difficult. The research described here addresses some of the challenges with producing transgenic strawberries, including explant browning due to production of phenols in tissue culture.



## Introduction

Root-knot nematodes are economically important plant parasitic nematodes, with estimates of annual worldwide crop losses at 10 billion dollars (Chitwood, 2003). These microscopic roundworms are members of the genus *Meloidogyne*, and have wide host ranges, parasitizing more than 2,000 plant species, including strawberry (Sasser, 1980). There are more than 70 described species of *Meloidogyne*, and the most economically damaging species to strawberry is *Meloidogyne hapla*, the Northern root-knot nematode (Goheen and Bailey, 1955, LaMondia, 1999). Koenning et al. (1999) estimated that Louisiana strawberry growers lost around 7.2 million dollars in 1994 due to infections by *M. hapla* and other plant nematodes, particularly *Pratylenchus spp.*

The life cycle of the root-knot nematode begins with the hatching of second-stage juveniles (J2) from eggs (Literature Review, Figure 1). These second-stage juveniles penetrate roots and move intercellularly to the root vascular bundles where they transform selected vascular parenchyma cells into a complex feeding site to sustain the subsequent sedentary parasitic stages of the nematode to reproductive maturity. These feeding sites are composed of several giant-cells, large multinucleate hypertrophic plant cells that arise from karyokinesis without cytokinesis and have been modified by nematode secreted proteins (Davis et al., 2004; Huang, 1985; Hussey, 1985). Galls are formed on the roots as localized hyperplasia of the cells surrounding the giant-cells occurs. The root-knot nematode infection sites serve as nutrient sinks that can cause plant stunting, wilting, and reduced yields, and that can predispose the roots to secondary infections. Root-knot nematodes penetrate the cell wall with their stylet (hollow oral spear) and secrete effector proteins from their esophageal

gland cells into the plant cell (Bird and Saurer, 1967; Bird, 1968; Sundermann and Hussey, 1988). These secreted effector proteins are thought to be involved in giant cell formation (Hussey, 1989; Davis et al., 2004).

In order to identify the parasitism genes (Davis et al., 2000) that encode the effector proteins secreted by root-knot nematodes, Huang et al. (2003) microaspirated the gland cells of 10 different stages of root-knot nematode and created gland cell cDNA libraries. After EST analysis, 37 putative parasitism genes that were uniquely expressed in the gland cells and contained signal peptides for secretion as determined by SignalP analyses (Nielsen et al., 1997) were identified. One of these parasitism genes, *16D10*, was expressed specifically within the subventral gland cells of infective J2 and subsequent parasitic stages (Huang et al., 2003). The *16D10* gene (GenBank accession no. AY134435) encoded a small peptide, 13aa in length, less than half the size of its secretion signal peptide (30 aa), and the peptide had no significant database homolog. *16D10* was found to be conserved in all four major species of root-knot nematode (Huang et al., 2006a), but absent from two species of other nematode genera, *Heterodera glycines* and *Caenorhabditis elegans*, using a southern blot. The *16D10* gene was also not detected in *Nicotiana tabacum* or *Arabidopsis thaliana* (Huang et al., 2006a). To analyze the function, Huang et al. (2006a) overexpressed the 16D10 protein in *Arabidopsis thaliana*, and the resulting transgenic plants had significantly increased root lengths due to increased root cell division. Yeast-two-hybrid assays (Huang et al., 2006a) demonstrated that 16D10 interacts with the SAW domain of plant SCARECROW-like transcription factors (Di Laurenzio et al., 1996). This led to the conclusion that the *16D10*

gene might function as a regulator of feeding cell differentiation via the SCL pathway (Huang et al., 2006a).

In order to test the importance of 16D10 in giant-cell formation, Huang et al. (2006b) used RNA interference (RNAi) to knock down root-knot nematode *16D10* gene expression by delivering the siRNA using a host plant. *Arabidopsis thaliana* plants were stably transformed with one of two different *16D10* dsRNA hairpin constructs, which were made using the pHANNIBAL vector (Wesley et al., 2001). This vector uses the CaMV 35S promoter and the PDK intron as a spacer between the sense and antisense coding sequences of the target gene (*16D10*) hairpin double-stranded RNA (dsRNA). Each vector was modified to contain either 42bp or 271 bp of *16D10* sense coding sequence as well as the corresponding antisense *16D10* sequence. Root-knot nematode infection assays of *Arabidopsis* plants transformed with the pHANNIBAL::16D10RNAi constructs were shown to have significantly fewer galls (63-90% reduction) and eggs (69-93% reduction) than *Arabidopsis* transformed with an empty vector control (Huang et al., 2006b).

As stated previously, *Meloidogyne sp.* are capable of parasitizing strawberries and cause significant losses to farmers. In the past methyl bromide was commonly used on strawberries to control nematodes and other pathogens (Thomas, 1996). The discovery of the role of methyl bromide in ozone depletion and the discovery of similar environmental issues with other pesticides have led to restrictions in nematicide use. While natural sources of resistance to *M. hapla* are available in strawberry (Pinkerton and Finn, 2005), alternative methods of obtaining resistance to root-knot nematodes are useful considering the ability of pathogens including root-knot nematode species to overcome resistance genes (Pinkerton and

Finn, 2005; Castagnone-Sereno, 2002). A new control method is the delivery of RNAi targeted to nematode genes by host plants in order to create resistance in the host. Unfortunately while several researchers have successfully transformed strawberries, strawberry transformation of greenhouse- grown tissue is still quite difficult (Folta and Dhingra, 2006; Barcelo et al., 1998). The research detailed below addresses some of the challenges with producing transgenic strawberries expressing the 16D10RNAi constructs created by Huang et al. (2006b).

## **Materials and Methods**

### Tissue Source and Tissue Sterilization

Leaf tissue of *Fragaria X ananassa* 'Chandler' was obtained from the North Carolina State University Micropropagation and Repository Unit. The leaf tissue was taken from virus-free plants grown in the greenhouse. Whole leaves were surface sterilized by submersion in 70% ethanol for 1 minute followed by submersion in 20% bleach for 8 minutes. Tissue was then rinsed with sterilized water three times and leaf disks were created by cutting the tissue into squares of approximately 5mm x 5mm with sterile scissors.

### RNAi Vectors

The two *16D10*-RNAi vectors used by Huang et al. (2006b) were obtained from Dr. Richard Hussey at the University of Georgia and contained the pHANNIBAL:16D10RNAi-1 and pHANNIBAL:16D10RNAi-2 constructs, both in the pART27 binary vector (Gleave,

1992). These vectors were both transformed into ElectroMAX™ *Agrobacterium tumefaciens* LBA4404 (Invitrogen) using electroporation (2.0kV, 200Ω, 25μF).

#### Preparation of Agrobacteria

*Agrobacterium tumefaciens* was grown in 50ml of LB spectinomycin 100mg/L, gentamycin 50mg/L broth for 16-20 hours at 28°C while shaking at 225rpm. Cultures were transferred to sterile 50ml centrifuge tubes and centrifuged at 3000rpm for 30 minutes. Pellets were re-suspended in 25mL of MS basal medium and grown for 2 hours at 28°C while shaking at 225rpm. Cultures were then either diluted or concentrated with MS basal medium to obtain an optical density 600nm reading of 0.8-1.0 ( $4 \times 10^8$ - $5 \times 10^8$  cells/ml).

#### Strawberry Transformation Method 1

Transformation of the leaf disks was performed following the protocol used by Barcelo et al. (1998), with the main change being the use of leaf disks directly from virus-free greenhouse-grown leaf tissue, and the use of timentin to kill the agrobacteria instead of carbenicillin. Sterile leaf disks to be transformed were submerged in the cultures of *Agrobacterium tumefaciens* in the MS basal medium while wild-type controls were submerged in approximately 50 ml of MS basal medium with no agrobacteria. Leaf tissue was incubated in a solution of *Agrobacterium* with gentle rotation for 20 minutes, then drained and plated on strawberry regeneration medium (Barcelo et al., 1998). Strawberry tissue was allowed to co-cultivate with *Agrobacterium* for 3 days in the dark at 25°C, and the tissue was then transferred to strawberry selection medium (same as strawberry regeneration medium except with the addition of 50mg/ml kanamycin and 300mg/ml timentin) and placed

in the dark at 25°C for an additional 11 days. As a positive control 2 plates of wild-type tissue and 1 plate of transformed tissue were plated on fresh strawberry regeneration medium instead of selection medium, and were also placed back in the dark at 25°C for another 11 days. Plates of tissue were then moved to a lighted growth chamber at 25°C to await callus tissue growth.

#### Strawberry Transformation Method 2

The second method was performed exactly as the first except that, prior to transformation, sterile leaf disks were rinsed with MS basal medium 3 times, then transformed as before.

#### Strawberry Transformation Method 3

Strawberry tissue was transformed as in method 2 except that after transformation the tissue was re-plated on new medium every day for at least 2 weeks. During the daily phase of incubation in the dark the tissue was re-plated on strawberry transformation medium; after it was moved to the growth chamber it was re-plated on strawberry selection medium.

#### Strawberry Transformation Method 4

Strawberry tissue was transformed as in method 2 except that after co-cultivation the leaf disks were plated on strawberry transformation medium with 5g/L activated charcoal added, then transferred to strawberry selection medium with 5g/L activated charcoal.

### Strawberry Transformation Method 5

Strawberry tissue was transformed and handled as in method 4 except that after one week on the activated charcoal selection medium they were re-plated on strawberry selection medium without activated charcoal.

### **Results**

After 3 to 5 days all strawberry tissue transformed with method 1 turned brown and died. This included the positive controls that were never exposed to antibiotic selection. It was noted that during the co-cultivation step the originally clear MS basal medium had turned dark purple by the end of the 20 minute incubation (Figure 33A). This result, combined with the characteristic explant browning of the tissue after plating (Huang et al., 2002; Murata et al., 2001), indicated a high release of phenolic compounds from the strawberry tissue as a response to the injury from the process of sterilizing and cutting the leaf tissue. It was also noted that after the 3 days in the dark, a dark purple ring was clearly visible in the medium around each explant where the phenols had been released into the medium. Since high levels of phenols were likely responsible for the death of the explants, method 2 was devised, in which the tissue was rinsed with MS basal medium 3 times in order to decrease the concentration of phenols during the co-cultivation step. This did result in the MS basal medium remaining clear instead of turning purple (Figure 33B), and increased the strawberry leaf disk survival by a few days, but the purple phenolic ring in the medium around the explants during the recovery step was still visible and none of the explants (again including the positive controls) survived past 14 days, and none produced callus tissue. The next

change in the protocol was to re-plate the explants onto fresh medium daily, in an effort to reduce their exposure to the phenols they released into the medium. Frequent subculturing is known to help reduce phenolic oxidation and improve tissue regeneration (Ozyigit, 2007). Method 3 increased survival by several days but was time consuming and again the tissue did not survive to produce callus. Method 4 was devised and activated charcoal was added to the strawberry transformation medium, since activated charcoal is known to absorb phenols (Thomas, 2008). This method resulted in the greatest survival rate (Figure 34). After 3 weeks tissue from the positive controls as well as some of the tissue that had been transformed and plated on selection medium was alive, while the wild-type tissue plated on selection medium without activated charcoal (the negative control) had all died (as in methods 1 to 3 above). Unfortunately, little callus tissue ever formed (Figure 34) on the surviving leaf tissue using method 4. Since activated charcoal is capable of absorbing plant hormones and nutrients (Thomas, 2008; Nguyen et al., 2007; Huong et al., 1999) it was determined that the charcoal might be impeding the induction of callus tissue formation. Method 5 was then devised, which was exactly like method 4 except the surviving strawberry tissue was transferred to selection medium without charcoal after one week with charcoal. This method resulted in greater production of callus tissue in some of the positive controls and some of the transformants on selection medium, but the callus remained small and no shoots regenerated from the callus.



## Discussion

Strawberry plants are known to secrete phenolic compounds in response to injury, and this secretion of phenolics can cause problems for tissue culture systems (Thomas, 2008). Barcelo et al. (1998) successfully combated this problem by including an incubation in the dark after transformation. While the same period in the dark was used in this experiment, phenolic expression was still high and resulted in the death of the strawberry tissue used in this experiment after 3 to 5 days, meaning that some of the tissue did not even survive to be transferred to selection medium. Also all of the positive controls that were never plated on selection medium all died as well, indicating the phenolic compounds were likely responsible for the tissue death instead of the antibiotics in the selection medium. The main change between the Barcelo et al. (1998) method and the method used in this experiment was the use of leaf tissue taken directly from greenhouse plants instead of *in vitro*-grown tissue. Since the greenhouse is a more stress-inducing environment than a tissue culture system, most likely plants grown in the greenhouse would produce a higher concentration of phenolic compounds than those grown in tissue culture (Folta and Dhingra, 2007). Unfortunately there was not sufficient *in vitro*-grown tissue available for use in this experiment. For this reason alterations were made to the method of transformation in order to reduce the phenolic compounds. The first alteration was adding a washing step after tissue sterilization and leaf cutting but before the incubation with *Agrobacterium*. The hypothesis was that rinsing after injury would remove the highest concentrations of phenols and allow the strawberry tissue to survive the transformation process. Also, a previous study by Oosumi et al. (2006) utilized a similar washing step after sterilization and was able to

produce transgenic strawberries. The washing step did reduce the exposure of the tissue to the initial high expression of phenolic compounds, as can be seen from the loss of purple color from the liquid MS basal medium at the end of the incubation with *Agrobacterium* (Figure 33). Also this change did result in greater survival of the tissue, which had previously died after 3 to 5 days. After the addition of the washing step most of the tissue survived the first week but died after 14 days. Since the washing step was an improvement it was kept as part of the protocol for all subsequent transformation methods. The next change in the protocol was an attempt to target the phenolic compounds that were released by the strawberry tissue into the strawberry regeneration medium, resulting in the dark purple ring in the medium surrounding the explants. Since a washing step had resulted in an increase in survival it was speculated that the washing step along with daily tissue transfers to fresh medium would sufficiently reduce the tissue's exposure to the phenolic compounds and allow the tissue to survive. This method again resulted in a longer survival period and most of tissue from the positive controls and some transformed tissue plated on selection medium survived 14 days. Also the ring of phenolic compounds around the explants was much lighter, although it was still present even after a week of daily re-plating. While this method was an improvement over the previous protocols, it was time consuming and all of the tissue still died before the end of 3 weeks.

Previous studies involving tissue culture of many different species of plants, including strawberry, have had similar problems with phenolic compounds. One way to combat this problem is the use of activated charcoal (Thomas, 2008; Jemmali et al., 2002). The concentration of activated charcoal used in tissue culture medium varies greatly among

studies, ranging from 0.01 to 5g/L (Thomas, 2008). For this study a concentration of 5g/L was used to test if a high concentration of activated charcoal would be sufficient to absorb the phenols and protect the strawberry tissue (Figure 34A). While this concentration was effective for phenol absorption, it also resulted in little callus tissue formation (Figure 34B & C). Previous studies have shown that activated charcoal will also absorb the nutrients and phytohormones in the tissue culture medium that the plant tissue needs to produce callus (Nguyen et al., 2007; Huong et al., 1999). In order to fix this problem the surviving strawberry tissue was transferred to selection medium without the charcoal after one week on the strawberry selection medium with charcoal. The rationale behind this alteration was that one week would be long enough for the strawberry tissue to recover from the sterilization and transformation and the strawberry tissue would stop producing phenols. Once phenol production ceased the tissue could be transferred to selection medium without the charcoal which would have the right hormone and nutrient concentration for callus tissue formation. While this method did result in the greater production of callus tissue, no shoots ever formed from the callus.

There are several changes that could be made to the protocol that might allow for the successful production of strawberry callus tissue. The first is altering the concentration of activated charcoal used in the regeneration/selection medium. While a concentration of 5g/L was successfully used to produce bulblets in garlic, *Allium sativum* (Mohamed-Yasseen et al., 1993), Nguyen et al. (2007) found that, in sorghum, as the concentration of activated charcoal increased the amount of callus produced by transformed tissue decreased. In the study of Nguyen et al. (2007), concentrations of 1, 2, 3, 4, and 5g/L of activated charcoal

were used, all of which increased explant survival, from 30% in the absence of activated charcoal to 80% for the concentrations tested. However callus formation on the surviving tissue was reduced from around 91% for the control to only 66% for the 1g/L concentration and only 35, 13, 14, and 5% for the 2, 3, 4, and 5g/L concentrations respectively (Nguyen et al., 2007). Also a previous study by Jemmali et al., (2002) successfully rooted strawberry in 0.5g/L activated charcoal. Based on the data from these studies it is clear that a lower concentration of activated charcoal should be tested to see if a concentration that results in tissue survival and callus formation can be achieved. Another possible change to the medium would be to increase the concentration of plant hormones and nutrients so that more would be available to the tissue. A study by Ebert and Taylor (1990) showed that increasing the concentration of 2, 4-dichlorophenoxyacetic acid along with reducing the activated charcoal concentration increased the levels of 2, 4-dichlorophenoxyacetic acid available for the tissue. A later study showed the similar results with 6-benzyl aminopurine (Ebert et al., 1993). Determining the best concentrations of activated charcoal as well as the concentration of the hormones and nutrients to produce transformed strawberry regenerate plants from greenhouse tissue would require considerable empirical testing.

Another solution may be to use *in vitro*-grown tissue instead of greenhouse tissue. While sufficient *in vitro*-grown tissue was not available for this study, many other researchers have successfully used *in vitro*-grown tissue as a tissue source for transformation (Folta and Dhingra, 2006). Several of experiments have used leaf tissue from plants already in tissue culture, and this method has resulted in successful transformants (Folta and Dhingra, 2006). This research was unsuccessful in its attempt to transform and regenerate strawberry,

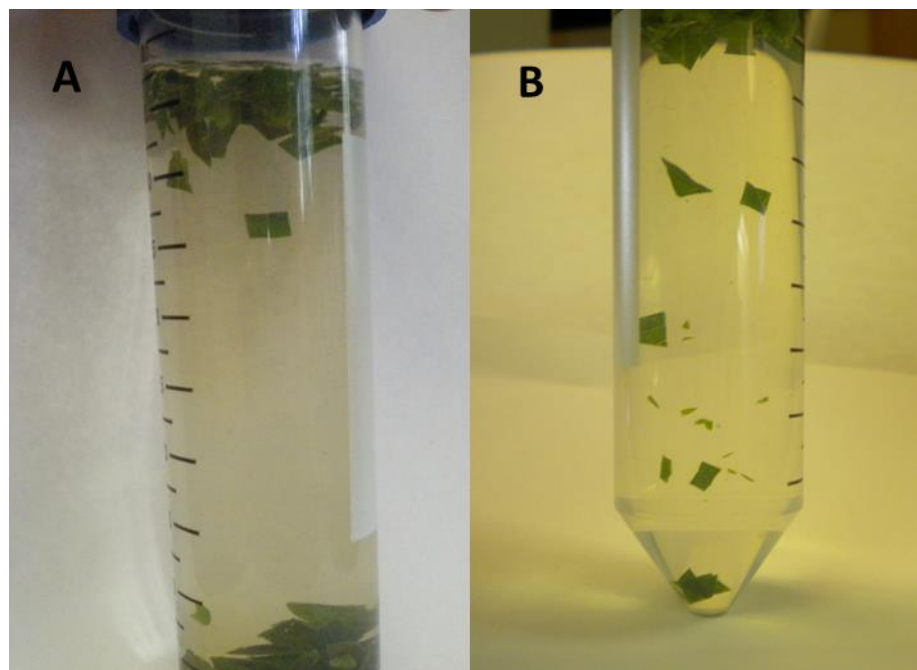
but there are many possible solutions to this problem. Once a more robust strawberry transformation and regeneration system is developed, producing transgenic strawberry with desired traits such as RNAi-based resistance to root-knot nematodes may be achieved.

## References

- Barcelo, M, El-Mansouri, I, Mercado, JA, Quesada, MA, and Alfaro, FP. 1998. Regeneration and transformation via *Agrobacterium tumefaciens* of the strawberry cultivar Chandler. *Plant Cell Tiss. Organ Cult.* 54:29–36
- Bird, AF, and Saurer, W. 1967. Changes associated with parasitism in nematodes. II. Histochemical and microspectrophotometric analyses of preparasitic and parasitic larvae of *Meloidogyne javanica*. *Journal of Parasitology* 53:1262-1269
- Bird, AF. 1968. Changes associated with parasitism in nematodes. IV. Cytochemical studies on the ampulla of the dorsal esophageal gland of *Meloidogyne javanica* and on exudations from the buccal stylet. *J. Parasitol.* 54:879-890
- Castagnone-Sereno, P. 2002. Genetic variability of nematodes: a threat to the durability of plant resistance genes? *Euphytica* 124:193–199
- Davis, EL, Hussey, RS, and Baum, TJ. 2004. Getting to the roots of parasitism by nematodes. *Trends Parasitol.* 20:134-141
- Di Laurenzio, L, WysockaDiller, J, Malamy, JE, Pysh, L, Helariutta, Y, Freshour, G, Hahn, MG, Feldmann, KA, and Benfey, PN. 1996. The *SCARECROW* gene regulates an asymmetric cell division that is essential for generating the radial organization of the *Arabidopsis* root. *Cell* 86:423–433
- Ebert, A, and Taylor, HF. 1990. Assessment of the changes of 2, 4-dichlorophenoxyacetic acid concentrations in plant tissue culture media in the presence of activated charcoal. *Plant Cell Tissue Organ Cult* 20:165–172
- Ebert, A, Taylor, F, and Blake, J. 1993. Changes of 6-benzylaminopurine and 2, 4-dichlorophenoxyacetic acid concentrations in plant tissue culture media in the presence of activated charcoal. *Plant Cell Tissue Organ Cult* 33:157–163
- Folta, KM, and Dhingra, A. 2006. Transformation of strawberry: the basis for translational genomics in rosaceae. *In Vitro Cell Dev Biol Plant* 42:482–490

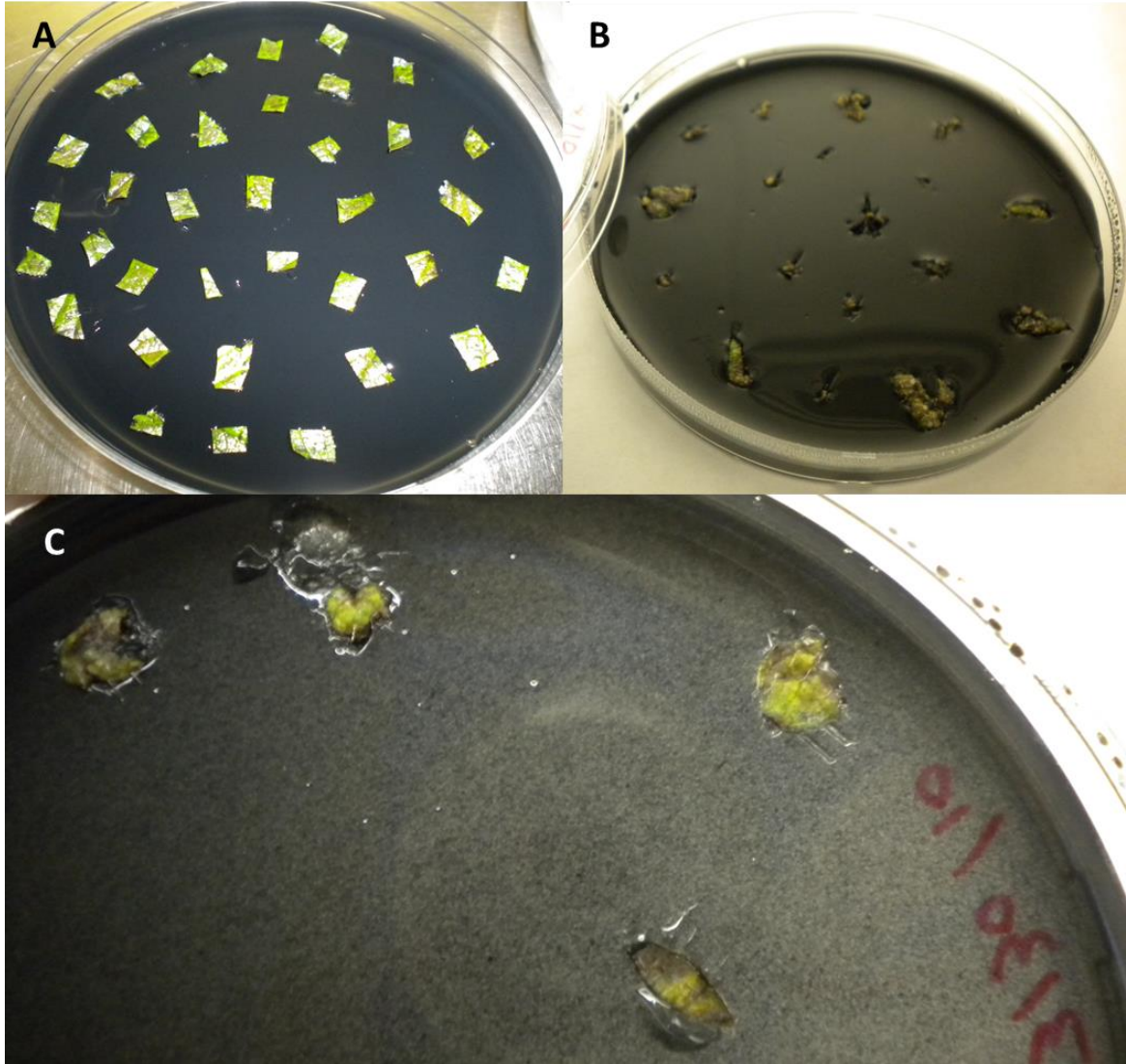
- Gleave, AP. 1992. A versatile binary vector system with a T-DNA organisational structure conducive to efficient integration of cloned DNA into the plant genome. *Plant Molecular Biology* 20:1203–1207
- Goheen, AC, and Bailey, JS. 1955. Meadow nematodes in strawberry plantings in Massachusetts. *Plant Disease Reporter* 39:879–880
- Huang, CS. 1985. Formation, anatomy, and physiology of giant cells induced by root-knot nematodes. In: Sasser, JN, and Carter, CC. (eds.). An advanced treatise on *Meloidogyne*, vol 1, biology and control. North Carolina State University Graphics, Raleigh, NC, pp. 155-164
- Huang, GZ, Gao, B, Maier, T, Allen, R, Davis, EL, Baum, TJ, and Hussey, RS. 2003. A profile of putative parasitism genes expressed in the esophageal gland cells of the root-knot nematode *Meloidogyne incognita*. *Mol. Plant-Microbe Interact.* 16:376-381
- Huang, GZ, Dong, R, Allen, R, Davis, EL, Baum, TJ, and Hussey, RS. 2006. A root-knot nematode secretory peptide functions as a ligand for a plant transcription factor. *Mol. Plant-Microbe Interact* 19:463–470
- Huang, GZ, Allen, R, Davis, EL, Baum, TJ, and Hussey, RS. 2006. Engineering broad root-knot resistance in transgenic plants by RNAi silencing of a conserved and essential root-knot nematode parasitism gene. *Proc. Natl. Acad. Sci. USA* 103(39):14302-14306
- Huang, LC, Lee, YL, Huang, BL, Kuo, CI, and Shaw, JF. 2002. High polyphenol oxidase activity and low titratable acidity in browning bamboo tissue culture. *In Vitro Cell Dev. Biol.-Plant* 38:358–365
- Huong, LTL, Baiocco, M, Huy, BP, Mezzetti, B, Santilocchi, R, and Rosati, P. 1999. Somatic embryogenesis in Canary Island date palm. *Plant Cell Tissue Organ Cult* 56:1–7
- Hussey, RS. 1985. Host-parasite relationships and associated physiological changes. In: Sasser, JN, and Carter, CC (eds). An advanced treatise on *Meloidogyne*, vol I, biology and control. North Carolina State University Graphics, Raleigh, NC, pp. 143-153
- Hussey, RS. 1989. Disease-inducing secretions of plant-parasitic nematodes. *Annu. Rev. Phytopathol.* 27:123-141
- Jemmali, A, Elloumi, N, Kevers, C, and Dommes, J. 2002. Morphological and hormonal characterization of strawberry vitro plants raised through axillary or stipular adventitious shooting. *Plant Growth Regul* 38:273–278
- Koenning, SR, Overstreet, C, Noling, JW, Donald, PA, Becker, JO, and Fortnum, BA. 1999. Survey of crop losses in response to phytoparasitic nematodes in the United States for 1994. *Supplement to the J. Nematol.* 31(4S):587-618

- LaMondia, JA. 1999. The effects of rotation crops on the strawberry pathogens *Pratylenchus penetrans*, *Meloidogyne hapla*, and *Rhizoctonia fragariae*. *J. Nematol.* 31:650–655
- Murata, M, Nishimura, M, Murai, N, Haruta, M, Homma, S, and Itoh, Y. 2001. A transgenic apple callus showing reduced polyphenol oxidase activity and low browning potential. *Biosci. Biotechnol. Biochem.* 65:383-388
- Mohamed-Yasseen, Y, Splittstoesser, WE, and Litz, RE. 1993. In vitro shoot proliferation and production of sets from garlic and shallot. *Plant Cell Tissue Organ Cult* 36:243–247
- Nielsen, H, Engelbrecht, J, Brunak, S, and von Heijne, G. 1997. Identification of prokaryotic and eukaryotic signal peptides and prediction of their cleavage sites. *Protein Eng.* 10:1-6
- Nguyen, TV, Thu, TT, Claeys, M, and Angenon, G. 2007. *Agrobacterium* mediated transformation of sorghum (*Sorghum bicolor* (L.) Moench) using an improved in vitro regeneration system. *Plant Cell Tissue Organ Cult* 91:155–164
- Oosumi, T, Hope, A, Gruszewski, LA, Blischak, AJ, Baxter, PA, Wadl, JL, Shuman, RE, and Veilleux, VS. 2006. High-efficiency transformation of the diploid strawberry (*Fragaria vesca*) for functional genomics. *Planta* 223: 1219–1230
- Ozyigit, II, Kahraman, MV, and Ercan, O. 2007. Relation between explant age, total phenols and regeneration response in tissue cultured cotton (*Gossypium hirsutum* L.). *Afr J Biotechnol* 6:3–8
- Pinkerton, J, and Finn, CE. 2005. Responses of strawberry species and cultivars to the root-lesion and northern root-knot nematodes. *Hort-Science* 40:33–38
- Sasser, JN. 1980. Root-knot nematodes: a global menace to crop production. *Plant Dis.* 64:36-41
- Sundermann, CA, and Hussey, RS. 1988. Ultrastructural cytochemistry of secretory granules of esophageal glands of *Meloidogyne incognita*. *J. Nematol.* 20:141-149
- Thomas, TD. 2008. The role of activated charcoal in plant tissue culture. *Biotechnol Adv* 26:618–631
- Thomas, WB. 1996. Methyl bromide: Effective pest management tool and environmental threat. *J. Nematol.* 28:586-589
- Wesley, SV, Helliwell, CA, Smith, NA, Wang, MB, Rouse, DT, Liu, Q, Gooding, PS, Singh, SP, Abbott, D, Stoutjesdijk, PA, Robinson, SP, Gleave, AP, Green, AG, and Waterhouse, PM. 2001. Construct design for efficient, effective and high-throughput gene silencing in plants. *Plant J* 27:581–590



**Figure 33. Production of phenols by strawberry tissue in basal MS medium. A.** Basal MS medium after the 20 min incubation with agrobacteria without the added wash step. **B.** Basal MS medium after the 20 min incubation with agrobacteria after the addition of the wash step.





**Figure 34. Growth of strawberry tissue after the addition of charcoal to the regeneration and selection medium. A.** Strawberry tissue immediately following the incubation in the dark. **B.** Strawberry tissue after 3 weeks in the lighted chamber on strawberry selection medium. **C.** Close up of the callus shown in B.