

## ABSTRACT

KERKHOFF VESSA, SHEA NICOLE. Designing Global Futures: A Mixed Methods Study to Develop and Validate the Teaching for Global Readiness Scale. (Under the direction of Dr. Hiller Spires).

Our world is increasingly interconnected economically, environmentally, politically, technologically, and socially. In response, leaders have called for more global education in our K-12 schools. Current global readiness frameworks put forward by the US Department of Education, Partnership for 21<sup>st</sup> Century Skills, and others are widely used; however, they are not empirically grounded and tested. This study took steps towards an empirically validated construct of teaching for global readiness.

A sequential exploratory mixed methods design (QUAL → quan) was utilized to operationalize and validate the construct teaching for global readiness. Mixed methods enabled both comprehensibility and generalizability. Data collection and analyses were grounded in educational cosmopolitanism (Hansen, 2008; Wahlström, 2014) and pedagogy of multiliteracies (New London Group, 1996; Cope & Kalantzis, 2009). After defining teaching for global readiness through exploratory qualitative analysis of 24 expert teacher interviews, an instrument was developed and administered to K-12 classroom teachers across the US. Based on EFA and CFA results using split-half samples from 630 respondents, teaching for global readiness was interpreted as a multidimensional construct with four factors: *situated practice*, *integrated global learning*, *critical literacy*, and *transactional experiences*. The end product was a measurement model and scale of teacher practices related to global readiness instruction. By defining and validating the construct, this study provides empirical foundation for future work in advancing evidenced-based theories,

policies and practices for global readiness education. This study addresses the need for the teaching for global readiness scale, shares related research, describes the development of the instrument, evaluates the validity and reliability of the instrument, and considers the prospective contributions of the teaching for global readiness scale.

© Copyright 2016 by Shea Nicole Kerkhoff Vessa

All Rights Reserved

Designing Global Futures: A Mixed Methods Study to Develop and Validate the  
Teaching for Global Readiness Scale

By  
Shea Nicole Kerkhoff Vessa

A dissertation submitted to the Graduate Faculty of  
North Carolina State University  
in partial fulfillment of the  
requirements for the degree of  
Doctor of Philosophy

Curriculum and Instruction

Raleigh, North Carolina

2016

APPROVED BY:

---

Dr. Hiller Spires  
Committee Chair

---

Dr. Jessica DeCuir-Gunby

---

Dr. Shaun Kellogg

---

Dr. Duarte Morais

---

Dr. Ruie Pritchard

## BIOGRAPHY

Shea Kerkhoff earned her B.S. in English Education from Ball State University and M.Ed. in International Education Policy and Management from Vanderbilt University. She taught high school English for seven years, including Wake County Public Schools in North Carolina (NC) and District of Columbia Public Schools. Currently, she serves as *4 the World's* Education Director and teaching assistant at North Carolina State University, where she pursued her Ph.D. in Curriculum and Instruction with a focus in Literacy. In these roles she has led two alternative spring break trips of NCSU students and faculty to Belize and Guatemala for service learning. Shea serves as the adviser to the student chapter of *4 the World* at NCSU. In 2014 as a research assistant with North Carolina Department of Public Instruction, Shea helped create the Global Ready School Rubric. Shea worked with the Global Education team to design the method, analyze the findings, and present the final document. As a graduate assistant at NCSU, Shea taught *Reading Print and Digital Texts Across the Disciplines* and was part of the *Disciplinary Literacy for Deeper Learning* MOOC-Ed design team. In this role, she reviewed the literature on disciplinary literacy, designed the English language arts model project, and provided feedback to participants on the forums. Most recently, Shea served as coach to a cross-cultural collaboration team of American and Chinese teachers at the 2015 New Literacies Teacher Leader Institute. Passionate about her research – including adolescent literacy instruction, disciplinary literacy, global education, and gender equality – Shea is a lifelong learner who strives to instill a love of learning into her students.

## ACKNOWLEDGEMENTS

First and foremost, I would like to thank my advisor Dr. Hiller A. Spires. You have taught me so much, from how to conduct research to how to eat squirrel fish. You have a unique gift for challenging people to do more than they thought possible and supporting them to accomplish their dreams. Thank you for always taking time to teach me.

I would also like to thank my committee. Dr. Duarte Morais, your work has made my work possible, as well as the work of numerous others. Dr. Jessica Decuir-Gunby, you are a triple threat – teacher, researcher, and leader. Dr. Ruie Pritchard, thank you for taking the time to close read my papers and give me such meaningful feedback. Dr. Shaun Kellogg, thank you for giving me time during your busy days to show me what I needed to know.

Thank you to my family and friends who have supported me through this process. To my favorite teacher, my husband, you are my rock. To my mother-in-law, you have always encouraged me to make a difference in this world. Your support means the world to me. To my mom and dad, thank you for your unconditional love and unconditional support. Everything I am I owe to you. To my son Gavin, thank you for letting me read *A First Course in Factor Analysis* as your bedtime story for so many months. You all are appreciated more than I can say.

Above all, I thank God. To God be the glory.

## TABLE OF CONTENTS

LIST OF TABLES .....	vi
LIST OF FIGURES .....	vii
CHAPTER 1 – INTRODUCTION .....	1
Context of the Problem .....	2
Purpose Statement and Research Questions .....	3
Methods Overview .....	4
Theoretical Framework .....	5
Subjectivity statement .....	5
Worldview paradigm .....	6
Content theories .....	7
Summary of Chapter .....	12
CHAPTER 2 – REVIEW OF LITERATURE .....	13
Literature Review Process .....	14
Necessity of Global Readiness Education .....	15
Global citizenship .....	18
Multiliteracies .....	21
Teaching for Global Readiness .....	22
Educational cosmopolitanism .....	25
Pedagogy of multiliteracies .....	30
Barriers .....	36
How to get there .....	37
Summary of Chapter .....	38
CHAPTER 3 – METHODS .....	41
Research Design .....	42
Qualitative Phase .....	44
Participants .....	45
Data collection .....	49
Data analysis .....	49
Validity and reliability .....	52
Quantitative Phase .....	53
Instrument development .....	54
Sample .....	63
Data analysis .....	65
Validity and reliability .....	67
Ethical Considerations .....	73
Summary of Chapter .....	73
CHAPTER 4 – QUALITATIVE FINDINGS .....	74
Situated Practice .....	74
Integrated Global Learning .....	77
Critical Frame .....	81

Transactional Experiences .....	84
Summary of Findings.....	88
CHAPTER 5 – QUANTITATIVE RESULTS .....	90
Preliminary Data Analysis .....	90
Exploratory Factor Analysis .....	92
Confirmatory Factor Analysis Results.....	98
Internal Consistency .....	104
Summary of Results.....	104
CHAPTER 6 – DISCUSSION AND CONCLUSIONS .....	108
Synthesis of Qualitative and Quantitative Findings .....	108
Implications for Research, Policy, and Practice .....	115
Conclusion .....	120
REFERENCES .....	121
APPENDICES .....	147
Appendix A: Sequential Exploratory Mixed Methods Design Diagram .....	148
Appendix B: Recruitment Emails .....	149
Appendix C: Interview Protocol .....	152
Appendix D: Global Citizenship Scale Example Items .....	153
Appendix E: Content Validity Trial Results .....	154
Appendix F: Informed Consent Form for Research .....	168
Appendix G: Operational Definitions for Content Validity Trial.....	173
Appendix H: Early and Late Respondents Comparison .....	174
Appendix I: Stata Output of Results .....	175
Appendix J: Polychoric Correlation Results.....	185
Appendix K: Teaching for Global Readiness Scale .....	196



## LIST OF TABLES

Table 2.1 Frameworks of Global Citizenship.....	19
Table 2.2 Frameworks of Global Education.....	24
Table 3.1 Table of Participants for the Exploratory Qualitative Interviews.....	46
Table 3.2 Themes, Categorical Codes, and Nodes from Qualitative Analysis.....	50
Table 3.3 Potential Items for the Teaching for Global Readiness Scale .....	56
Table 3.4 Additional Potential Items Added to the Teaching for Global Readiness Scale.....	63
Table 3.5 Table of Quantitative Participants .....	70
Table 5.1 Factor Loadings from Exploratory Analysis .....	96
Table 5.2 Item-to-Factor Statistics from Confirmatory Factor Analysis.....	100
Table 5.3 Goodness of Fit Statistics for Measurement Model.....	102
Table 5.4 Reliability Statistics for Teaching for Global Readiness Scale .....	104
Table 5.5 Teaching for Global Readiness Scale Statistics.....	105

## LIST OF FIGURES

<i>Figure 1.1</i> Definition of Global Readiness.....	8
<i>Figure 1.2</i> Teaching for Global Readiness Theoretical Framework .....	9
<i>Figure 3.1</i> Teaching for Global Readiness Mixed Methods Scale Development Design Diagram.....	42
<i>Figure 3.2</i> Themes and Categorical Codes for the Construct Teaching for Global Readiness .....	52
<i>Figure 3.3</i> Four Cognitive Processes Used in Responding to Survey Items .....	60
<i>Figure 3.4</i> Instrument Development Design Process .....	67
<i>Figure 5.1</i> Scree Plot of Eigenvalues .....	92
<i>Figure 5.2</i> Standardized Factor Loadings for the Four-Factor Confirmatory Factor Analysis.....	103
<i>Figure 6.1</i> Teaching for Global Readiness Model.....	113

## CHAPTER 1 – INTRODUCTION

Globalization has become a major issue in the field of education (e.g., Apple, 2011; Delores et al., 1996; Suarez-Orozco, 2001). Our world is increasingly interconnected economically, environmentally, politically, technologically, and socially (Mansilla & Jackson, 2011; Merryfield, 2008; Pike, 2015). In response to globalization, education leaders have called for more global education in our K-12 schools (Gardner, 2009; Reimers, 2009; Stewart, 2007). In 2012, the United States Department of Education (USDOE) issued a report entitled *Succeeding Globally through International Education and Engagement* that included the following goal: “Increase the global competencies of all U.S. students, including those from traditionally disadvantaged groups” (p. 5). This means that in addition to being college, career, and civics ready, all students should be “global ready.” The report defined *global competencies* as “21<sup>st</sup> century skills applied to the world” (USDOE, 2012, p. 5). Twenty-first century skills include collaboration, communication, and problem solving (Partnership for 21<sup>st</sup> Century Skills [P21], 2014), so *applied to the world* means cross-cultural collaboration, cross-cultural communication, and solving global problems. Reaching this goal requires instruction focused on global readiness for all K-12 students.

The public seems to agree. According to a report by the Association of International Educators (NAFSA, 2003), over 90% of Americans believe that global education is a key to preparing children for success in the 21<sup>st</sup> century. However, some business leaders believe our schools are not producing enough global ready graduates (Committee for Economic Development, 2006; Stewart, 2012). Since the turn of the century, concern for the global

readiness of US graduates has increased (e.g., National Governors Association & Council of Chief State School Officers, 2010).

### **Context of the Problem**

Comprehensive global education may help students access the global job market and solve global social issues. To address the need for global education, internationalizing preservice teacher education has become a growing focal point in teaching and research (e.g., Jennings, 2006; Merryfield, 2000; Quazada, 2005; Zhao, 2010). Much of the literature focuses on increasing global competence of preservice teachers. However, research about teaching practices that lead to global readiness at the K-12 level has been slow to evolve (Cushner, 2012; Parkhouse et al., 2015). After a review of the literature on internationalizing preservice teacher education and global education at the K-12 level, my theoretically grounded definition of *global ready* is *global citizens with the multiliteracies necessary in the 21<sup>st</sup> century to participate, collaborate, and work in a global society*.

In October of 2014, the Partnership for 21<sup>st</sup> Century Skills (P21) announced the Framework for Global Education. The framework, written by VIF International (formerly, Visiting International Faculty), sets standards for global ready teaching and learning in every subject for every grade K-12. While this framework is conceptually sound, it is not empirically tested. The purpose of this study was to fill the gap in the research by offering an empirically-tested framework for teaching for global readiness. The following discussion provides an overview of the purpose statement and research questions, methods, and theoretical framework of this study.

## **Purpose Statement and Research Questions**

The purpose of the study was two-fold. The primary purpose was to validate the construct of teaching for global readiness. The secondary purpose was to develop a scale that collects an array of data on teaching practices that promotes students' global readiness. The purpose of this exploratory sequential design was first to examine a small sample qualitatively and then to determine whether the qualitative findings generalize to a large sample. The first phase of the study was a qualitative exploration of what it means for inservice teachers to prepare their students to participate, collaborate, and work internationally. Interview data were collected from a maximum variation sample of expert teachers and teacher educators from the Global South (e.g., Belize) and East (e.g., China) as well as North and West (e.g., U.S.). The Global South and East represent the developing world that receives aid from the U.S. as well as the emerging economies that are perceived as economic competitors with the U.S.

Because validated instruments to assess teaching for global readiness did not exist, an instrument was developed based on the qualitative views that emerged from the data. From this initial exploration, the qualitative findings were used to develop measures that can be administered to a large sample. Themes from interview data were developed into an instrument so that a series of hypotheses about teachers' practices related to teaching for global readiness can be tested. In the second phase, quantitative data on teaching for global readiness were collected from 630 public school K-12 teachers in the U.S. The purpose of the study determines the research questions, which include:

- How can we operationalize teaching for global readiness?

- What do global education experts believe are the components of teaching for global readiness at the K-12 level?
- What are the factors of the teaching for global readiness construct?

### **Methods Overview**

The research questions act as the hub of the research design and determine what methods should be used to acquire the knowledge needed (Clark & Badiee, 2010; DeCuir-Gunby, 2008; Onwuegbuzie & Mallette, 2011). Because no empirical model or scale existed at the time of the study to measure teaching for global readiness, this study aimed to define and measure teaching for global readiness using a sequential exploratory mixed methods design (Creswell & Clark, 2011; DeCuir-Gunby, 2008). A QUAL → quan approach was taken. The qualitative portion was emphasized because the quantitative process stems from the qualitative process. The sequential exploratory approach is considered best practice for theory and scale development in the social sciences (Benson & Clark, 1982; Clark & Watson, 1995; DeCuir-Gunby, 2008; Vogt, King, & King, 2004). This study is classified as sequential mixed methods because one method builds upon the other method (Creswell & Clark, 2011). A mixed methods study draws on the strengths of both qualitative (i.e., participant perspectives) and quantitative (i.e., the ability to generalize) methods in order to include both in meta-inferences (DeCuir-Gunby, 2008; Johnson & Turner, 2003). Qualitative and quantitative measures were taken to ensure reliability and validity, including statistics for construct validity.

## **Theoretical Framework**

A researcher's beliefs, assumptions, and knowledge – whether intentional or not – shape her investigations (Crotty, 1998; Lincoln & Guba, 2000). As Guba and Lincoln (1994) point out, “What can be known is inextricably intertwined with the interaction between a particular investigator and a particular object or group” (p. 110). Because of this, it was important to examine and acknowledge the theories I subscribed to that shaped this study. My theoretical framework for global education comprised three parts: subjectivity statement, worldview paradigm, and substantive content theories (see DeCuir-Gunby & Schutz, in press).

**Subjectivity statement.** My strong belief in the importance of global education stemmed from my experiences in international development work and K-12 public classroom teaching. In these roles, I saw the effects of globalization both at home and abroad as well as the effects of education reform on education quality.

When I went to high school, the only high-stakes test was the SAT. We took the Indiana standardized examination (I-Step) every few years, but it did not affect our grades, our graduation, our school's funding or our teachers' job status. When I began teaching in 2001, the use of state tests began to change. The attention paid to high-stakes tests increased rapidly and teachers were often blamed when students failed to perform well on these tests. I believed that the purpose of my class was to teach students to think for themselves, to become globally and culturally aware, and to develop a sense of social responsibility. At the same time, I felt an overwhelming pressure to teach test preparation, rather than those life competencies, since those skills were not tested. Because of this, I left the classroom and

pursued a master's degree in international education policy where I learned about accountability policies in education, market-based educational reforms, and education for social cohesion.

After receiving my master's degree, I traveled internationally, working in Ghana, Kenya, Myanmar, India, Belize, and Guatemala. With my graduate supervisor, I have also worked in China and with Chinese teachers in the U.S. My professional international travel and personal travel throughout Europe and the Americas have taught me about other cultures, about myself, and about the world. Through international travel, I have grown more personally and professionally than from any other experiences, and I believe more strongly than ever that global awareness is a vital component to a person's education.

**Worldview paradigm.** My research is shaped by pragmatism and epistemological pluralism. I believe that the research questions should determine the methods and that research should investigate problems in a way that contributes to practice (Datta, 1997; DeCuir-Gunby & Schutz, in press; Gutiérrez & Penuel, 2014). Pragmatism offers a democratic platform for multiple perspectives to be heard (Dillon, O'Brien, & Heilman, 2000). I believe that multiple perspectives are valuable and valid. As such, I believe in epistemological pluralism, which views rationality as contextual and holds that multiple rationalities can co-exist (Gilligan, 1982). Specifically, epistemological pluralism for global education in the 21<sup>st</sup> century (Andreotti, 2009; Kim & Slapac, 2015) informed how data were collected, analyzed, and interpreted in my study by emphasizing that knowledge and learning are socially constructed, fluid, and contextual. The most important thing a teacher can teach students is not a body of knowledge but how to question and how to learn. Because I believe



that knowledge is contextual, I developed a model of teaching for global readiness for the U.S. context. Because I value multiple perspectives, I interviewed expert teachers from around the world and from different experiences to hear their perspectives on global education in the U.S. Next, I will discuss the specific content theories that inform this project.

**Content theories.** Part of education in a democratic society is to promote a literate citizenry. The U.S. has long promoted traditional literacy and national citizenship education. But the U.S. is changing. Our students will potentially face new technologies, new cultures, and new challenges that will change continuously. Manfra and Spires (2013) stated, “The world’s knowledge-and-innovation environment favors those who have global awareness and competence, strong communication capacity, the ability to collaborate to solve unfamiliar problems, and the ability and flexibility to adapt well to new challenges” (p. 390). In a democratic global information society, global readiness includes national citizenry and traditional literacy in addition to global citizenship and multiliteracies. Figure 1.1 summarizes my theoretically-grounded definition for global readiness. These theories are compatible but are from two different disciplines, social studies education and literacy education respectively.



*Figure 1.1.* Definition of global readiness.

According to Banks (2008) and the New London Group (1996), tensions in the field of education exist between local and global, private and public, and tradition and innovation, among others. These tensions suggest that students must develop a way to negotiate being open to the new, while remaining critically reflective of the present. Students can develop a multiplicity of literacies: critical literacy (McLaughlin & DeVogd, 2004; Street, 2003); multimodal literacy (Jewitt & Kress, 2003); multilingual literacy (Cope & Kalantzis, 2009); and new social practices, skills, and dispositions needed for new literacies (Leu, Kinzer, Coiro, Castek, & Henry, 2013; New London Group, 1996). They can develop global competence, a sense of social responsibility, and engagement in global civic issues (Morais & Ogden, 2011). When students socially engage as global citizens, they are embracing a cosmopolitan identity (Hansen, 2010a; Wahlström, 2014).

My theoretical framework for teaching for global readiness is built upon Figure 1.1 and is composed of educational cosmopolitanism (Hansen, 2010a; Spector, 2014) as the

theory of global citizenship education, and pedagogy of multiliteracies (New London Group, 1996) as the theory of 21<sup>st</sup> century instruction. Figure 1.2 summarizes the theoretical framework of this study. Pedagogy of multiliteracies embraces what Gee (1999) called the “social turn” and Mills (2010) called the “digital turn” in education. In addition to embracing the social and the digital, Beck and Sznaider (2006) call for a “cosmopolitan turn” in education. Pedagogy of multiliteracies and educational cosmopolitanism theories are compatible because together they address the three modern “turns” in education and because they address different components of the study. Cosmopolitanism is a way of looking at the world or a belief system. Educational cosmopolitanism is a normative theory, meaning that it explains how teachers should make decisions, and a methodological theory, meaning that it helps educational researchers make design decisions (Wahlström, 2014). Pedagogy of multiliteracies is a theory of instruction, meaning that it is based on observation and describes how to help students grow (Bruner, 1966).



*Figure 1.2.* Teaching for global readiness theoretical framework.

***Educational cosmopolitanism.*** The definition of *cosmopolitanism* is contested as it is used differently in various fields. This was not problematic for the study because according to Hansen (2010b), a single view of cosmopolitanism would be “limiting” (p. 152). As it stands, disciplines emphasize different aspects (i.e., political, ethical, moral, critical) and multiple views reflect the very nature of the term. For the purpose of this study, Hansen’s (2008) *educational cosmopolitanism* provided the theoretical foundation. Wahlström (2014) conceptualized educational cosmopolitanism as having four dimensions: reflexivity, hospitality, intercultural dialogue, and transactions of perspectives. Reflexivity emphasizes the critical component of cosmopolitanism and hospitality emphasizes the ethical (Spector, 2014). Teachers grounded in educational cosmopolitanism teach critical global citizenship, which uses inquiry and critical literacy in order to change systems of inequality (Andreotti, 2007; Delanty, 2012; Wright & Andreotti, 2014) and embraces ethics whereby people care for human lives whether those lives are local, national, or global in relation (Appiah, 2006; Nussbaum, 1996, Wahlström, 2014).

*Cosmopolitan* is an ancient Greek word that literally translates to *citizen of the world* (Appiah, 2006; Hansen, 2010a). This citizenship does not displace local or national allegiances; it adds global allegiance (Rizvi, 2008; Wahlström, 2014). Cosmopolitan theory describes people in the world as interconnected. People have traded or moved across political borders for millennia. What is new is that information and communication along with transportation technologies make our connections faster and more frequent (Banks, 2008; Hull & Stornaiuolo, 2014; Leu et al., 2013). The opportunity for and the likelihood of intercultural dialogue and transactions of perspectives are heightened. In this theory, people

across the world are united in a global community with shared universal values while at the same time recognizing and respecting differences (Appiah, 2006; Hansen, 2010a; Wright & Andreotti, 2014; Rizvi, 2008). The theory also acknowledges the diversity within a culture and encourages dialogue as part of learning (Appiah, 2006; Hansen, 2010a).

*Pedagogy of multiliteracies.* The second theory that informed my study was pedagogy of multiliteracies (New London Group, 1996). Pedagogy requires meaning making situated in the connections between “doing something and being someone” (Gabel, 2002, p. 180). Thus, the concept of multiliteracies shares cosmopolitanism’s way of being and adds a way of doing in the classroom. This pedagogy aligns with the changing ideas of identity, culture, and citizenship in the 21<sup>st</sup> century (Kim & Slapac, 2015). Pedagogy of multiliteracies was conceptualized by a group of prominent literacy scholars who met in New London to discuss the current state and the future of literacy pedagogy. Their collective analysis was that the world had become more locally diverse and globally connected, that the workplace now valued multiskilled workers, and that information and communication technologies were producing a variety of multimodal texts. They agreed that a monolingual, monocultural literacy pedagogy should not be taught anymore and coined the term “multiliteracies” to account for the plurality of text types and discourses that could be taught to students with differences in culture, language, gender, (New London Group, 1996, p. 63) and ability (Cope & Kalantzis, 2009). In this theory of pedagogy, practitioners, (a) situate the learning in a relevant way, (b) utilize overt instruction to demystify discourses, (c) teach critical thinking, and (d) facilitate knowledge construction so that students are transformed

through the learning (New London Group, 1996). These two theories will be described in more depth in chapter two.

### **Summary**

Today's students are being called to graduate global ready. A *global ready graduate* is defined as a global citizen with the multiliteracies necessary in the 21<sup>st</sup> century to participate, collaborate, and work in a global society. The problem is that teachers may not be trained in preparing students for global readiness (Parkhouse et al., 2015). Good teaching should be grounded in theory and research. This chapter introduced a theoretical framework based on educational cosmopolitanism (Hansen, 2008) and pedagogy of multiliteracies (New London Group, 1996) to ground teaching for global readiness; this framework was then tested empirically through a construct validation process. Pedagogy of multiliteracies formed the basis of the teaching portion while also informing the global portion of my theoretical framework. Educational cosmopolitanism underpinned the global portion while also informing the teaching portion. In this way, educational cosmopolitanism and pedagogy of multiliteracies were complementary and equally inform my study.

## CHAPTER 2 – REVIEW OF LITERATURE

Today's world is increasingly interrelated and interconnected (Friedman, 2006; Mansilla & Jackson, 2011; Merryfield, 2008; Stewart, 2007). In addition to global interconnectedness, increased migration has led to more diversity in our schools (Apple, 2006; Banks, 2008; New London Group, 1996; Suarez-Orozco, 2001; Zhou, 2010). The effects of a quickly changing society on teaching and learning are central issues in the field of education today (Spring, 2008). Many researchers have suggested that students must develop new literacies, new competencies, and new ways of thinking to be ready for college, career, and civic life in this global knowledge society (Andreotti, 2010; Gee, 2008; Lankshear & Knobel, 2003; Street, 2003).

Teachers are in a position to prepare the 21<sup>st</sup> century student to be ready to participate and work in a locally diverse and globally interconnected society (New London Group, 1996; Zhao, 2010). Global education aims to prepare students for college, career, and civic life in a global society (Dagenais, 2003); however, some have criticized US schools for omitting of global education from the curriculum (Barker, 2000; Friedman, 2006; Haywood & Siaya, 2001). What our students may need in order to communicate and interact in today's globally-interconnected information society are both multiliteracies and global citizenship. Together, these concepts form the construct *global readiness*. Presently, NAFSA Association for International Education, North Carolina (NC) State Board of Education, VIF International, and Partnership for 21<sup>st</sup> Century Skills (P21) also use the term *global ready*. I adopted this term because it is all encompassing of the multiple and new literacies as well as the global competence and citizenship needed in the 21<sup>st</sup> century. Teaching for global

readiness is not just for world language teachers or for social studies teachers; all K-12 teachers hold the potential to promote global readiness (Durtka et al., 2002; Smith, 2002).

### **Literature Review Process**

Although many authors in the field of education have spotlighted and empirically analyzed teaching 21<sup>st</sup> century skills (e.g., Cope & Kalantzis, 2000; Lankshear & Knobel, 2003; Leu, 2001), fewer studies have empirically analyzed how to teach for global readiness (Parkhouse et al., 2015; Van Hoof & Verbeeten, 2005), especially at the K-12 level (c.f. Learn NC, 2014; Mansilla & Gardner, 2007). Questions regarding the connection between traditional education and global education in contemporary society remain. In particular, how are 21<sup>st</sup> century literacies interrelated with global citizenship in the professional literature? For shifts in learning to occur, shifts in teaching must precede. The second question examined within this discussion is, what pedagogy will promote global readiness (i.e., global citizenship in addition to multiliteracies) in our students? These unresolved questions guided my literature review.

My goals were twofold: (a) examine empirically validated constructs of global citizenship; and (b) synthesize the research on teaching K-12 global education in the 21<sup>st</sup> century. In searching for relevant literature, I utilized several education databases (e.g., ERIC, Academic Search Complete, Google Scholar) and the footnote method, using references in the articles I read to find more research (Shanahan, 2001). I used the search phrases *global citizenship*, *global competenc\**, *global read\**, *global-read\**, *global education*, *cosmopolitanism*, *new literac\**, *multiliteracies*, *21<sup>st</sup> century literac\**, *teaching*, *instruction*, and *pedagogy* with the search criteria of full text available and peer reviewed.



I reviewed the literature inside and outside of the U.S. context because there were not many empirical studies. Educating for global readiness is considered a goal for teachers worldwide (Darling-Hammond, 2010; Gundara, 2000; Reimers, 2010; Tye, 2014). However, one's definition of global readiness is shaped by one's historical, social, and cultural context (Deardorff, 2006). For example, Baumgratz (1995) claimed that the European view is different than the U.S. view in that the paradox of global citizenry and global competition is more apparent in Europe. Therefore, I needed to contextualize the review to the U.S. because global readiness is tied to culturally-situated values and beliefs, so when reviewing literature from Europe, Canada, and Australia, I read critically for possible contextual differences. To analyze and synthesize, I conducted a thematic content analysis (Braun & Clarke, 2006). Keeping the questions in the forefront, I read the studies, highlighted key quotes and wrote notes in the margins. Then, I generated initial codes across the data and gathered like data by comparing and contrasting codes to identify themes. Next, I reviewed the themes for internal homogeneity and external heterogeneity, reviewing the articles to make sure the themes were comprehensive yet supported (Braun & Clarke, 2006).

### **Necessity of Global Readiness Education**

Much of the conceptual literature on global education is a synthesis of research from higher education or business fields on why global education is imperative in the 21<sup>st</sup> century. Researchers assert that global education is needed because globalization has flattened the world economy, the demands on the workforce are changing, global migration is higher than in the past, and the climate is changing (Hansen, 2010a; Mansilla & Jackson, 2011). Comprehensive global education may help students access the global job market and solve

global social issues. In this section I will first synthesize the research on the changing job market and then the globalization of social issues.

In the past, education in America focused on reading, writing, and arithmetic-- specifically reading print texts, writing that is formal and academic, and calculating arithmetic --in order to prepare students for work in an industrialized society. However, research indicates that work life has changed (Gardner, 2009; Levy & Murnane, 2004, 2007). Work life in the 21<sup>st</sup> century for the middle class job market includes gathering and analyzing information, communicating using technology, and solving problems (Gardner, 2009; Leu, Kinzer, Coiro, Castek, & Henry, 2013; Levy & Murnane, 2004, 2007; New London Group, 1996). Research indicates that work includes being able to think creatively and critically as well as communicate and collaborate interculturally (Deardorff, 2006; New London Group, 1996). According to Committee for Economic Development (2006) reports, the US workforce has a shortage of globally competent individuals. Hayward and Siaya (2001) surveyed over 1000 US adults and 500 high school seniors about global education. According to their study, 93% agreed that the workforce needs to be able to collaborate with people from different cultures, 90% agreed that global education would help them work with people of other cultures, and 88% said it would give them a competitive edge in the work force. The general public, as well as students, saw that intercultural collaboration would be part of their future work lives and believed that global education is important.

Global education may increase students' social networks. Students' network of global connections established in school may be useful for conducting international business in the future (Bremer, 2006). Through these increased networks, collaborations hold the

potential to teach students about culture. Students may gain international perspectives, deeper appreciation of other countries and cultures, and knowledge of diverse societies' contributions (Black & Duhon, 2006; Bremer, 2006; Hadis, 2005; Suarez-Orozco, 2007; Van Hoof & Verbeeten, 2005). Empirical studies have found ethnocentrism is reduced (Union & Green, 2013), stereotypes are reduced, and respect for other cultures is increased (Besnoy, Maddin, Eisenhardt, & Steele, 2015). Not only do students have the potential to learn about other cultures, they can learn about American culture as well (Myers & Eberfors, 2010; Smiles, 2001). When students observe other cultures, they may see other ways of knowing and doing. Comparison and contrast can help students identify their own cultural beliefs, values, and customs. Global education holds promise to promote important interpersonal skills, such as cross-cultural communication and collaboration (Akande & Slawson, 2000; Lindsay & Davis, 2013; Sussmuth, 2007) as well as intrapersonal skills, such as identity clarification (Banks, 2008; Hull, Stornaiuolo & Sahni, 2010).

The challenges we face locally or nationally often go beyond our borders and impact diverse groups of people. Likewise, issues in other countries often affect us (Mansilla & Jackson, 2011; Moffatt, n.d.; New London Group, 1996; Noddings, 2005). According to the National Academy of Engineering (2015), today's global challenges include ending extreme poverty, providing sustainable green energy, increasing fair global trade, reducing epidemics, and promoting peace and social cohesion. Research suggests that these global challenges require citizens to "make informed judgments by accessing accurate information, discerning the nuances of multiple points of view, and communicating their own perspectives to affect change" (Orozco-Domoe, 2015, p. 61). Moreover, the way that the global citizenry of the

21<sup>st</sup> century advocates for desired civic actions may require the use of communication technology and other tools that did not exist even a few years ago or that have yet to be imagined (Leu et al., 2013; New London Group, 1996; Partnership for 21<sup>st</sup> Century Skills, 2014). To solve the global issues of today, students may need to develop the same skills described above for today's workforce (Gardner, 2009). Future graduates may need to be both globally competent and multiliterate in order to be successful as they use technology to work and interact with culturally and geographically diverse people (New London Group, 1996; West, 2010). Global citizenship and multiliteracies combine to form the construct global readiness.

**Global citizenship.** As *cosmopolitanism* is translated as *citizen of the world*, the word *citizen* must be defined in order to understand what cosmopolitanism really means. A foundational document in the field is by Hanvey (1982). Hanvey's definition and structure "has probably influenced the global education movement more than any other one document" (Merryfield, 1997, p. 3). A second highly influential conceptual framework is that by Mansilla and Jackson (2011) from the Asia Society, a highly regarded nonprofit for global education.

Two empirical studies have developed and validated a construct related to global readiness. Deardorff (2006) utilized a qualitative Delta method to define and validate the construct of international competence. Morais and Ogden (2011) utilized quantitative methods to develop and test the factors of global citizenship. Both of these studies were intended to measure the construct with undergraduate students. While Deardorff's model is frequently cited in higher education, Morais and Ogden's scale is beginning to be utilized in

K-12 research because of its apparent relevance to people of all ages. The dimensions of global citizenship, or the related terminology, are listed in 2.1. (For full discussion of related terminology see Sinicrope, Norris, & Watanbe, 2007).

Table 2.1.

*Frameworks of Global Citizenship*

Global Perspective (Hanvey, 1982)	Global Citizenship (Morais & Ogden, 2011)	Global Competence (Mansilla & Jackson, 2011)	Intercultural Competence (Deardorff, 2006)
State of the planet awareness	Global competence including a) global knowledge, b) intercultural communication, and c) self-awareness	Investigate the world	<b>Requisite Attitudes:</b> Respect, openness, curiosity, and discovery
Knowledge of global dynamics	Social responsibility	Recognize other's and own perspectives	<b>Knowledge &amp; Comprehension:</b> Cultural self-awareness, deep understanding and knowledge of culture, culture-specific information, and sociolinguistic awareness
Perspective consciousness	Global civic engagement including	Communicate ideas effectively to diverse audiences	<b>Skills:</b> To listen, observe, interpret, analyze, evaluate, and relate

Table 2.1. (Continued)

Global Perspective (Hanvey, 1982)	Global Citizenship (Morais & Ogden, 2011)	Global Competence (Mansilla & Jackson, 2011)	Intercultural Competence (Deardorff, 2006)
Awareness of human choices	a) involvement in civic organizations, b) political voice, and c) global civic activism	Take action	<b>INTERNAL OUTCOMES:</b> Adaptability, flexibility, ethnorelative view, and empathy
Cross-cultural awareness			<b>EXTERNAL OUTCOMES:</b> Behaving and communicating effectively and appropriately (based on one's intercultural knowledge, skills, and attitudes) to achieve one's goals to some degree

Because Morais and Ogden's (2011) framework is empirically validated and the most relevant for K-12 students, I chose to utilize their definition of global citizenship for this study. Their scale consists of three factors: (a) global competence, (b) social responsibility, and (c) global civic engagement. Global competence includes being able to communicate cross-culturally and being both globally and self-aware. Social responsible students evaluate the global consequences of their own and others' actions. With global civic engagement

students participate in their community and act on issues of local and global importance (Morais & Ogden, 2011).

**Multiliteracies.** In addition to global citizenship, research suggests that students develop multiple new literacies to be ready for college, career, and civic life in the global 21<sup>st</sup> century (Coiro, Knobel, Lankshear, & Leu, 2008). Reading and writing today involve new text-types (e.g., hyperlinked text, nonlinear navigation); new skills (e.g., key word searching, reading across modes); and new dispositions (e.g., critical stance, contributing information to text). This has led researchers to broaden the definition of literacy to include the new literacies needed for digital texts and multimodal systems of communication that are widely used on the Internet and other communication technologies (ICTs). Different researchers refer to this theory as *new literacies* (e.g., Leu et al., 2013), *New Literacy Studies* (e.g., Street, 2003), and *multiliteracies* (e.g., New London Group, 1996).

The *multi* of *multiliteracies* refers to *multilingual* as well as *multimodal* (Cope & Kalantzis, 2009). Speaking different languages (Ismail & Cazden, 2005) as well as different discourses (Gee, 2008) is recognized as part of functionality in a global society. Reading and writing have always involved multimodal text types (i.e., pictures and words) and the critical stance, but the internet and other ICTs makes multimodality and the critical stance the norm (Siegel, Kontovourki, Schmier, & Enriquez, 2008; Spires & Estes, 2002). Literacy includes gathering and analyzing multimodal information as well as communicating in multiple modalities by using technology (Kress, 2009; New London Group, 1996). The importance of cross-cultural communication increased with the increase in ICTs making communication across the globe quicker and more frequent. Multimodal communication is an important

dimension of cross-cultural communication (Kress, 2012). In addition, the importance of inquiry skills and critical reading skills increased with the increase of ICTs (Leu et al., 2013). Research suggests that online literacy requires students to identify a problem or research question, locate reliable sources both online and offline, read through a critical lens, construct knowledge by synthesizing information from multiple sources, and communicate using the appropriate mode(s) (Leu, 2002; Lonsdale & McCurry, 2004; Manfra & Spires, 2013). Research indicates that while students have adapted to hyperlinks and nonlinear reading, they have not as readily adapted to the critical component essential for internet research and comprehension (Coiro, 2003; Lankshear & Knobel, 2011; Leu et al., 2013; Spires & Estes, 2002). Critical literacy is “to read not only the word but also the world” (Friere, 1969, as cited in McLaughlin & DeVogd, 2004, p. 52). As students engage in critical literacy, they analyze the words and also the political and cultural assumptions the author is making (Luke & Freebody, 1999; Street, 2003). Hull, Stornaiuolo, & Sahni (2010) add that in addition to being politically and culturally alert, readers must be morally and ethically alert to their definition of *critical literacy*. This suggests that students make judgments about texts and society.

### **Teaching for Global Readiness**

Global readiness education holds potential to help students become cross-cultural communicators and active global citizens (Ladson-Billings, 2005). In order to reach this potential, Andreotti (2006) advocates for critical, not “soft,” global citizenship education. By *critical*, she means that teachers be transformative citizens themselves and teach critical thinking in order to counter hegemony and transform the way students think about the world.



Feminists and scholars of color have long advocated critical pedagogy that leads to transformation (Banks, 2008). Critical pedagogy goes beyond preparing students for college, career and civic life, by also preparing them to understand, challenge, and dismantle current hierarchical systems and systems of oppression (O'Connor & Zeichner, 2011).

Some theories of global critical pedagogy stem from multicultural education (Lantz & Davies, 2015). The Globally Competent Teaching Continuum (GCTC) was developed with qualitative methods to synthesize literature and interviews with over 100 expert teachers (Learn NC, 2014; Parkhouse, Glazier, Tichnor-Wagner, & Cain, 2015). The GCTC builds on Bank's (1993, 2004, & 2008) model of multicultural education and Gay's (2002) and Ladson Billings's (1995) theories of culturally responsive teaching. A second example of a global teaching framework that stems from social studies education is Merryfield, Lo, Po, and Kasai (2008). Merryfield's research on globally minded teachers has spanned over three decades. Two theories of teaching global education that stem from environmental studies are posited by Bottery (2006) and Earth Council (2002). These theories advocate awareness and care for the earth in addition to awareness of other cultures and care for other peoples. From the field of literacy came the pedagogy of multiliteracies (New London Group, 1996) to account for the multifaceted nature of instruction in a global knowledge society and from multiple disciplines came cosmopolitanism.

The theories with a body of empirical support are educational cosmopolitanism and pedagogy of multiliteracies. Both theories will be discussed in depth respectively.

Table 2.2.

*Frameworks of Global Education*

Global Education (Bottery, 2006)	Earth Council Framework (2002)	Educational Cosmopolitanism (Wahlström, 2014)	Globally Competent Teaching (Learn NC, 2014)	Global Education (Merryfield et al., 2008)	Pedagogy of Multiliteracies (New London Group, 1996)
Ecological and political awareness.	Respect and care for the community of life.	Hospitality.	<b>Dispositions:</b> Empathy and valuing multiple perspectives. Promoting equity worldwide.	Knowledge of interconnectedness.	Situated practice.
Epistemological provisionality.	Ecological integrity.	Intercultural dialogue.	<b>Knowledge:</b> Understanding of global conditions and current events, ways world is interconnected, intercultural communication.	Examine multiple perspectives with an open mind	Overt instruction.
Support public good and public accountability. Professional self-reflection.	Social and economic justice. Democracy, nonviolence, and peace  Affirmation and acceptance.  Emotional literacy.  Cooperation and collaborative problem-solving.  Managing and resolving conflict.	Reflexivity.  Transactions of perspectives.	Experiential understanding of multiple cultures. <b>Skills:</b> Communicate in multiple languages. Integrate content-aligned explorations of the world. Facilitate intercultural and international conversations. Develop and use appropriate methods of inquiry to assess students' global competence. Develop local, national, or international partnerships.	Facilitate cross-cultural experiential learning. Inquiry into global issues.  Teach about power and social justice.  Confront stereotypes and oversimplification.	Critical framing.  Transformed practice.

**Educational cosmopolitanism.** Cosmopolitanism is an orientation to the world that helps one reconcile apparent paradoxes. One modern paradox described by researchers is the global homogenization of culture with simultaneous fracturing of local cultures by increasing migration and production of subcultures (Kim & Slapac, 2015; New London Group, 1996). Research indicates that classrooms around the world are becoming more diverse as global immigration increases. Today, the U.S. is home to a near-record 12.9% foreign-born residents, according to the latest census (US Census, 2011). These residents may bring with them their home culture while trying to integrate into American life. As teachers move beyond superficial knowledge of their multicultural students' past and present circumstances, they may become conscious of bias based on perceived power differentiation between the U.S. and students' home countries (Escamilla, Aragon & Fránquiz, 2009; Ogaz, 2000). As Apple (2011) states:

Superficial knowledge [of students' cultures] may not be much better than no knowledge at all. It may also paint a picture of parents and youth as passive 'victims' of global forces, rather than as people who are active agents continually struggling both in their original nations and regions and here in the United States to build a better life for themselves, their communities, and their children. (p. 223)

Teachers can also help students to develop cosmopolitan identities that move beyond U.S.-centric thinking, move beyond stereotypes, and move forward their own cultural identities so that students can constructively interact with people from all over the world (Merryfield, 2002).

Cosmopolitanism does not advocate for a cosmopolitan identity to replace national or ethnic identities as if identity was a “zero-sum conception” (Kymlicka, 2004, p. xiv; see also Dolby, 2004). Instead, the theory explains how people today often hold multiple identities (Nussbaum, 1996; Noddings, 2010a) and those identities may constantly shift and change (Wahlström, 2014). This corroborates empirical research on K-12 students’ multiple identities across national borders, such as Palestinian-American (Abu El-Haj, 2007), Vietnamese American (Nguyen, 2008), South Asian-American (Maira, 2004), and Mexican-American (Valenzuela, 2013). Ladson-Billings (2004) states that people “move back and forth across many identities, and the way society responds to these identities either binds people to or alienates them from the civic culture” (p. 112). Following this line of reasoning, people may participate in both their ethnic culture and the national culture while also associating with a global culture (McIntosh, 2005; Noddings, 2005) or cosmopolitan identity (Banks, 2008; Rizvi, 2008). These identities are fluid and may change in composition over time (Wahlström, 2014).

Likewise, cosmopolitanism is not a dualistic framework that sees curriculum as either about the nation or the world. Instead from a cosmopolitan view, the communities around the world are seen as interconnected and interrelated. As Rizvi (2008) explains, “This does not mean ignoring local issues, but to understand them within the broader context of the global shifts that are reshaping the very nature of localities” (p. 21). In this way, teachers do not replace teaching about the local for teaching about the global, but instead show how the local is already global (Asia Society, 2015; Appiah, 2006; North Carolina State Board of Education, 2013). In order to unpack the concept of educational cosmopolitanism,

Wahlström (2014) proposed a framework for educational cosmopolitanism “on the ground” with four parts: reflexivity, hospitality, intercultural dialogue, and transactions of perspectives.

**Reflexivity.** There is tension in the literature between the old and new. Some theorists embrace the new homogenization of culture and some resist the loss of indigenous cultures (Beck, 2006; Wahlström, 2014). Cosmopolitanism works for the continuation of indigenous knowledge and cultural traditions while also questioning in a reflexive cycle old traditions that might inhibit the construction of new knowledge useful to the contemporary life (Hansen, 2010a). Appiah (2006) reconciles this tension by scrutinizing change for signs of coercion by hegemonic social factions. Political or economic coercion is not accepted in cosmopolitanism; however, communities are free to change as part of the normal progression of life. In this way, culture, like identity, is not viewed as static and museumified, but as dynamic and constantly renegotiated.

**Hospitality.** Helping students to develop hospitable outlooks is not easy. Gough (2014) describes the challenge in curriculum and instruction: “The practical challenge is how to *perform* an ethics of inclusion rather than a politics of exclusion” (p. 90, emphasis original). Teachers who promote hospitality work to build a common culture based on the multiple cultures of the students in their classroom (Gough, 2014; Wahlström, 2014). At the same time, teachers must teach students about difference in a way that does not fetishize the exotic or oversimplify difference to stereotypes (Hansen, 2010a; Gough, 2014; Merryfield, 2002). For example, teaching about female genital mutilation could be discussed alongside the religious tradition alive in the U.S. of male infant circumcision. Teachers have the

challenge of balancing diversity and unity through their curriculum and instruction. As Banks (2008) asserts, “Unity without diversity results in hegemony and oppression; diversity without unity leads to Balkanization and the fracturing of the nation-state” (p. 133).

Teachers have the potential to discuss with students the relationships and the tensions in loyalties to the local, the regional, the national, and the global (Delanty, 2006; Delores, 1998; Gough, 2014; Hawkins, 2014).

***Intercultural dialogue.*** The tension described above between resisting and accepting change can be viewed as an ethical question in education because blanket tolerance does not work in a classroom. Cosmopolitanism provides a normative ethical theoretical lens (Wahlström, 2014). In other words, the theory provides criteria for deciding what is right and wrong. While tolerance for differing beliefs is encouraged in cosmopolitanism, universal normative values are also encouraged (Appiah, 2006). We do not have to tolerate all behaviors, but we must look at behaviors through the lens of those practicing that custom before judging. Dialogue, listening, articulating, and respecting are valued in “critical tolerance” (Hanson, 2010a, p. 7). For example, the wearing of a hijab should not be judged as oppression of women unless contextualized and investigated with women who wear a hijab. Sexism and other forms of oppression are not tolerated, but differences are seen as complex and multifaceted. Students must understand that common behavior can stem from different beliefs. The wearing of a hijab in one situation may represent a woman’s faith in God, yet in another situation represent a man’s subordination of a woman. Tolerance should be encouraged for traditions that people wish to continue into the present day, as long as these traditions are not coerced and not oppressive (Appiah, 2006).

*Transactions of perspective.* Likewise, the understanding that cultures change should be tolerated. As students engage in intercultural dialogue, they learn from each others' perspectives. Through transactions with other individuals and with their cultures, people accept new ways of thinking or new ways of doing. Hansen (2011) explains that teachers can give students experiences of “reflective openness to the new fused with reflective loyalty to the known” (p. 86). Cultures progress, but engaged citizens do not adopt change blindly. As students consider different perspectives and practices, they engage in critical analysis and reflexivity of their own culture as well as other cultures. In transactional learning experiences, students interact with others, sharing ideas and perspectives in a way that requires a give and take from both parties. Cosmopolitan educators promote equality. Transactions of perspective and reflexivity are key parts of educational cosmopolitanism that students can utilize to create their futures (Hansen, 2010a; Wahlström, 2014).

Cosmopolitan education does not replace skills and knowledge acquisition for career and college preparation. Instead, it “opens a space” for social justice education alongside “preparation for productive life” (Hansen, 2010a, p. 22). This space opens the possibility for critical social theory in the classroom where students learn through experiences that are unfamiliar and teachers help them experience multiple perspectives (Delanty, 2006, 2012). This space helps students clarify who they are and who they want to become in relation to the world and helps them develop self-reflexivity – investigating oneself as affecting and being affected by society. This space also helps them learn intercultural dialogue and respect for others. Teachers do not merely show students the world as it is, but help students to develop the attitudes, knowledge, and dispositions needed to solve the great challenges we face as a

world, such as perspective-taking, empathy, reflection, collaboration, and problem-solving. In summary, a critical global citizen utilizes self-reflexivity, intercultural dialogue, and critical inquiry to create a more just social future.

**Pedagogy of multiliteracies.** Multiliteracies theory embraces culture as dynamic in the same way that cosmopolitanism does (Street, 2003). I have chosen pedagogy of multiliteracies to ground the theory of instruction because it was birthed from globalization, while culturally responsive teaching (Gay, 2002) and culturally relevant pedagogy (Ladson-Billings, 1994) in the U.S. sprang from the civil rights movement and therefore much of the research using culturally responsive pedagogy in the US is based on multicultural and racial identities at the local or national level. However, both educational cosmopolitanism and pedagogy of multiliteracies share a critical frame with culturally responsive and relevant teaching. Educational cosmopolitanism and pedagogy of multiliteracies are compatible theories when used together in global education research (e.g., Hawkins, 2015; Hull & Stornaiuolo, 2014; Vasudevan, Kerr, Hibbert, Fernandez, & Park, 2014).

The purpose of education according to pedagogy of multiliteracies theory is for students to be able to fully and equitably participate in social, public, and economic life (New London Group, 1996). To do this, pedagogy utilizes diversity as a resource not as a barrier or a deficit to quality education (Kim & Slapac, 2015).

To address the diverse needs of students and build upon their knowledge and resources, New London Group proposed pedagogy of multiliteracies with four dimensions:

- situated practice,
- overt instruction,



- critical framing, and
- transformed practice.

These four dimensions will now be explained.

*Situated practice.* Situated practice means that learning is relevant, authentic, and social. This pedagogy makes learning relevant by considering the community, both in the classroom and the larger society within which the learning is taking place. This involves leveraging the texts and topics students are excited or concerned about to build learning conditions that are relevant to students' lives outside of school. Martens et al. (2015) found that carefully selecting global literature during read aloud time in an elementary school was associated with students "developing richer understandings of themselves as complex cultural beings, a deeper appreciation of others and diverse perspectives in the world, and a perception of themselves as capable problem-solvers who take action" (p. 617). In addition to relevant content, situated practice involves authentic inquiry-based learning experiences and collaborative learning opportunities for students to work together to construct knowledge in ways that build 21<sup>st</sup> century skills (Al-Maamari, 2014; Lindsay & Davis, 2013; Spires, Chang, Bot, & Himes, 2015).

Teachers create communities of practice where students feel secure, can take risks, and trust the other members of the community. Each community of practice includes an expert, the teacher or a peer who has already mastered the objective or practice (Cope & Kalantzis, 2009). This pedagogy recognizes the rich cultural heritages that students bring with them to school, capitalizing on students' diverse expertise as resources to the community (Kim & Slapac, 2015; Mills, 2006). However, the New London Group found

that while situated practice is important for learning motivation, it is not enough to bring students to mastery. Students need awareness of their learning and of the historical, political, and cultural context of their experiences. Following this line of reasoning, this pedagogy includes overt instruction and critical framing in addition to creating a community of learners.

***Overt instruction.*** Overt instruction is not direct instruction of rules for a bounded system, but rather instruction of knowledge as being situated and contextual in practice. Teachers are overt about patterns across systems, and show students how to “act flexibly and adaptably to context” (New London Group, 1996, p. 79). Teachers overtly provide connections to students’ prior knowledge, active scaffolding to help students apply what they know to the new context, and assessment of growth. The most emphasized part of overt instruction is to give students an awareness of their knowledge, their meta-knowledge. For example, teachers communicate with students that the academic language they will encounter in textbooks is different from the everyday language people use (Gee, 2008). These differences point toward students becoming aware of how these characteristics play out in the various contexts by applying a meta-knowledge of language. Overt instruction reminds us that schools are not politically neutral and that hidden curricula must move out of the shadows (Apple, 2011). Meta-knowledge may help students access multiple discourses by demystifying the way language is used in academics and other public arenas (Lea & Street, 2006). The potential outcome of overt instruction is a conscious control over one’s learning and a place for teachers to provide feedback for students to grow more than they could have alone.

Overt instruction of micro—or local literacies—and macro—or broader cultural literacies—can possibly help students as they use technology in collaborative learning situations with peers in other countries (Stornaiuolo & LeBlanc, 2014; Street, 2003). Literacy is seen by prominent theorists as social practices that differ across academic communities or social cultures (Gee, 2008; Street, 2003). Students can learn to become aware of and respectful of difference in their audiences, who may have immediate access to their text productions but may be from a different part of the world. Through a cosmopolitan identity, students are shown the moral stance of text production and consumption (Hull & Stornaiuolo, 2014).

These first two dimensions, situated practice and overt instruction, are based on social learning theory (Vygotsky, 1978). Vygotsky theorized that students can achieve more by learning with a teacher or more capable peer than they can learn independently. The next dimension is based on critical social and critical literacy theories.

*Critical framing.* When employing pedagogy of multiliteracies, students' diverse cultural experiences and perspectives are valued as resources. Educators who advocate a critical frame practice critical analysis of the systems within and outside of the classroom to interrupt assumptions, ensure that cultural barriers are broken down, and that differences are seen as resources. They also teach students to think critically and to inquire using critical literacy (Kalantzis & Cope, 2001; Hull, Stornaiuolo, & Sahni, 2010; Morrell, 2002).

Teaching through a critical lens gives opportunities for students to see familiar things in a strange light, in other words, to look from multiple perspectives outside of their norms. *Critical framing* means that teachers integrate critical literacy (McLaughlin & DeVogd,

2004) by questioning the authority of the author/speaker within the content curriculum while also modeling respectful dialogue—or in the words of cosmopolitanism, *hospitable dialogue* (Hull, Stornaiuolo, & Sahni, 2010). Just as cosmopolitanism does not tolerate injustice, pedagogy of multiliteracies emphasizes that the goal of education is “not to produce docile, compliant workers but rather for students to develop the capacity to speak up, to negotiate, and to be able to engage critically with the conditions for their working lives” (New London Group, 1996, p. 66). Critique of multiliteracies considers the theory text-centric (Leander & Boldt, 2013); however, a broad understanding of critical framing expands it from critical literacy to a form of critical pedagogy. Critical framing provides students the tools to tear down systems of inequality and design new, equitable systems.

***Transformed practice.*** Transformed practice involves both the transformation of resources and the transformation of students. In transformed practice, students become designers. Students learn what designs are available, integrate and juxtapose the pre-existing, and redesign to adapt to new contexts. Students are able to transfer what they learn in one situation and apply it, in a new way, to the situation in front of them (Cope & Kalantzis, 2009). This ability is crucial for the quickly changing society in which we now live (Mills, 2006). Leander and Boldt describe transformation of the students:

This [transformation] involved youth actively recognizing and using the “available resources” of multiple modalities as dynamic representational materials and tools for “designing” and then critically “redesigning” their identities, opportunities, and futures as global citizens of an increasingly connected yet diverse world. (p. 25)

This view is in congruence with cosmopolitanism. Hansen (2010a) describes a cosmopolitan approach to teaching as “drawing them [students] into cultural creativity as they learn to do more than mimic the tried and the known, but rather to engage it dynamically with the unfamiliar” (p. 20). Also in congruence with cosmopolitanism, the New London Group emphasizes the reflective manner, learned through overt instruction and critical framing, in which transformed practices should occur.

In order for this pedagogy to take hold, some researchers suggest that teachers embrace epistemological pluralism (Andreotti, 2009; Kim & Slapac, 2015). Epistemological pluralism recognizes knowledge as being constructed by people within a context and acknowledges multiple rationalities. When what was to be learned in school was stable and rule-bound, positivist epistemology could suffice, but pedagogy of multiliteracies emphasizes that knowledge and learning are socially constructed, fluid, and contextual. Following this assertion, the most important thing a teacher can teach students is not a body of knowledge but how to question and design new possibilities. A shift from positivism to pluralism also moves away from one correct or standard academic discourse to allowing multiple competing and complementary discourses to shape the school experience. Criticism of pedagogy of multiliteracies contests the documents authorization of nontraditional discourses in school, namely affective and embodied discourses (Leander & Boldt, 2013). A shift to epistemological pluralism moves away from essentialist views that see literacy and culture as static, or as a noun, to dynamic and embodied, as a verb (Street, 2003). Teachers may help students to become flexible, and open to designing and redesigning as they and the world

they live in continue to change. Most importantly, students have the potential to design the global future that they desire.

**Barriers.** While many tout the goal of teaching for global readiness to be peace and global stability (Reimers, 2009), some view global education curricula as neoliberal, controversial, or overly political (Schukar, 1993). By its social and cultural nature, global education is subject to different political ideologies (Cross & Molnar, 1994; Lantz & Davies, 2015). Even when teachers have strong beliefs for teaching global education, they still may not practice what they believe (Rapoport, 2010).

The literature has indicated that the interaction between beliefs and practices is complex (Pajares, 1992). A variety of constraints may result in teachers' inability to enact their beliefs about education. Limited time, resources, and budgets are barriers to teachers engaging in meaningful global education in their classrooms (Merryfield, 2008; Pike, 2015; Schukar, 1993). If teachers believe in global education, they must learn not only the content but also the processes of global education, such as how to teach controversial topics and conflict resolution (Schukar, 1993). As Allen (2013) states, "Because of the many uncertainties inherent in classroom teaching, teachers may plan practices that are consistent with their beliefs but find it necessary to deviate from their plans during actual instructional time" (p. 136). They may downgrade their own beliefs to students' needs, real or perceived; to administrators' agendas (Allen, 2013); or to curriculum standards (Rapoport, 2010). Teachers need to have the right disposition and also the time in the instructional day, the global knowledge, and the pedagogical skills to act on their beliefs. Most importantly, teachers need solidarity with like-minded teachers to help them overcome political barriers.

On the other hand, one cannot teach for global readiness without being global ready oneself. This is because, if a teacher facilitates an interaction between two peers and the peers learn cross-cultural communication from each other as a byproduct, then the learning was a byproduct and not an outcome of the teaching. According to pedagogy of multiliteracies, there must be a more capable person to scaffold the learner. Teachers cannot presume that there will be capable peers in every class that can scaffold the learning of other peers. However, the teacher should expect each class to learn cross-cultural communication skills. Therefore, the teacher must have metaknowledge about culture and communication in order to scaffold cross-cultural communication and the cosmopolitanism dimension of intercultural dialogue.

**How to get there.** According to empirical studies, professional development abroad coupled with cultural immersion and critical reflection, whether short term tourism or extended teaching assignments, positively impacted teachers' classroom practices of teaching for global readiness. My synthesis of the research suggests that after professional development abroad, teachers perceived greater connections with students and parents, a shift from deficit mindset, increased flexibility and reflexivity, and deeper learning through first-hand experience.

Participants in professional development abroad consistently perceived deeper learning and better understanding than could have been achieved at home (Alfaro & Quezada, 2010; Allen, 2013; Quezada & Alfaro, 2007). A common statement by participants was that experiencing minority status or lack of resources, even for a short time, were lessons better learnt through experience than reading. One of Cook's (2009) participants, who had

traveled to India previously and Japan for the study, articulated, “Experience is the truest and deepest teacher....While I certainly have been met with challenge and hardship, I have grown monumentally each time I have taken the risk to explore myself within another country” (p. 115). While Kruger et al. (2009) was not a research article, data were shared that corroborated this theme. While in South Africa an in-service teacher wrote, “I had to travel half way around the world to begin to understand the issues of racism in the United States” (p. 160). This visceral experience allowed the participant to gain a more in-depth understanding of what life is like for people in other countries and how politics plays a part.

Teachers reported translating their cultural experiences and critical insights into more authentic experiences for their students back inside the classroom. After teaching abroad, educators reported introducing authentic cultural experiences for their students (Quezada & Alfaro, 2007; Cook, 2009), including students’ cultures in the curriculum (Zhao, Meyers, & Meyers, 2009), and “decentering” the U.S. from the curriculum (Patterson, 2013, p. 107). Participants recreated experiences for students so that students could learn different ways of living. One participant expressed her motivation for sharing these experiences with her students: “It is integral that I introduce students to other cultures and other methods of thinking. Our kids need to be flexible, creative, and compassionate” (Cook, 2009, p. 118). One participant reported utilizing the critical reflection pedagogical strategy from his professional development with his own students in the classroom (Quezada & Allen, 2007). Beyond their own classroom, participants reached other students by founding after school clubs (Cook, 2009) and developing curriculum for their district (Evans, 2004).

## **Summary**



Global readiness includes the literacies, competencies, and dispositions students need in order to participate, collaborate, and work effectively and peacefully with anyone in the world from anywhere in the world. Students must be both multiliterate and global citizens. As Hansen (2010a) described, we must “reside in the conjunction *and*” (p. 23). If our students are going to solve the major problems of the world, our students must embrace the *and*. They must critically reflect on the past *and* design a new social future. Both educational cosmopolitanism and pedagogy of multiliteracies empower students to design and create their own social future through critical literacy. Both are open to change and see culture as constantly evolving. Educators must work through the tensions to allow for old *and* new; local *and* global; private *and* public; particular *and* universal; and receptivity *and* resistance. There will be times when U.S. teenagers decide to wear *H&M and* eat sushi, but that does not make them less Cherokee or less American. It merely makes them part of the global system. Students will have to navigate this global system by knowing the ethical times to fight against oppression and the times for tolerance and peace. There will be times when critically investigating and coming to an understanding of inequality inside a system will challenge local social cohesion, but only in the short term. In the long term, it is systems of inequality that are the true threat to peace. History shows that the more equity in societies, the more social cohesion (Heyneman, 2002; 2005).

Teachers must prepare students in a way that ultimately leads to social cohesion globally. Global readiness includes the literacies, competencies, and dispositions students need in order to participate civilly, collaborate effectively, and work successfully with anyone in the world, anywhere in the world. An empirically-tested teaching for global

readiness framework is needed in schools worldwide because globalization has flattened the world economy, the demands on the workforce are changing, and global issues need to be solved. We must train our teachers on teaching for global readiness in order to prepare the next generation for global readiness and global leadership.

### CHAPTER 3 – METHODS

Global education is a response to the demands of a globalized world, where economics, migration, and technology have no boundaries (Hansen, 2010a; Mansilla & Jackson, 2011; Merryfield, 2000; Pike, 2015). Education leaders are calling for teaching in K-12 schools for global readiness to prepare students, not for a global future, but a global today (North Carolina State Board of Education, 2013). Sound teaching is grounded in empirical research, but currently there is a lack of research at the K-12 level. Research has measured undergraduate students in global education programs using cultural competence scales, such as Intercultural Behavioral Assessment Indices (Ruben, 1976); Assessment of Intercultural Competence (Chen & Starosta, 2000; Fantini, 2000); Cross Cultural Adaptability Inventory (Kelley & Myers, 1992); Intercultural Sensitivity Inventory (Bhawuk & Brislin, 1992); and the Intercultural Development Inventory (Hammer, Bennett & Wiseman, 2003), among others.

At present, few studies have examined in-service K-12 teachers. What studies have been conducted utilize qualitative methods or general teaching scales. Scales to measure teachers' general attitudes and behaviors include the Teacher Efficacy Scale (Gibson & Dembo, 1984); Teacher Locus of Control Scale (Hall, Smitley, Villeme & Schwartz, 1980); Wilson's Stress Profile for Teachers (Luh, Olejnik, Greenwood, & Parkay, 1991), and Norland and Heimlich's Teaching Values Scale (Heimlich & Norland, 1994). A narrower scale utilized in available academic research is the Teacher Multicultural Attitude Survey (Ponterotto, Baluch, Greig, & Rivera, 1998) and the Acceptance of Global Education Scale for social studies teachers (Bingham, 1979). Currently, no instrument exists to measure

teaching for global readiness for in-service teachers. This scale development project was intended to fill this gap.

### Research Design

In order for research to be valid, the instruments employed must be valid (American Psychological Association, 2014). As Hinkin (1998) states, “It is crucial that the measures on these survey instruments adequately represent the constructs under examination” (p. 1). I used a sequential exploratory mixed methods design (QUAL → quan) to develop the teaching for global readiness scale and utilized established psychometric standards (American Psychological Association, 2014; Benson & Clark, 1982). The qualitative portion was conducted first and held a primary position because the quantitative portion was dependent on the qualitative data. The qualitative phase consisted of the divergent phase and the first round of the convergent phase (Cronbach, 1982). The quantitative segment consisted of the final rounds of the convergent phase. The purpose of the divergent phase was to consider multiple perspectives. The purpose of the convergent phase was to simplify the construct by looking at the common practices across participants. Figure 3.1 displays the sequence. A full design diagram is in Appendix A.

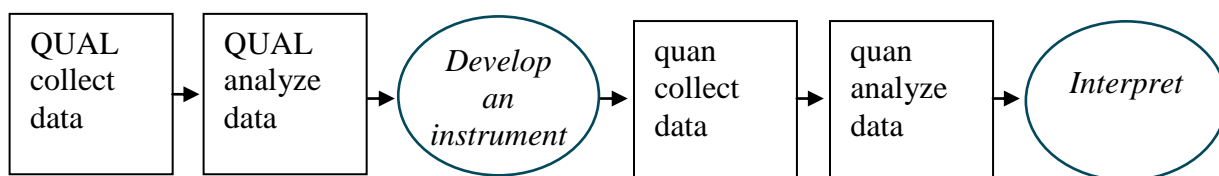

Figure 3.1. Teaching for global readiness mixed methods scale development design diagram.

This study answered five research questions. The overarching question for this study was

- How can we operationalize teaching for global readiness?

There were four sub-questions for this study.

- What did global education experts believe were the components of teaching for global readiness at the K-12 level? (QUAL)
- What are the factors of the construct teaching for global readiness? (quan)
- Are the themes about teaching for global readiness from the qualitative findings generalizable to a sample of a population of K-12 teachers? (MM)
- To what extent did the quantitative results confirm the qualitative findings? (MM)

Because these questions ask “what” and “how,” a mixed methods approach was selected, as this type of inquiry is well-matched for answering “what” and “how” types of questions (Creswell & Clark, 2011). The rationale for the mixed methods design is described next followed by sections describing the procedures and rationale for the qualitative phase and then the procedures and rationale for the quantitative phase.

Mixed methods research is becoming more widely used in the social sciences as it combines the strengths of both qualitative and quantitative methods (DeCuir-Gunby, 2008; Johnson & Onwuegbuzie, 2004). Although mixed methods is defined by researchers in different ways. Johnson, Onwuegbuzie, and Turner (2007) conducted a study to move toward consensus on a definition. Their concluding definition states:

Mixed methods research is the type of research in which a researcher or team of researchers combines elements of qualitative and quantitative research approaches

(e.g., use of qualitative and quantitative viewpoints, data collection, analysis, inference techniques) for the broad purposes of breadth and depth of understanding and corroboration. (p. 123)

Mixed methods researchers collect a variety of data types and use different analysis techniques so that the amalgamation minimizes any weaknesses inherent in singular traditions (DeCuir-Gunby, 2008; Onwuegbuzie & Johnson, 2006). Specifically, mixed methods are well-suited for instrument design (Benson & Clark, 1982; DeCuir-Gunby, 2008; Vogt, King, & King, 2004). Together the quantitative and qualitative samples provide the narratives and the numbers to produce breadth and depth of data. I chose mixed methods because it enabled both comprehensive and generalizable meta-inferences (Onwuegbuzie & Johnson, 2006). In exploratory sequential design, the qualitative phase comes first because it answers research questions such as *what is the nature of a construct?* and *how was it perceived by participants?* (Creswell, 2013; Denzin & Lincoln, 2005). The qualitative phase began the exploration with interviews in order to listen to participants. In this chapter, I will explain the qualitative and quantitative procedures utilized to develop a valid and reliable scale to measure teaching for global readiness.

### **Qualitative Phase**

The first step in instrument development is to define the construct that is to be measured (American Psychological Association, 2014; Hinkin, 1998). The construct under investigation was *teaching for global readiness* in the U.S. K-12 context. In an exploratory research design, the hypothesized definition does not come first. Instead, the participants' views come first. Qualitative inquiry examines a construct in a holistic way, permitting

researchers to hear the voices and stories of those who experience the construct as well as the evidence of those who study the construct (Lincoln & Guba, 2000; Vogt, King, & King, 2004). This allows the researcher to consider practitioner and researcher views of the construct.

**Participants.** For the first part of the study, I interviewed 24 experts. Creswell (2013) recommends 20 to 30 participants for grounded theory research, the highest sample size recommendation in qualitative research. Since the exploratory phase was similar in its objective to grounded theory research, 24 was considered an acceptable sample size. Interviewing experts is an essential step to increasing content validity of instruments (Messick, 1995). Experts can be defined as researchers of the construct or members of the target population who have direct experience with the construct (Vogt, King, & King, 2004). Teachers' voices were important to capture, for me, because one goal of my research was to empower teachers. I believed and continue to believe, as Eisner (1991) did, that the voices of teachers are powerful, are missing, and are needed in educational research. This belief led me to choose to interview current K-12 classroom teachers in addition to global education researchers who are professional teacher educators.

In order to garner diverse and credible perspectives, I used purposeful sampling (Creswell, 2013). I purposefully selected the sample for maximum variation in demographics to include expert teachers from the Global North, South, East, and West; multiple gender, ethnic, and racial identities; as well as a variety of grade levels and content areas. Expert teachers were recruited through 4 the World, an international education organization that provides professional development to teachers; NC Department of Public

Instruction Global Ready Designation Committee; and the New Literacies and Global Learning College of Education master's degree program at North Carolina State University that contextualized learning in a global society. Experts from these institutions had the depth of understanding and experience to provide rich information and reflect the North, South, East, and West perspectives desired for this study as well as experience with U.S. education to contextualize the construct to the U.S. All participants were recruited through email. From there, I continued purposeful sampling until I reached data saturation. Parameters for inclusion as an expert were (a) K-12 classroom teaching experience of at least three years and (b) global education professional development or university coursework of at least three credit hours. Participants are described in Table 3.1. I recruited participants through a personal email invitation and promised a \$30.00 gift card. Recruitment letters for teachers and teacher educators are in Appendix B.

Table 3.1.

*Table of Participants for the Exploratory Qualitative Interviews*

Name	Race	Sex	Credentials	Current position	Grade level	Personal global experiences	Professional global experiences
Jess	Asian	f	M.Ed.	Research assistant	9-12	Intl vacations, bilingual	Graduate study abroad, global learning course, global project collaboration
Jan	White	f	M.Ed., NBCT	Teacher	6-12	Intl vacations	PD Abroad, culturally relevant teaching course



Table 3.1. (continued)

Name	Race	Sex	Credentials	Current position	Grade level	Personal global experiences	Professional global experiences
Graham	White	f	M.Ed., NBCT	Teacher	6-8	Hosted exchange students, Intl service	Student teaching abroad, PD abroad
Francis	White	f	M.Ed., NBCT	Teacher	K-5	n/a	PD abroad, global learning course
Kelly	White	f	M.A.	Teacher	9-12	Intl service	Led trips abroad for students, PD abroad
Coral	African American	f	M.Ed.	Teacher	K-12	Bn/a	Global learning course, PD abroad
Veronica	White	f	M.Ed.	Teacher	6-12	Intl vacations	Global learning course, global project collaboration, intl conference
Lawrence	White	m	M.Ed.	Teacher	K-5, 9-12	Global experiences course	AP World history training
Hannah	white	f	M.Ed.	Teacher	6-8	Intl vacations, study abroad	Global project PD, IB training
Megan	White	f	M.Ed.	Teacher	6-8	Intl vacations	IB training
Heidi	White	f	M.Ed.	Teacher	K-5	Intl vacations	Courses in global learning
Sofia	Hispanic	f	B.A.	Teacher	K-5	Bilingual	Work with international education NGO
Alma	Hispanic	f	B.A.	Teacher	K-5	Bilingual	Work with international education NGO
Paulo	Hispanic	f	B.A.	Teacher	K-5	Bilingual	Work with international education NGO

Table 3.1. (Continued)

Name	Race	Sex	Credentials	Current position	Grade level	Personal global experiences	Professional global experiences
Marco	Hispanic	m	B.A.	Teacher	K-5	Studied abroad, bilingual	Work with international education NGO
Nick	Asian	m	M.Ed.	Teacher	K-5	Intl vacations, bilingual	Global learning course, study abroad
Ning	Asian	f	M.Ed.	Teacher	K-5	Intl vacations, bilingual	Global learning course, study abroad
Joy	Asian	f	M.Ed.	Teacher	6-8	Intl vacations, bilingual	Global learning course, study abroad
Natalie	African American	f	M.Ed.	Admin	K-12	Intl vacations	Founded intl theme school
Justin	White	m	Ed.D.	Admin	K-12	Intl service	Taught abroad
Nichole	White	f	M.Ed.	Admin	K-12	Intl vacations	Global ed administrator, intl conferences
Helen	White	f	Ph.D.	Teacher educator/ Researcher	9-12	Studied abroad	Taught abroad, researches global education & internationalization of teacher education
Carmen	White	f	M.Ed., NBCT	Teacher educator/ Researcher	K-5, middle, high	Studied abroad, intl vacations, hosted exchange students, bilingual	Led study abroad
Lucas	White	m	Ph.D.	Teacher educator/ Researcher	6-8	n/a	Taught global learning, led intl PD

**Data collection.** Qualitative data comprised two sources: expert interview transcripts and researcher notes. I used a researcher-generated semi-structured interview protocol of nine open-ended questions with additional probes (Creswell, 2013; Fontana & Fey, 1994). Fontana and Fey (2003), experts on interviewing, recommend asking each participant the same questions in instrument development to give optimal data from each participant in the study. I strove for questions that were clear and not leading to the participants. The protocol is provided in Appendix C. Expert interviews were one-on-one with 24 K-12 global teachers, administrators, and teacher educators. I audio recorded all expert interviews that were permitted by the participants ( $n = 22$ ) and transcribed verbatim. Extensive researcher notes including en vivo quotations were taken of the two interviews not audio recorded. During and after all interviews, I took notes on participants' statements and artifacts observed in participants' classrooms, such as international maps and posters of Chinese art.

**Data analysis.** I employed NVivo software for qualitative data management and analysis. The verbatim interview transcripts first were analyzed using an iterative six-phase thematic analysis process (Braun & Clarke, 2006). First, I read and reread the transcripts to immerse myself in the data. Keeping the research questions in the forefront, I highlighted key statements and created nodes summarizing each statement into an answer. Second, I generated categorical codes across the data. The initial codes were a priori based on the four dimensions of pedagogy of multiliteracies and the four dimensions of educational cosmopolitanism. (Refer to Figure 1.2 for the eight dimensions.) For key statements that did not directly align with the theoretical framework, I generated en vivo codes. Third, I compared and contrasted codes looking for patterns to become themes and gathering like

data together in a matrix (Corbin & Strauss, 1990; Onwuegbuzie & Leech, 2006). Fourth, I reviewed the themes for internal homogeneity and external heterogeneity (Braun & Clarke, 2006). Then, I reviewed the data to make sure the themes were comprehensive of the construct based on the literature and supported by the data based on participants' contexts. Finally, I "refined and defined" the themes by constantly comparing the data to the codes and to the themes until the themes were exhaustive, internally consistent, and mutually exclusive (Braun & Clarke, 2006, p. 92; Corbin & Strauss, 1990). See Table 3.2.

Table 3.2.

*Themes, codes, and nodes from qualitative analysis.*

Theme	Categorical Code	Node
Integrated*	Whole child approach*	Considering academic, social, cultural, & personal growth Building cultural knowledge of students
	Overt instruction	Intentional instruction on global issues Setting and assessing global learning goals* Scaffolding global learning*
Situated practice	Hospitality	Tolerating difference Building relationships with students and parents
	Situated practice	Building partnerships with the international community* Creating community of learners
	Relevant content*	Relating current events* Connecting with real people*
Critical framing	Critical literacy*	Supporting critical thinking Advancing communication skills
	Reflexivity	Promoting students' introspection Reflect on own biases and assumptions Encouraging questioning
	Critical framing	Reducing stereotypes

Table 3.2. (Continued)

Theme	Categorical Code	Node
Transactional experiences	Intercultural dialogue	Providing firsthand experiences*
	Transactions of perspectives	Design international collaborations* Providing multiple perspectives
	Transformed practice	Promoting equality Facilitating student-centered learning* Supporting creative thinking

Note: \*en vivo coding

Key quotes from the data became potential scale items, nodes became variables, and themes became subscales (Creswell & Clark, 2011). This means that the four dimensions of educational cosmopolitanism and the four dimensions of multiliteracies were included in the potential scale. After analysis, there were 84 potential items, 24 variables (e.g., *design international collaborations*, *assess students' global learning*, and *reflect on own biases and assumptions*), eight categorical codes (i.e., the middle row in Figure 3.2), and four themes (i.e., the top row) for the construct teaching for global readiness.



Figure 3.2. Themes and categorical codes for the construct *teaching for global readiness*.

**Validity and reliability.** Denzin and Lincoln (2005) use the terms *truthfulness* and *trustworthiness* to describe techniques comparable to validity and reliability measures in quantitative research. However, mixed methods researchers often use the terms *validity* and *reliability* for both portions (DeCuir-Gunby & Schutz, in press). To increase validity and reliability, I followed rigorous qualitative inquiry methods throughout the duration of the study, including triangulation, member checking, and detailed reporting (Creswell & Clark, 2011). Triangulation was achieved by using more than one participant's statements to corroborate the findings. Vogt, King, and King (2004) strongly suggest that members of the target population review and provide feedback on the content validity and job relevance of the instrument before official release. After analysis, I conducted member checks with all

participants by sending the dimensions and operational definitions as well as a short narrative description through email. Eleven participants responded with positive comments, such as “Looks great” and “I am very glad to see these issues are addressed in a holistic way” and “It's really interesting to see what I think and do put into a formal framework. This is so reflective of my thoughts and instruction, the other teachers that you interviewed must have had several ideas/practices similar to mine in many ways.” No participants responded with negative feedback or suggestions to improve accuracy. Also for validity and reliability, I committed to describing the data using rich, thick details including reports of disconfirming evidence if manifest (Creswell, 2013).

As bell hooks (*sic*; 1994) reminds us, our backgrounds have shaped “the biases that informed the way knowledge would be given and received” (p.178). In other words, I could sympathetically listen and systematically observe but my own biases will always shape the truth that I heard and saw in both the qualitative and quantitative portions. Education researchers recommend reflexivity procedures to increase validity (Creswell & Clark, 2011). To bracket my assumptions, I kept a researcher journal before and during the study. To minimize my own biases, I analyzed verbatim interview transcripts, utilized a peer coder for a random sample of the data, and performed peer-debriefing sessions (Onwuegbuzie & Leech, 2007). Peer coding and peer debriefing provided a qualitative form of inter-rater reliability to ensure reliability of the study as a whole.

### **Quantitative Phase**

The quantitative portion of the study depended upon the findings of the qualitative portion. The following section describes the participants and the procedures for the second

part of the construct testing process. The quantitative phase began with development of the instrument.

**Instrument development.** Survey design and implementation followed rigorous psychometric procedures (American Psychological Association, 2014; Groves et al., 2009; Hinkin, 1998; Tourangeau, Conrad, & Couper, 2013). The survey included demographic questions, the teaching for global readiness scale (TGRS), and the global competence subscale from the global citizenship scale (Morais & Ogden, 2011). The quantitative TGRS was created based on the qualitative analysis of phase one and existing instruments. The global citizenship subscale was administered in conjunction with the newly developed TGRS to test the scale for convergent validity (Groves et al., 2009; Hinkin, 1998). The global citizenship scale was validated by Morais and Ogden (2011) with undergraduate students as participants and sample items appear in Appendix D. The authors reported acceptable Cronbach's alpha for each factor tested by confirmatory factor analysis (ranging from 0.69 - 0.92) and acceptable goodness of fit ( $\chi^2 = 465.64$ ,  $\chi^2$  to  $df = 1.18$ , CFI = 0.98, NNFI = 0.98, RMSEA = 0.03, SRMR = 0.07).

**Item generation.** I wrote a large pool of 84 items based on the qualitative data, existing instruments in the literature, and the psychology of survey response (Tourangeau, Rips, & Rasinski, 2000). Quotes from the qualitative portion became items. Items were also adapted from the Globally Competent Teaching Continuum (Parkhouse et al., 2015) and Global-Ready Teacher Competency Framework: Standards and Indicators (VIF International as cited in Partnership for 21<sup>st</sup> Century Skills, 2014), both qualitative instruments, as well as the Global Citizenship Scale (Morais & Ogden, 2011) and the Teacher Multicultural Attitude



Survey (Ponterotto, Baluch, Greig, & Rivera, 1998), both quantitative instruments. To strike the balance between thorough representation of the construct and parsimony as recommended by Thurstone (1947), my intent was to retain four to six items per factor (Costello & Osborne, 2005). Hinkin (1998) advocates generating “at least twice as many items as will be needed in the final scales” in order to adequately sample from the true construct domain (p. 110). For the response format, the 1-5 Likert scale *strongly disagree* to *strongly agree* was utilized because of its familiarity, which tends to reduce the cognitive burden on participants (Stone, 1978). Statements intended to measure frequency of teacher practices were written on a 1-7 scale as *never*, *less than once a month*, *once a month*, *two to three times a month*, *once a week*, *two to three times a week*, and *daily*. The 1-7 scale tends to offer optimal statistical variance and because the items were regarding frequency, more choices tend to not increase cognitive burden (Stone, 1978). Further, a Likert scale is considered the best rating scale for factor analysis (Hinkin, 1998). The 84 potential items appear in link provided in Appendix E.

***Content validity.*** Content validity assessments serve as a test of conceptual consistency of each item. The content validity process requires the researcher to provide construct definitions so that others can qualitatively judge each item in relation to the construct under examination (Hinkin, 1998). The face validity trial approach to content validity assessment was recently utilized by Morais and Ogden (2011). Using this approach, the 84-item pool was sent out to education experts to judge each item for relevance and quality. Education experts were originally identified from the literature and recruited by email through a snowball sample. Twenty-two expert reviewers participated in the trial with

a 92% completion rate. The expert review was conducted to determine whether the subscale each item was intended to measure was the subscale subject-matter experts actually identified (Morais & Ogden, 2011). Only items that were consistently identified at a minimum agreement of 60% were retained. Results appear in Appendix E. The remaining 39 items were reviewed for coverage of all four themes. Redundant items were deleted (i.e., *I promote critical thinking* was deleted and *I teach critical thinking* was kept; *I select materials for my class based on relevance to current global issues* was deleted and *I select materials for my class based on relevance to real world issues* was kept; *I am aware of the different cultures in my classroom* was deleted and *I take inventory of the cultures represented by my students* was kept; and *I teach global content* was deleted). The remaining 36 items were reviewed for parallel structure and consistent wording as shown in the following table.

Table 3.3.

*Potential Items for Teaching for Global Readiness Scale*

Potential Items	Themes			
	Situated	Integrated	Critical	Transactional
How often do you...				
Use inquiry-based lessons about the world.			C.1	
Use texts written by authors from diverse countries.		I.1		
Use class materials based on real world issues.	S.1			
Differentiate instruction to meet learners' diverse needs.	S.2			

Table 3.3. (Continued)

Potential Items	Themes			
	Situated	Integrated	Critical	Transactional
Integrate global learning experiences with the existing curriculum.		I.2		
Design international collaboration projects for my students.				T.1
Keep informed on global issues		I.3		
Reflect on own assumptions and biases.			C.2	
Adapt my teaching methods to meet the needs of a culturally diverse student group.	S.3			
Integrate international current events with the curriculum.		I.4		
Facilitate conversations between my students and students from other countries.				T.2
Teach critical thinking skills.			C.3	
Teach cross-cultural communication skills.				T.3
Provide students with more than two perspectives on global issues so that they do not see the issue in a polarized way.			C.4	
Bring in speakers from different backgrounds so that students can listen to different perspectives.				T.4
Take students on field trips to international places within the community (e.g., mosque, Asian market, Japanese garden).				T.5
Assess global learning.		I.5		

Table 3.3. (Continued)

Potential Items	Themes			
	Situated	Integrated	Critical	Transactional
How often do you ask students to...				
Read/view international sources.		I.6		
Critically analyze the source of information.			C.5	
Analyze content from multiple perspectives.			C.6	
Engage in critical discussions about international current events.			C.7	
Construct claims based on primary sources.			C.8	
Share their culture with other students.				T.6
Utilize technology (e.g., Skype, email) for virtual interviews (with experts, community members).				T.7
Utilize synchronous technology (e.g., Skype, Google Hangout, FaceTime) for international collaboration.				T.8
Utilize asynchronous technology (e.g., email, blogs) for international collaboration.				T.9
Conduct content-aligned investigations of the world.		I.7		
During a typical semester . . .				
I build a repertoire of resources related to global education.		I.8		
I cultivate a classroom environment that values diversity.	S.4			
I take inventory of the cultures (languages, countries, etc.) represented by my students.	S.5			

Table 3.3. ( Continued)

Potential Items	Themes			
	Situated	Integrated	Critical	Transactional
I guide students to examine other possible perspectives.			C.9	
I guide students to examine their own cultural identity.			C.10	
I provide a space that allows learners to take risks.	S.6			
I am informed through international sources.		I.9		
I teach my students to analyze the agenda behind media messages.			C.11	
I display artifacts (e.g., maps, posters, souvenirs) from other countries in my classroom.		I.10		

In order to help participants comprehend and answer the questions accurately, survey designers need to understand the cognitive processes used to answer questions: comprehension, retrieval, judgment, and formulation of response (Tourangeau, Rips, & Rasinski, 2000). This process is illustrated in Figure 3.3. When writing the survey, I utilized the language of the target population, wrote specific items and specific responses, and include definitions if necessary, as all improve the accuracy of survey response (Tourangeau, Rips, & Rasinski, 2000).

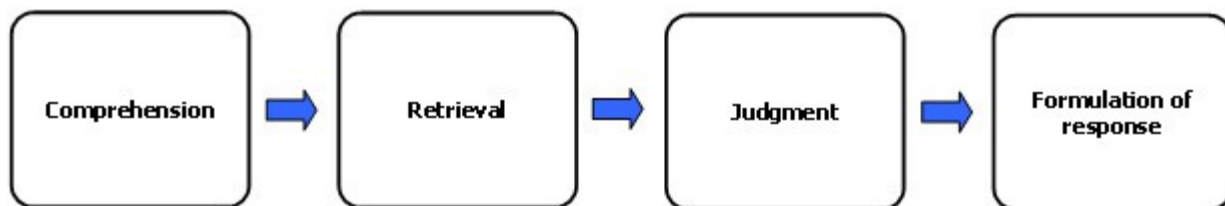

Figure 3.3. Four cognitive processes used in responding to survey items. Adapted from *The Psychology of Survey Response*, by R. Tourangeau, L. J. Rips and K. Rasinski, 2000, New York: Cambridge University Press.

Cognitive interviews can help reduce measurement error and increase validity by checking the clarity and quality of the survey items and responses (Groves et al., 2009; Willis, 2005). After the instrument was drafted, I conducted cognitive interviews to investigate the mental processes involved in reading, comprehending, deciding, and responding to the instrument directions and items. The purpose of the interviews was to identify problem areas with wording or design before distributing the instrument. I utilized four techniques to garner feedback: observation, think-aloud, probing, and questioning (Groves et al., 2009; Willis, 2005).

The interviews were conducted with a small sample of convenience ( $n = 6$ ) of the target population who provided knowledgeable feedback about the topic, items, responses, and format of the instrument (Gordon, 1999). Interviewees included elementary, middle and high school teachers and covered the core subjects of English, mathematics, social studies, and science. The six interviews took place individually as they completed the online survey. I asked questions and noted comments throughout the duration of the survey. Cognitive

interviews were conducted according to Willis's (2005) protocol. Think aloud probes and questions included:

- Can you repeat the question in your own words?
- What does the term mean to you?
- Tell me what you are thinking (when the participant pauses).
- Was that question easy or difficult?
- How do you remember what you have taught in a typical semester?
- How did you arrive at that answer?
- How sure are you of that answer? Why?

Because the instrument was planned as part of a web-based survey, I also used the cognitive interviews to test the skip logic, jumps, and links within the survey responses. At the end of the survey, I conducted a debriefing session asking the interviewees to look at the operationalized definitions and graphic organizer (in Appendix G) and tell me if the survey covered all of the aspects. I also asked interviewees to give me advice on how to make the survey clearer and more relevant to K-12 teachers. By treating instrument development as an iterative process, I minimized measurement error.

Necessary revisions to instructions, items, and response options were made before administering the instrument to the study sample. Interviewees believed that the 7-point Likert scale for agreement was too burdensome but that 7-point for frequency was appropriate. One item was considered double-barreled and split into two in order to ask about students' conversations about their own cultures as well as connections to other countries. Interviewees also felt that promoting equality and breaking down stereotypes were

not inherent to any items, so those variables were added as separate items. The result was a 40-item proposed scale for teaching for global readiness with nine items for *situated practice*, eleven items for *integrated global learning*, eleven items for *critical framing*, and nine items for *transactional experiences*. Additional items written are displayed in Table 3.4.

**Mode.** The scale was part of a web survey. Modes differ in how they are perceived by respondents in that the levels of interaction and privacy are very different between a face-to-face interview and an anonymous web survey. While face-to-face and paper surveys often have better response rates in research on the general public, I chose web surveys because they are more economical and efficient and because the target population for the survey, K-12 teachers, uses the internet as part of their professional duties, so they have adequate access and experience using the internet (Tourangeau, Conrad, & Couper, 2013). In addition, while the items were not likely to be perceived as of a sensitive nature, items could be influenced by social desirability. The issue of social desirability occurs when the respondent perceives that there is a socially acceptable answer and this bias causes the respondent to answer differently from the truth. Web surveys are more private and therefore the influence of social desirability is lessened (Tourangeau, Conrad, & Couper, 2013).



Table 3.4.

*Additional Potential Items Added to Teaching for Global Readiness Scale*

Additional Potential Items	Themes			
	Situated	Integrated	Critical	Transactional
I cultivate a classroom environment that promotes equality.	S.7			
I attempt to break down students' stereotypes.	S.8			
I provide a space that allows students a voice.	S.9			
I facilitate conversations about connections between my students and other countries.		I.11		

**Sample.** In education research, a common criterion for determining adequate sample size is based on the participant-to-item ratio of 10:1, but recent evidence does not support this rule of thumb (Costello & Osborne, 2005). Gaskin and Happell (2014) advocate for using multiple criteria for minimum sample size requirements, including criterion that takes into account the communalities. However, communalities cannot be assessed until after a sample has been drawn. Therefore, in order to make the best estimation, I utilized multiple criteria beforehand: Gaskin and Happell's (2014) minimum sample size for factor analysis criteria, participant-to-item ratio ( $> 10:1$ , Nunnally, 1978), participant-to-variables ratio  $\geq 3:1$  if variable-to-factor ratio is  $\geq 3:1$  (Cattell, 1978), and minimum number of participants ( $n = 200$ , Hinkin, 1998). I calculated minimum number requirements for two separate samples. These two samples will be described next.

Two different samples should be used for scale development and testing psychometric properties to ensure that results are not sample-specific (Hinkin, 1998). Participants for two samples were recruited through VIF International, an NC-based agency that provides global education training for teachers. The purpose of the factor analysis was not to generalize to a larger population nor to compare populations but instead to validate a construct, so random sampling was not necessary (Comrey & Lee, 1992). Over 3,350 US K-12 educators were part of the VIF network. The network was diverse demographically and geographically; however, they all were K-12 classroom teachers from all content areas in the U.S. with global personal or professional experience. Both of these aspects allowed for desired levels of representativeness of the target population and variability around the factors that were needed to enhance the statistical analyses, with variability within the construct being the essential component of samples for exploratory purposes (Comrey & Lee, 1992; Hinkin, 1998).

Recruitment protocol for the quantitative samples included three waves (Messer & Dillman, 2011) utilizing the tailored design method (Dillman, Smyth, & Christian, 2008). The tailored design method for web surveys suggests that the researcher:

- Personalize contacts attending to sender name, address, and subject line;
- Contacts multiple times with varying messages;
- Send timed contacts;
- Use short emails;
- Avoid spam filters by sending in small numbers;
- Provide clear instructions for access;

- Assign unique identifications;
- Establish procedure for bounced emails and respondent inquiries;
- Monitor progress and evaluate early completes;
- Provide tokens of appreciation.

Recruitment of participants took place in three waves: (a) personalized email announcement, (b) personalized email with unique link, and (c) personalized follow-up reminder emails (Dillman, Smyth, & Christian, 2008). In the first email, I described the purpose of the study, explaining how it would benefit teachers. In the second email, I notified participants of the unique link they could use immediately to take the web-survey on Qualtrics. After 14 days and after 17 days, I sent an email reminder to nonrespondents. The respondents were entered into a lottery for a \$200 gift certificate to Amazon for completing the survey. Previous research indicates that prepaid over promised has no impact on web survey (Bosnjak & Tuten, 2003) and that lottery for a large sum rather than no lottery or multiple sums has a small but positive impact (Bosnjak & Tuten, 2003; Göritz & Luthe, 2013; Göritz & Wolff, 2007; Laguilles, Williams, & Saunders, 2011). The survey remained open for participants for three and a half weeks with winter break from school occurring during that time.

**Data analysis.** According to test theory, the process of validating a hypothesized construct consists of two analysis phases. The first phase is divergent. The researcher develops and expands theory by gathering possible dimensions from a broad range of sources. Sources should include stakeholder values, professional standards, theoretical frameworks, expert knowledge, and researcher judgment (Cronbach, 1982; Vogt, King, &

King, 2004). In the second convergent phase, the researcher selects and refines the specific indicators for the instrument based upon the findings of the divergent phase data (Hinkin, 1998; Vogt, King, & King, 2004). The convergent phase combines the qualitative and the quantitative data analysis. Figure 3.4 illustrates my instrument development and assessment process.

Once the survey was closed, the respondents were randomly split in half to form the two samples. Basic descriptive statistics were conducted to summarize the data for each sample. I determined the mean, median, standard deviation, and confidence intervals. The steps for exploratory factor analysis included calculating correlations, extraction of factors, factor rotation, and interpretation. Inter-item correlation and item-to-total correlation were analyzed using Kaiser-Meyer-Olkin (KMO) and polychoric correlation. KMO was assessed to determine sampling adequacy, or whether the sample of items was adequate for factor analysis. I conducted principal axis exploratory factor analysis with orthogonal varimax rotation to determine which items grouped together. Factor loading is the correlation of an item to a factor. Factor loadings of .55 or higher are considered good and .45 to .54 are considered fair (Comrey & Lee, 1992). Items with small standard deviations, low item to total correlation, loading on multiple factors, or low factor loading were eliminated so that the end product was a valid and reliable scale.



*Figure 3.4.* Instrument development design process. Adapted from “A Brief Tutorial on the Development of Measures for Use in Survey Questionnaires,” by T. R. Hinkin, 1998, *Organizational Research Methods, 1*, p. 109.

**Validity and reliability.** The validity of the conclusions drawn from a study depends upon the validity of the instrument used in the study (Hinkin, 1998; Groves et al., 2009; Vogt, King, & King, 2004). This section discusses potential errors related to validity and the process of construct validity. Measurement error and unclear constructs are observational errors. Groves et al. (2009) defines observational errors as “deviations from answers given to

a survey question and the underlying attribute being measured” (p. 40). Careful survey design can reduce observational error.

**Measurement error.** Two types of measurement error are *response bias* and *response variance*. Response bias refers to systemic underreporting or over-reporting across a survey. For example, researchers have found that respondents underreport socially undesired behavior such as illicit drug use (Groves et al., 2009). Response bias leads to stable overestimation or underestimation. In contrast, response variance refers to unreliable responses. Examples include when the same respondent would answer the same question differently on different applications of the survey or the respondent answers carelessly, as can be a problem with web surveys (Meade & Craig, 2012).

Design can help participants chose the optimal response by (a) limiting the number of response categories while giving enough to have statistical differentiation, (b) being careful to use memory cues but not priming for a particular response, (c) avoiding social desirability by ensuring confidentiality and de-identification, and (d) allowing participants to take the survey in private rather than in public at school (Tourangeau, Rips, & Rasinski, 2000). To reduce measurement errors and reduce bias, I utilized psychology of survey response to write questions, as described above. Data cleaning can also reduce measurement error. Prior to analysis the data sets were screened for careless responding and missing items (Meade & Craig, 2012). Missing data were analyzed for randomness and each item determined to be suitable (Osborne, 2012). The longest string method was utilized for identifying and removing careless responding with a cutoff value of 10, based on the clear breakpoint in the frequency distribution (Johnson, 2005). One string of 16 was found but after careful

examination, the data were kept as the answers before and after the string were varied. When cleaning the data, I was cognizant of the ethical consequences of deleting cases and took great measures not to delete cases when possible.

***Construct validity and instrument reliability.*** In order to ensure that the instrument measured the construct it was intended to measure, statistics of construct validity were conducted. Exploratory factor analysis (EFA) and confirmatory factor analysis (CFA) were conducted on the instrument data to measure validity. Internal consistency and goodness of fit statistics were tested for reliability and significance by following best practices (Clark & Watson, 1995; Kim & Mueller, 1978; Schmitt, 2011).

The survey was administered to 3,354 VIF International K-12 classroom teachers with a 19% response rate. All data were determined adequate with a total sample of 630. VIF International teachers are a diverse group demographically from the U.S. and all over the world. However, they all were K-12 teachers presently in the U.S. with professional global experience. These characteristics allow for variability within the target population that enhanced the EFA. To enhance external validity, the sample was examined through histogram and t-tests of mean difference. Visual analysis of the histogram led to division of the sample into early responders as December 12 - 31 ( $n = 270$ ) and late responders January 1 - 16 ( $n = 352$ ). T-tests were performed on the strongest variable (i.e., utilize synch tech, promote equality, analyze multiple points of view, and integrate global learning) in each factor by month. The differences of means between December and January responders were not different from zero, suggesting no significant differences in variances across groups. Statistics can be found in Appendix H.

Respondents represented a broad range of experience teaching and subjects taught. Respondents' states ranged from Hawaii to Maine, however the majority of participants were from North Carolina. Full demographics are specified in Table 3.5. The data from the sample were randomly split in two groups using excel random function ( $n = 341$ ,  $n = 289$ ).

Table 3.5.

*Table of Quantitative Participants*

Professional experience and demographics	Number of respondents	Percentage of respondents
Grade level taught		
K-5	370	66
6-8	111	20
9-12	80	14
Subject taught		
All	183	27
ELA/Literacy	102	15
ESL	15	2
History/SS	67	10
Mathematics	71	11
Science	69	10
PE/Health	17	3
Arts	33	5
World Languages	27	4
Career and Technical	26	4
Other	20	3



Table 3.5. (Continued)

Professional experience and demographics	Number of respondents	Percentage of respondents
Years of teaching experience		
0-4	100	18
5-9	106	19
10-14	108	19
15-19	95	17
20 or more	154	27
Highest degree attained		
Bachelors	280	50
Masters	270	48
Doctorate	11	2
Gender		
Female	474	85
Male	79	14.5
Other gender identity	2	.5
Race		
African-American/Black	62	11
Asian	11	2
Hispanic	37	7
Native American	7	1
Pacific Islander	0	0
White/Caucasian	413	75
Multiracial	12	2
Other racial identity	12	2

The first half was assessed using exploratory factor analysis with principal axis orthogonal varimax rotation (Gaskin & Happell, 2014; Kim & Mueller, 1978; Sass & Schmitt, 2010). As the data were ordinal, polychoric correlations were run (Gaskin & Happell, 2014). The sample was assessed with the Kaiser, Meyer, and Olkin (KMO) test to determine adequacy to yield discrete and reliable factors (Field & Zoe, 2012). Both the Kaiser criterion (i.e., eigenvalues over 1.0 kept; Kaiser, 1960) and a scree test (Cattell, 1966)

were used to determine the number of factors (Costello & Osborne, 2005; Gaskin & Happell, 2014). In the next step, rotation was conducted to simplify and clarify the structure. Oblique rotation was considered, but orthogonal varimax rotation offered a better fit (Costello & Osborne, 2005; Gaskin & Happell, 2014). EFA also tests the individual items enabling reduction of the number of items to keep the survey as short as possible for participants. Shorter surveys have less break-off than longer surveys, which reduces missing data and increases validity (Dillman, Smyth, & Christian, 2008). Cronbach's alpha was used to analyze the internal consistency for items within each subscale. Values above .70 are considered to have high reliability for exploratory measures (Nunnally, 1976).

Once items were reduced, the data were then analyzed with CFA to confirm unidimensionality and to test whether the overall model was significant (Hinkin, 1998). The chi-square test was used for the goodness of fit statistic at the 0.05 level. However, the chi-square statistic can be sensitive to sample size, so other measures that are more heavily relied upon in the literature were also employed (Brown & Moore, 2015). Goodness of fit was evaluated using the following criteria: (a) chi-square statistic; (b) ratio of chi-square to degrees of freedom less than two (Hair, Anderson, Tatham, & Black, 1995; Hooper, Coughlan, & Mullen, 2008); (c) comparative fit index (CFI)  $\geq .95$  (Hu & Bentler, 1999); (d) Tucker-Lewis index (TLI; Tucker & Lewis, 1973)  $\geq .95$  (Hu & Bentler, 1999); (e) standardized root mean square residual (SRMR)  $\leq .07$  (Hu & Bentler, 1999); and (f) root mean square error of approximation (RMSEA)  $\leq .06$  (Hu & Bentler, 1999). Reliability using Cronbach's alpha was tested for each factor (Kim & Mueller, 1978). The process of construct validity is ongoing and will continue with future studies (DeCuir-Gunby, 2008).

**Ethical Considerations**

IRB protocol was followed to protect the rights and privacy of the participants. All participants were informed about the study and signed consent forms (see Appendix G). No direct identifiers were used in the questionnaires or in the interview transcripts. Pseudonyms were given to schools and participants to protect confidentiality of the participants.

**Summary**

This study used a sequential exploratory mixed methods design. Exploratory sequential mixed methods is the prevalent method for scale development in the sciences because it combines the strengths of qualitative, namely hearing diverse perspectives of members of the target population, and the strengths of quantitative, namely generalizable to the target population (Benson & Clark, 1982; Clark & Watson, 1995; DeCuir-Gunby, 2008). The first phase was qualitative, and relied on the assistance of construct experts. The qualitative findings were used to develop an instrument to test hypotheses related to teachers' practices about teaching for global readiness. In the quantitative phase, teaching for global readiness data were collected from K-12 teachers through VIF International. Exploratory and confirmatory factor analysis and Cronbach's alpha were evaluated to determine validity and reliability. The end product was a valid and reliable scale to measure teaching for global readiness.

## CHAPTER 4 – Qualitative Findings

This study employed a sequential exploratory mixed methods design. The first phase of the study involved collecting qualitative data through interviews with 24 expert global educators from the U.S., Belize, and China. All interviews focused on preparing students in the U.S. to be able to participate politically, interact socially, and work collaboratively on an international level. The findings of the qualitative analysis comprised four overarching themes: *situated practice*, *integrated global learning*, *critical framing*, and *transactional experiences*. In other words, teaching for global readiness is *situated*, *integrated*, *critical*, and *transactional*. The four themes are comprehensive and mutually exclusive and answer the research question: What do global education experts from around the world believe are the components of teaching for global readiness at the K-12 level? Teaching for global readiness should include all four themes but not necessarily at the same time. Many of the subthemes relate to each other as teaching in the classroom is often multifaceted. All of the themes are grounded in pedagogy of multiliteracies and educational cosmopolitanism theories. Figure 3.2 in the previous chapter illustrated the subthemes and variables categorized under each of the four overarching themes.

### **Situated Practice**

Teaching for global readiness is situated, meaning that teachers are cognizant that each lesson happens in a particular time and place and is situated culturally, socially, and historically in that time and place. Teachers must consider the context and teach in a way that is appropriate to the unique situation of each student, each group that constitutes a class,

each day, and each geographical location. Participants described adapting instruction to be responsive to the cultures in their classroom and to meet learners' diverse needs.

Situated practice is about relationships and relevance; it is about teaching real people about the real world. Two subthemes for this overarching theme are hospitality and relevance.

**Hospitality.** Hospitality includes creating a welcoming classroom environment as well as “kindness to strangers” — as one participant mentioned Appiah’s highly cited quote. Hospitable classroom environments are welcoming of all students and students’ cultures as well as open to new and different cultures. In support of the former point, hospitality involves building relationships with students and their families. One participant explained how keeping parents or guardians informed of controversial issues that will be examined in class and the rationale behind including the issues is an important precursor to critical examinations of the world. In relation to the later point, participants spoke of teaching students to see new and different cultures through a lens of tolerance and compassion, not through a lens of weirdness or disgust. Participants stated that in order to teach for global readiness, teachers would not merely tolerate difference, they would need to view diversity as valuable. Participants perceived diversity of perspectives as adding to the richness of intellectual pursuit.

Participants often described teaching for global readiness as a pedagogy that cultivates a community of learners. Participants perceived that teaching within a community of learners gives students a voice both to express their concerns and needs and to learn from each other. In this way, the teacher’s role is as facilitator in the classroom and students can

teach each other. One participant stated, “I think you can get more involved when you bring in their backgrounds and allow students to have a voice, and encourage students who are, especially, international or from other cultures to describe some of the differences in their lives.” Participants perceived tolerance for difference to be a major component of a community of learners. Another component of cultivating a community of learners is helping students to connect to each other and connect to other learners outside of the classroom. Cultivating a disposition of openness to all people was a goal participants shared. Participants reported that cultivating a classroom environment that values diversity and promotes equality is foundational to teaching for global readiness.

**Relevant.** In order to make global education relevant to each individual student, participants stated that teachers must consider the context of each class and know the backgrounds and interests of students. Participants perceived learning about other cultures to begin with the teacher taking inventory of the cultures and countries represented in the classroom and then inviting students to teach the class about their own backgrounds. One participant declared, “Every teacher has some responsibility to be ready, aware, knowledgeable, whatever it is, of the cultures that are in their school, in the community that their school serves. I think that’s just something that’s absolutely essential.” Knowing one’s students was perceived as important in order to create a hospitable classroom as well as to make learning relevant to students.

The strongest variable in this subtheme was connecting: connecting the curriculum to real world issues and the students to real people with international experience. Participants reported facilitating conversations about the connections between their own students and

other countries. Connecting the curriculum to the real world through authentic learning was mentioned numerous times and ties in with integrating international current events.

Consistently, teachers reported teaching global awareness and perspective-taking by integrating international current events into the daily lessons. (Integration will be discussed in general in the following section.) Also mentioned numerous times was connecting the students with real people that are in the community and have international experience as well as people internationally. One participant asserted, “It’s not good enough to simply read a perspective about what life is like over there, read an article, or whether it’s primary or secondary, it does not matter. We have to build these real relationships that are authentic.” Relating the curriculum to real world issues and to real people is what participants seemed to consider authentic.

### **Integrated Global Learning**

Participants unanimously stated that global issues and global learning concepts should be integrated with the standards of all classes K-12. Participants agreed that global education must be integrated into the existing standards-based curriculum for two reasons: one reason was that global education is important and the second reason was that global education is not currently part of the curriculum and assessment for all courses. Teaching for global readiness needed to be integrated because the participants perceived there was not enough time in the school year to add additional curriculum.

Participants perceived that teaching for global readiness needed to be integrated into the curriculum in a multifaceted way, including career and citizenship preparation. To participants, citizenship preparation meant that teaching for global readiness was a matter of

social importance for their students' individual successes in the future but also for social cohesion and world peace. Teaching for global readiness included teaching about local diversity as well as universal human experiences in international contexts. Teaching for global readiness included teaching about the past and also current events from multiple perspectives. Participants agreed that teaching holidays from around the world represented the most common form of global education that they observed but that this approach was not enough for global readiness because it lacked depth and complexity. One participant gave two criteria for teaching that is considered to reflect global readiness: "It's got to be deep, it's got to be authentic." A participant described the kind of multifaceted instruction that leads to global readiness as follows:

[The students] took on a cycle of exploration, problem solving, identifying different points of view, supporting your argument, discussions within the group whereby you pushed back on each other. I mean, so those are key components of a lesson that fosters global-mindedness.

Participants perceived that the need to go deep meant that teaching for global readiness could not just be taught in social studies or world languages courses but across the curriculum. English, math, science and special education teachers all felt that teaching for global readiness should be part of their curriculum and instruction. In this way, teaching for global readiness is integrated with the standard course of study in all grades and courses and comprises two subthemes: overt instruction and whole child approach.

**Overt instruction.** Overt instruction requires intentionality about global learning. Overt does not necessarily mean lecture-style instruction. Rather, participants scaffolded



global learning and were intentional about incorporating discipline-specific global information with the academic goals of the curriculum. One participant integrated global learning into a substantive inquiry project. She partnered with a school in another country, and the students worked in international teams to complete the project. She set academic content goals for the project but she also set global learning goals, such as that the students would learn how the culture in the other country is different from U.S. culture and how the teenage experience is similar in the other country and the U.S. She scaffolded by having conversations with the students about approaching sensitive subjects in conversations and by formative assessment throughout the inquiry project. She checked in with students after they formulated their inquiry question, after they found their resources, etc. She explained, “I don't think the students got a ‘grade’ for global learning, but their question had to be of social significance to both countries and their sources had to be from both countries.” In this way, global learning was intentional, students’ process was scaffolded, and growth assessed, though informally.

Overt instruction is explicitly discipline-specific. To exemplify discipline-specific global learning, a math educator participant stated,

Every teacher can kind of think about a practice that is content-specific to them, you know, with what they’re teaching. And it’s like, ‘Oh, so with this lens I would have to think about such and such.’ And again, so for mathematics, you know, history of mathematics is so rich in cultural opportunities. And, you know, we think math was invented by, you know, white Europeans. And so it’s really good, I mean, to bring in some of the history as well.

In addition to discipline-specific knowledge, participants stated that students need overt instruction in cross-cultural communication and stereotype reduction in order to be ready for global citizenship and international jobs. As a participant articulated:

There are so many different cultures here in the U.S. that they could encounter. And I think, just working with people, working with their cultures here, and I think that many, many industries work with different cultures. My husband's job works with 20 different countries. And he has to be familiar with the customs of those countries when he goes to visit those countries.

While the jobs of today require people to work with others internationally, participants also stated that their students needed to learn about multiple cultures because their own communities and some of their classrooms are presently home to people from all over the world. One teacher scaffolded global learning by beginning in her own classroom. She reported asking her students: "How can we teach each other about our cultures, first?" By presenting students the global connections already present in their own daily lives, teachers scaffolded instruction by beginning close to home and then scaling out.

**Whole-child Approach.** The term *whole-child* came up numerous times in the interviews. Teachers were very adamant that their job was to teach more than academics.

During the initial stages, talked a lot about our academic goals, which would be to help students become more creative by using the project-based inquiry approach. And we wanted to improve reading and writing skills, and of course, researching skills.

But my international teaching partner said, 'Really, I want my kids to know how to be

better people. And understand concepts that they're not familiar with. Like what it's like to be poor.'

Interestingly, participants from U.S. public institutions stated that teaching for global readiness requires promoting academic, social, emotional, and physical development of students. Participants from other countries and from U.S. private institutions added spiritual development to that list.

### **Critical Frame**

The third theme is critical framing. Participants perceived teaching for global readiness as enacted through a critical frame. The critical frame encourages questioning of oneself and society. A participant explained that questioning is important "to break down stereotypes; we all hold them." As participants shared examples of instructional practices that lead to global readiness, they illustrated how they promoted multiple perspectives and perceived of other cultures through an asset paradigm as opposed to a deficit paradigm. Participants discussed how teaching for global readiness through a critical frame helped students to situate their own interactions historically and culturally and provided students the support needed in order to "change the world." The critical component of teaching for global readiness is dual focused: advancing critical literacy and reflexivity.

**Critical literacy.** Participants favored teaching that encourages students to question and analyze *themselves* and *texts*, and some participants added *society*. Critical literacy instruction involves teaching students to analyze texts for reliability and authorial bias. One participant described her instruction to students by stating that it involves "[having students] thinking about who wrote it [text], where it came from, giving students access to multiple

perspectives that can help create a better awareness.” She went on to say, “I would be doing them a disservice if I wasn’t providing multiple perspectives for them to read about.” As the previous quote illustrates, participants repeatedly stated that providing content from multiple perspectives was an important part of teaching for global readiness. Included in advancing critical literacy, participants reported teaching students to communicate productively as well as to think critically.

Participants were split in their intention for the critical component of teaching for global readiness. Half of the participants stated that teaching for global readiness is to teach students to think for themselves. The other half acknowledged that teaching for global readiness contains an agenda that promotes acceptance of different religions and ways of thinking. Participants agreed that education should push students to “broaden their horizons,” as participants often mentioned. Many participants used primary sources and texts written by authors from diverse countries in order to help students broaden their understandings. One participant explained that he personally puts himself in situations where he is the minority in order to develop new perspectives. Another participant stated, “Part of what education needs to do is push kids out of their comfort zone and help them see the world through a lens that will allow them to adapt to the world and help them also shape the world.” In addition, critical literacy, according to some participants, involved asking students to question society’s biases in order to break down systems of oppression worldwide. This type of critical thinking involves reflexivity, which will be described next.

**Reflexivity.** Reflexivity in the classroom provides a space for students to think about the causes and effects of their own actions and society’s actions or lack of action. While

reflection is not the same as reflexivity, participants perceived reflection as an important component of the practice of reflexivity. One participant stated,

As you're navigating that environment, it's not only reflection *on* action, it's a reflection *in* action. So as it's unfolding, you know, having that ability to reflect and those understandings of other cultures to be able to communicate and articulate those understandings.

A middle grades teacher described an activity she does every year with the purpose of having students question the structures of societies:

I do an activity called *shipwrecked* where they are shipwrecked on an island, and this is the very first activity I do of the year. And they have to essentially build a civilization. And they have to do that collaboratively. . . . But during the course of that lesson, they're talking about leadership, and that leads into types of government. We're talking about laws. Do we need laws? Do we need leaders? Why do we have them? Do we need money? Do we divide up property? And so during the course of those conversations, because they meet in small groups and then we have a class discussion about each thing that they're tackling during the course of activity. And we just talked about, and that led to a discussion about resources. And so that led us into, and that kind of guided it toward the Syrian migrants in Europe right now. And their first response, "Well, I can't believe—why don't they just let them in?" And that led to a discussion about resources.

The participant explained that students draw on this lesson for the rest of the year as they question social structures.

Participants perceived reflexivity as an important part of both instruction for students and teacher practice. Teachers perceived that they needed to reflect on their own assumptions and biases and allow opportunities for students to do the same. Participants stated that outcomes of reflexivity for teachers included more equity in the classroom and for students included “social responsibility” and “moral consciousness.” In this way, some participants believed that promoting global citizenship was essential to teaching for global readiness.

### **Transactional Experience**

Teaching for global readiness must involve a transaction between two cultures, not one-way communication of ideas, but two-way giving and receiving of ideas. A few participants talked about transactions of practice being especially important because of postcolonial viewpoints. These participants wanted students to view other countries, other cultures, and other perspectives as different, interesting, and equal—not as weird, gross, or inferior. One participant described her belief:

I stress that so much because I want them when they are watching the news, or when they meet someone from another country or another culture that they don't automatically, I tell them often, it's not ew, it's not weird, it's different. I mean because they do—their first reaction, we just had that conversation, we're in the third week of school, and something just happened and they went, “Ew.” And I went, “Oh, no, no, no, wait, whoa, wait, wait. It's never ew, it's different, it's different than what I do, but that doesn't make it wrong.” And I think that does build that compassion to be able to see something from another person's point of view.

Transactions of practice were perceived as crucial to democratic education. As one participant asserted:

It's only through that cultural sharing, it's only through those interactions, it's only through those efforts, as Kwame Appiah puts it, it's only through the kindness of strangers, the efforts to do things for people that you don't know, but weren't able to come to the kind of understandings that enable cultural coalitions, that enable kind of the democratic flowering.

*Democratic flowering* was perceived as the growth of democratic values, a positive outcome.

Participants reported that for students to truly become global ready, they needed experiential learning. Teachers used simulations, field trips, guest speakers, cross-cultural collaborations, and project-based learning to give their students new experiences from which to make meaning. To facilitate transactions of practice, participants stated that teachers should provide opportunities for intercultural dialogue as well as transformational experiences where students construct knowledge and grow through the learning process.

**Intercultural dialogue.** Participants spoke of dialogue where students both gave and received communication. They preferred these experiences to one-way experiences where participants perceived that students could develop superiority complexes. One participant illustrated the importance of “Engag[ing] students in those *complicated* conversations either virtually like the pen pal things or synchronously with students from other countries.” The participant continued the thought with how much easier technology makes these complicated conversations. “And certainly with the internet that’s a lot easier.” All participants noted that digital literacy is tied to global learning. One participant stated, “Global learning is

deeply impacted by technology literacy.” In addition to digital literacy, participants perceived that student engagement increased with traditional literacy practices (i.e., reading, writing, speaking, and listening skills) as students conducted discussions and projects with students in other countries. One participant asserted, “I know for a fact that those students were a lot more vested in learning. They had much more analysis in their writing. And they had very rich and just incredible multimedia videos that they produced.”

Participants reiterated their perceptions of the importance of students connecting with real people, whether that involved Skype conversations between classes of second graders, asking questions of guest speakers during field trips, or project management discussions over WeChat between small groups of high schoolers. Participants acknowledged bringing in speakers from different backgrounds and taking students to places within their own community where people from different backgrounds worship or live so that students can not only observe and listen to different perspectives, but ask questions. Participants described taking special education students to ethnic restaurants and taking social studies students to a mosque. One participant explained that this is important because students “were able to get a first-hand perspective.” The first-hand experience was perceived as superior for global readiness development than traditional delivery methods.

Going a step further, participants desired that their students develop relationships with people from different countries. One participant described the importance of small group conversations during an international collaboration: “It’s like once that trust was built between both sides of the kids, and they realized they could make themselves vulnerable to one another, that’s when things really started happening for the kids.” Participants stated



how the relationships students made during collaboration were the most important part of the project because students learned about another culture in an authentic way while building upon each other's different sets of prior experiences and knowledge. At the same time, the students learned how many similarities they shared with their partners and created connections that increased engagement with the learning. She stated, "They wanted to help each other succeed." Participants also stated that they persisted through the challenges of intercultural dialogue across the globe because of the relationships they developed with their global partner teachers.

**Transformed practice.** Participants stated that teaching for global readiness involved students being transformed through the learning about others and learning from others. Participants specifically perceived two student outcomes: (a) advancing leadership, such as creativity and communication skills, as well as (b) citizenship, or compassion. Students as young as first grade were perceived as increasing their leadership abilities through teaching for global readiness. One participant described,

I really think it's good for the kids to see different perspectives and learn from each other and being able—like, I had a high Hispanic population. They were able to step into that leadership role and communicate to the students in Guatemala, where the students that weren't Spanish speaking did not have that connection. So it kind of also just gives those students with that connection a leadership role that they can step into and take charge.

As part of leadership, participants discussed advancing students' creativity through problem solving and inquiring through multiple perspectives. Several participants mentioned that

problem solving and inquiry on a global level encouraged global citizenship. One participant defined global citizenship:

Global citizenship not only means that you should be able to effectively communicate and collaborate with people from different cultures, different backgrounds, but also you should actually cross the cultural boundary to face some global issues and tackle them effectively. So I will see the world not as a world of factories; it's like you are working with people and you feel comfortable working with them, but I would also see it as a global village, and that is the final goal of how to cultivate—of promoting global citizenship.

In addition to global citizenship, several participants perceived that teaching for global readiness increased students' ambitions. For example, a participant said that “to be able to envision a life outside of the current cycle of poverty that they're in because of this partnership, to visualize themselves going to school in another place, or working with people in another country, was way more than I could have ever envisioned.” Transformed practice involved more than changes in what the students knew but also changes in how the students believed and acted. One participant shared that her students told her that the international collaboration project they completed “really changed them.” She shared that students seemed more socially aware and responsible and confident that they could make a difference in the world.

### **Summary**

All in all, teaching for global readiness was perceived by the 24 global educators as necessary for their students. They enacted teaching for global readiness through four themes:

situated practice, integrated global learning, critical framing, and transactional experience. In the second phase of the project design, these qualitative findings were used to develop an instrument to measure practices related to teaching for global readiness.

## CHAPTER 5 – Quantitative Results

In order to define, quantify, and validate teaching for global readiness, I conducted a two-phase study. My goal for the first phase of the study was to qualitatively identify the key practices that teachers engage in during instruction for global readiness. I then generated survey items based on the qualitative data. Next, I quantitatively tested the relationship among those practices through a self-report survey of 40 items distributed to K-12 teachers in the U.S. The goal for the second phase was to ascertain the underlying factor structure of teaching for global readiness. The results of the survey specifically answered two research questions: (a) What are the factors of the teaching for global readiness construct? and (b) To what extent are the themes about TGR from the qualitative findings generalizable to a sample of a population of K-12 teachers? This section will present the results of preliminary data analysis (including EFA results) and then report the CFA results.

### **Preliminary Data Analysis**

The web survey was administered to 3,354 K-12 teachers who were part of a global education professional development database and included the 40-item potential items of the teaching for global readiness scale, nine-item global competency subscale from the global citizenship scale (Morais & Ogden, 2011), and demographic items. The resulting 630 participants who completed the survey were randomly split into two groups using the random function in Microsoft Excel ( $n = 341$  and  $n = 289$ ). While both sample sizes would be suitable for exploratory factor analysis, I expected increased confidence over the course of the analysis so I chose the larger of the two samples to begin the process because a larger sample size increases statistical power and reliability (Hutcheson & Sofroniou, 1999). Thus,

the larger sample of 341 was used for the exploratory factor analysis and 289 for the confirmatory factor analysis. All analyses and data transformations were performed with Stata IC-13 software.

The first step in factor analysis is to assess the appropriateness of variables based upon variance and correlations (Hutcheson & Sofroniou, 1999). This was partially achieved by computing means and standard deviations. A visual analysis of the ranges of means and standard deviations for each item indicated variation in responses. Appendix I displays summary statistics for both samples. The Kaiser–Meyer–Olkin (KMO) measure and polychoric correlations were calculated in order to judge items that may have excessively high and low correlations. The first sample of observations ( $n = 341$ ) was assessed using KMO to test sampling adequacy of items. KMO takes into account correlations in order to assess multicollinearity and determine suitability of individual items (Field & Zoe, 2012). The KMO values indicated that the sample adequacy was “meritorious” ( $KMO = .89$ ; Hutcheson & Sofroniou, 1999, p. 225). The KMO value for each item was considered at least at the “middling” level ( $KMO > .76$ ; Hutcheson & Sofroniou, 1999, p. 225). Next, polychoric correlations were conducted to evaluate item-item correlations of ordinal data. This step allowed the researcher to assess items that may not correlate to the underlying structure under investigation. One item (*critical thinking*) displayed a correlation of less than .40 with any other item and was therefore removed to lessen the likelihood of error and increase reliability within EFA (Hinkin, 1998; Hutcheson & Sofroniou, 1999; Kim and Mueller, 1978). Polychoric correlation results can be found in Appendix J.

## Exploratory Factor Analysis

To determine the most adequate number of factors to extract, a scree plot (Cattell, 1996), eigenvalues, and the interpretability of the rotated solution were assessed (see Figure 5.1; Kim & Mueller, 1978). Based on a visual analysis of the scree plot, four points appeared above the elbow. Five factors had eigenvalues clearly above the Kaiser criterion of  $>1$  (Kim & Mueller, 1978). Both four and five factor solutions were explored. The four-factor solution was clearer and fit the conceptual model better and was thus used in the EFA.

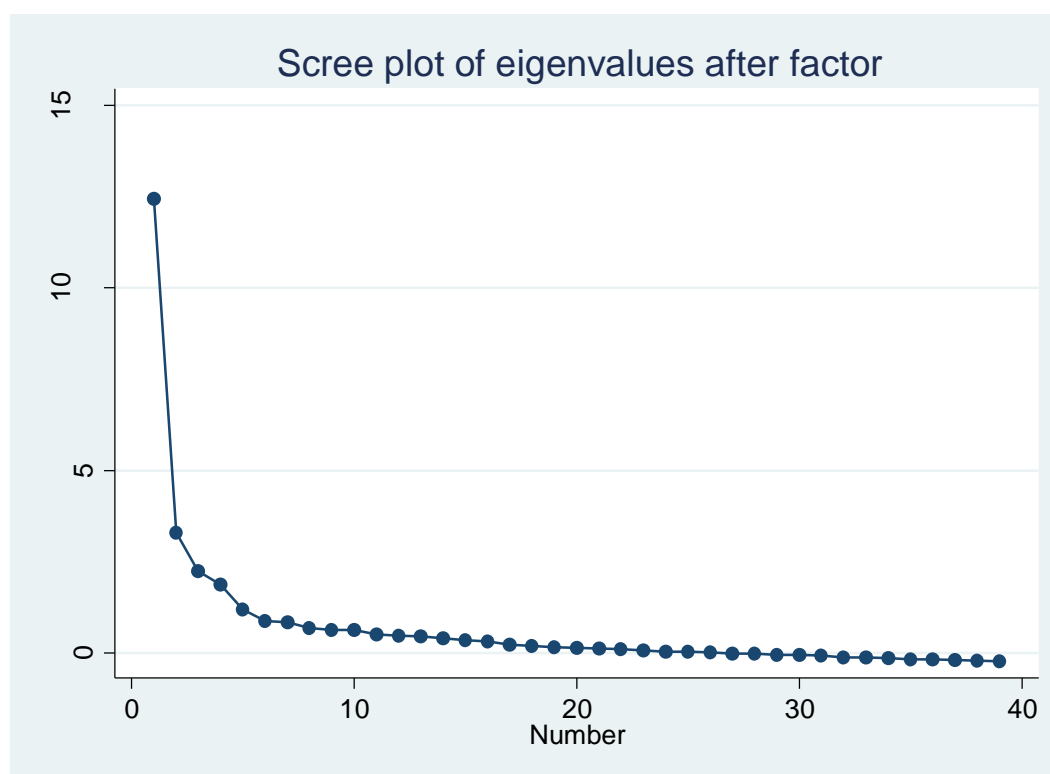

Figure 5.1. Scree plot of eigenvalues.

A principal axis factor analysis was performed on polychoric correlations with orthogonal varimax rotation. Orthogonal rotation provided a clearer factor structure than oblique, suggesting that the factors were only moderately correlated (Gaskin & Happell, 2014).

### **Retaining Items**

For item elimination, the commonly used criterion of loadings above 0.40 (Ford, MacCallum, & Tate, 1986) was utilized and all items with loadings above 0.40 were considered at this point in the analysis, resulting in a 30-item teaching for global readiness scale. The retained items, as shown in Table 5.1, indicated good factor structure with minimal cross loadings on secondary factors. The factor loadings show the unique relationships between each latent variable (or factor) and measured variable (or item). The four-factor solution explained 74% of the variance. Typically, over 60% is considered acceptable (Hinkin, 1998; Comrey & Lee, 1992). The four factors were straightforward to interpret and “theoretically meaningful” (Hutcheson & Sofroniou, 1999, p. 244). The interpretation follows.

Factor one consisted of eight items with factor loadings ranging from 0.45 to 0.80. Strong loadings were found for the following items: *I ask students to analyze the reliability of a source*, *I ask students to engage in discussions about international current events*, and *I ask students to analyze content from multiple perspectives*. A few items loaded on factors unexpectedly. For example, *I ask students to read/view international sources*, *I keep informed on global issues*, and *I am informed through international sources* were identified by experts during the content validity trial as integrated (factor three) but loaded higher on critical (factor one). Items representing the categorical code of reflexivity, for example *I*

*reflect on my own bias and assumptions*, did not load. For these reasons, the name of factor one was revised from *critical framing*, as intended from the qualitative findings, to *critical literacy*. The items identified as integrated but loading on critical all involve multiple sources, an important part of critical literacy conceptually.

Factor two consisted of seven items with loadings ranging from 0.44 to 0.84. Items with strong loadings on this factor included *I cultivate a classroom environment that values diversity*, *I cultivate a classroom environment that promotes equality*, and *I provide a space that allows students a voice*. Factor two relates to teacher practices that establish a community of learners, so the factor was named *situated practice*. The item *I guide students to examine other possible perspectives* conceptually aligns to factor one but it also aligns to establishing a community so the item was retained at this point in the analysis.

Factor three consisted of nine items with loadings ranging from 0.41 to 0.56. The item with the strongest loading on this factor was *I integrated global learning with the existing curriculum*. These items relate to teachers' intentions to provide instruction on global learning within the typical classroom structure so the factor was named *integrated global learning*. One item, *I teach cross-cultural communication skills*, was identified by experts during the content validity trial as *transactional* (factor one) but loaded higher on *integrated* (factor three). In addition, *I use class materials based on real world issues* and *I adapt my teaching methods to meet the needs of a culturally diverse student group* were identified by experts as *situated* (factor two) but loaded higher on *integrated*. *I use inquiry-based lessons about the world* was identified as *critical* (factor one) but loaded higher on *integrated*. Teaching cross-cultural skills and using real world materials aligned conceptually with



intentional instruction. Adapting teaching and inquiry-based lessons aligned with the integration of social and cultural growth with academic growth, so all were retained.

Factor four consisted of six items with factor loadings that ranged from 0.44 to 0.87, including *I ask students to utilize asynchronous technology (e.g., email, blogs) for international collaboration, I ask students to utilize synchronous technology (e.g., Skype, GoogleHangout) for international collaborations, and I ask students to utilize technology (e.g., Skype, email) for virtual interviews (with experts, community members, etc.)*. These items related to teachers creating experiences for students to interact with people outside of the classroom and so were named *transactional experience*.

Overall, seven items were not retained for the scale. Five items loaded on multiple factors. Two items did not load at acceptable values on any factor (i.e., *C.2. I reflect on my own bias and assumptions* and *T.6. I ask students to share their culture with other students*). Two items (i.e., *I.7. I ask students to conduct standards-aligned investigations of the world* and *I.10. I display artifacts (e.g., maps, posters, souvenirs) from other countries in my classroom*) loaded but did not conceptually align with the other items in that factor (i.e., *transactional experience* and *situated practice*).

Table 5.1.

*Factor Loadings from Exploratory Analysis*

#	Measured	Factor 1	Factor 2	Factor 3	Factor 4	Retained
C.7.	I ask students to engage in discussions about international current events.	0.79				•
C.5.	I ask students to analyze the reliability of a source.	0.80				•
C.6.	I ask students to analyze content from multiple perspectives.	0.77				•
C.8.	I ask students to construct claims based on primary sources.	0.73				•
I.6.	I ask students to read/view international sources (e.g. BBC, Al Jazeera).	0.61				•
C.11.	I teach my students to analyze the agenda behind media messages.	0.56				•
I.3.	I keep informed on global issues.	0.51				•
I.9.	I am informed through international sources.	0.45				•
S.4.	I cultivate a classroom environment that values diversity.		0.84			•
S.7.	I cultivate a classroom environment that promotes equality.		0.83			•
S.9.	I provide a space that allows students a voice.		0.81			•
C.9.	I guide students to examine other possible perspectives.		0.67			•
S.6.	I provide a space that allows learners to take risks.		0.66			•
S.5.	I take inventory of the cultures (languages, countries, etc.) represented by my students.		0.57			•

Table 5.1. (Continued)

#	Measured	Factor 1	Factor 2	Factor 3	Factor 4	Retained
S.8.	I attempt to break down students' stereotypes.		0.55			•
I.10.	I display artifacts (e.g., maps, posters, souvenirs) from other countries in my classroom.		0.44			
I.2.	I integrated global learning with the existing curriculum.			0.56		•
S.1.	I use class materials based on real world issues.			0.56		•
I.1.	I plan to use texts written by authors from diverse countries			0.57		•
T.3.	I teach cross-cultural communication skills.			0.54		•
I.5.	I assess students' global learning.			0.52		•
I.8.	I build a repertoire of resources related to global education.			0.51		•
S.3.	I adapt my teaching methods to meet the needs of a culturally diverse student group.			0.50		•
I.11.	I facilitate conversation about connections between my students and other countries.			0.50		•
C.1.	I use inquiry-based lessons about the world (e.g., research projects, exploratory learning, discovery learning).			0.41		•
T.8	I ask students to utilize synchronous technology (e.g., Skype, GoogleHangout) for international collaborations.				0.87	•
T.9.	I ask students to utilize asynchronous technology (e.g., email, blogs) for international collaboration.				0.80	•
T.7.	I ask students to utilize technology (e.g., Skype, email) for virtual interviews (with experts, community members, etc.).				0.78	•

Table 5.1. (Continued)

#	Measured	Factor 1	Factor 2	Factor 3	Factor 4	Retained
T.2.	I facilitate conversations between my students and students in other countries.				0.52	•
T.5.	I take students on field trips to international places within the community (e.g., mosque, Asian market, Japanese garden).				0.50	•
T.4.	I bring in speakers from different backgrounds so that students can listen to different perspectives.				0.44	•
I.7.	I ask students to conduct standards-aligned investigations of the world.				0.45	
S.2.	I differentiate instruction to meet the needs of diverse learners.		0.53	0.63		
T.1.	I design international collaboration projects for my students.			0.53	0.40	
I.4.	I integrate intl current events with the curriculum	0.55		0.45		
C.9.	I guide students to examine their cultural identity.		0.51	0.41		
C.4.	I provide students with more than two perspectives on global issues.	0.50		0.52		
T.6.	I ask students to share their culture with other students.					
C.2.	I reflect on my own bias and assumptions					

*Note:* Blanks represent < .40.

### Confirmatory Factor Analysis Results

Confirmatory factor analysis (CFA) begins with a hypothesized measurement model. CFA using maximum likelihood estimation was conducted with the second group of the original 630 cases ( $n = 289$ ) to test the factor structure of the 30 retained items from exploratory results (Fabrigar, et al., 1999). The four-factor model assumes that the

measurement variables were driven by four latent factors: (a) critical literacy, (b) situated practice, (c) integrated global learning, and (d) transactional experience, based on the results from the EFA.

### **Model Fit**

Goodness of fit was evaluated using Hu & Bentler's (1999) criteria for the following statistics: (a) chi-square statistic ( $\chi^2$ ), (b) comparative fit index (CFI), (c) Tucker-Lewis index (TLI), standardized root mean square residual (SRMR), and (f) root mean square error of approximation (RMSEA). The proposed four-factor model originally revealed a marginal fit to the data ( $\chi^2 (203) 711.07, p < .001, CFI = 0.83, TLI = 0.81, SRMR = 0.09, RMSEA = 0.09$ ). Goodness of fit statistics provide a global view of fit, but in order to improve fit, the researcher must look in the solution for specific areas of ill-fit, such as misspecification of error covariance between items and weak indicator-factor relationships. Modification indices, standardized residuals, and factor loadings are statistics that can be used to identify specific areas of ill-fit (Brown & Moore, 2015). Modification indices provide covariance paths left out of the model and the expected parameter change of chi-square. For the purposes of this study, values above 20 were examined as this indicates violated equality constraints (Norwegian Social Science Data Services, 2013). Standardized residuals of 1.96 or higher are considered unsatisfactory (Brown & Moore, 2015). Factor loadings of .55 or higher are considered good and .45 to .54 are considered fair (Comrey & Lee, 1992).

The first step in efforts to improve fit is to look for items that carry the most error. Six items were eliminated due to high standardized residuals, as indicated in bold in Table 5.2 (i.e., I.6., I.3., I.1., T.3., I.11, and T.2.). Next, three items were eliminated due to factor

loadings below .45 (i.e., I.3, I.9, and S.3.). Modification indices were then evaluated.

Specification of correlated measurement error was added to three pairs of measured variables (i.e., C.5. and C.6., S.4. and S.7., S.6. and S.9.) based on statistics and method effects, as the items contained similar wording (Brown & Moore, 2015; Hooper, Coughlan, & Mullen, 2008). CFI was still not above .95, so factor loadings below .55 were examined. Two items were removed (S.1. and T.5). Item T.4. loaded at the fair level (0.53) but was kept because of conceptual importance to the scale and little difference observed in the model fit. One item (C.9.) was removed based on high modification indices and redundancy in the subscale. Appendix I displays the goodness of fit statistics for the different models.

Table 5.2.

*Item-to-Factor Statistics from Confirmatory Factor Analysis*

#	Measurement	Factor loading	Standard error	Residual	$R^2$	MI >20	Removed
I.6.	<b>readintlso~s</b>	<b>0.54</b>	0.05	<b>2.17</b>	0.29		•
C.7.	discussint~s	0.70	0.03	1.74	0.49		
C.5.	reliabilit~e	0.83	0.02	1.21	0.69		
C.6.	analyzemul~v	0.90	0.02	0.75	0.80		
C.8.	primarysou~s	0.84	0.02	1.12	0.71		
C.11.	analyzeage~a	0.61	0.04	0.75	0.37		
I.3.	<b>keepinformed</b>	<b>0.46</b>	0.05	<b>2.29</b>	0.21		•
I.9.	<b>iaminforme~s</b>	<b>0.44</b>	0.05	0.68	0.19	•	•
S.4.	valuesdive~y	0.80	0.03	0.14	0.64		
S.7.	promoteseq~y	0.80	0.03	0.12	0.64		•
S.5.	inventoryo~s	0.72	0.03	0.27	0.51		
C.9.	<b>examineoth~s</b>	0.71	0.03	0.25	0.50	•	•
S.6.	risk	0.69	0.04	0.22	0.47		
S.9.	voice	0.73	0.03	0.16	0.54		
S.8.	breakdowns~s	0.61	0.04	0.30	0.37		
I.2.	integrateg~m	0.72	0.04	1.05	0.51		

Table 5.2. (Continued)

#	Measurement	Factor loading	Standard error	Residual	R <sup>2</sup>	MI >20	Removed
S.1.	<b>realworldm~s</b>	<b>0.50</b>	0.05	1.50	0.25		•
I.1.	<b>authorsdiv~s</b>	0.58	0.04	<b>2.02</b>	0.34		•
T.3.	<b>crosscultu~m</b>	0.60	0.04	<b>2.59</b>	0.36		•
I.5.	assessgl	0.70	0.04	1.48	0.49		
I.8.	repertoire~s	0.66	0.04	0.50	0.43		
S.3.	<b>adaptteach~g</b>	<b>0.28</b>	0.06	0.81	0.08		•
I.11.	<b>convosconn~s</b>	<b>0.51</b>	0.05	<b>2.78</b>	0.26		•
C.1.	pbi	0.65	0.04	1.69	0.42		
T.8.	synchtech	0.85	0.03	0.46	0.72		
T.9.	asynchtech	0.71	0.04	0.82	0.51		
T.2.	<b>convosstud~s</b>	<b>0.42</b>	0.05	<b>2.76</b>	0.18		•
T.4.	bringspeak~s	<b>0.53</b>	0.05	0.64	0.28		
T.5.	<b>intfieldt~s</b>	<b>0.49</b>	0.05	0.30	0.24		•
T.7.	virtualint~s	0.76	0.03	1.30	0.58		

Removing these items did not compromise the integrity of the scale conceptually and improved the model fit (Hooper, Coughlan, & Mullen, 2008). Overall, the revised model fit well with excellent CFI, TLI, RMSEA, and SRMR values ( $\chi^2$  (143) 246.91,  $\chi^2/df = 1.73$ , CFI = 0.96, TLI = 0.95, SRMR = 0.06, RMSEA = 0.05). Table 5.3 displays all goodness of fit statistics calculated. A  $\chi^2$  difference test was conducted and  $\Delta \chi^2$  significant at  $p < 0.001$ . The retained measurement model is presented in Figure 5.2. The analysis resulted in 19 measured variables on four latent variables. The measurement model consisted of five measured variables for latent variable *critical*, six measured variables for latent variable *situated*, four measured variables for latent variable *transactional*, and four measured variables for latent variable *integrated*. The scale consisted of four to six items per factor, balancing statistical strength with parsimony (Costello & Osborne, 2005).

Table 5.3.

*Goodness of Fit Statistics for Measurement Model*

Fit statistic	Value
Likelihood ratio	
chi <sup>2</sup> _ms	(143) 246.91
<i>p</i> > chi <sup>2</sup>	0.000
chi <sup>2</sup> _bs	(171) 2787.28
<i>p</i> > chi <sup>2</sup>	0.000
Population error	
Root mean squared error of approximation	0.05
90% CI, lower bound	0.04
upper bound	0.06
<i>p</i> close	0.43
Information criteria	
Akaike's information criterion	14066.47
Bayesian information criterion	14306.36
Baseline comparison	
Comparative fit index	0.96
Tucker-Lewis index	0.95
Size of residuals	
Standardized root mean squared residual	0.06
Coefficient of determination	0.99

**Convergent Validity**

The TGRS and GSC were administered simultaneously. Correlation was computed for participants' score on the TGRS and GSC global competence subscale ( $r = 0.55$ ), indicating a positive moderate relationship. Regressing GCS on TGRS resulted in a positive relationship ( $\beta = 0.62$ ,  $F(1, 327) = 138.60$ ,  $p < 0.001$ ,  $r^2 = 0.30$ ). Possessing global competency is associated with on average a 0.62 point increase on the teaching for global readiness scale. This relationship indicates construct validity of teaching for global readiness (Hinkin, 1992).



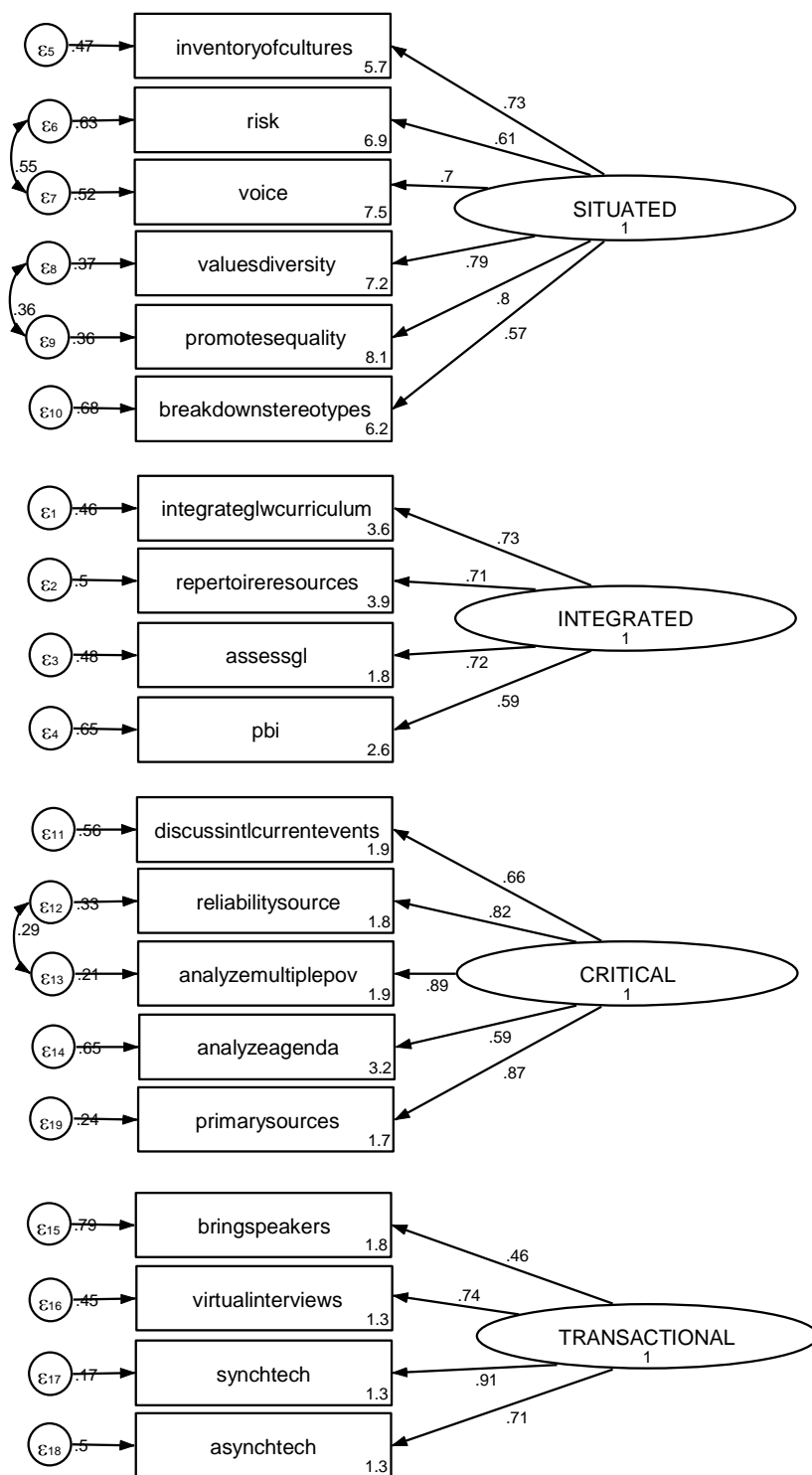

Figure 5.2. Standardized factor loading for the four-factor CFA.

## Internal Consistency

Internal consistency and reliability analysis was then conducted on the four factors.

Item reliability coefficients can be seen in Table 5.4.

Table 5.4.

### *Reliability Statistics for Measurement Model*

Item	Obs.	Item-test Correlation	Item-rest Correlation	Ave. Interitem Covariance	Alpha
C.5. reliabilitysource	288	0.73	0.65	0.46	0.87
C.6. analyzemultiplepov	288	0.79	0.73	0.45	0.86
C.7. discussintlcurrentevents	287	0.71	0.65	0.47	0.87
C.8. primarysources	288	0.76	0.69	0.46	0.87
C.11. analyzeagenda	289	0.57	0.51	0.52	0.87
S.4. valuesdiversity	289	0.43	0.40	0.55	0.89
S.5. inventoryofcultures	289	0.45	0.40	0.55	0.88
S.6. risk	289	0.40	0.36	0.55	0.88
S.7. promotesequity	288	0.35	0.31	0.56	0.88
S.8. breakdownstereotypes	289	0.50	0.45	0.54	0.88
S.9. voice	288	0.39	0.35	0.55	0.88
I.2. integrateglwcurriculum	288	0.54	0.50	0.51	0.87
I.5. assessgl	285	0.67	0.59	0.49	0.87
I.12. repertoireresources	289	0.60	0.56	0.52	0.87
C.1. pbi	287	0.61	0.53	0.50	0.87
T.4. bringspeakers	285	0.48	0.43	0.54	0.88
T.7. virtualinterviews	287	0.57	0.48	0.50	0.88
T.8. synchtech	287	0.56	0.49	0.52	0.87
T.9. asynchtech	287	0.53	0.46	0.52	0.88
Test scale				0.52	0.88

Reliability was estimated using Cronbach's  $\alpha$  and the results were considered acceptable:

- factor 1 (CRITICAL -> C.5., C.6., C.7., C.8., and C.11.) coefficient at 0.88
- factor 2 (SITUATED -> S.4., S.5., S.6., S.7., S.8., and S.9.) coefficient at 0.85

- factor 3 (INTEGRATED -> I.2., I.5., I.12., and C.2.) coefficient at 0.75
- factor 4 (TRANSACTIONAL -> T.4., T.7., T.8., and T.9.) coefficient at 0.79

While several items seemed to have low correlation coefficients relative to the other items, it did not seem to affect the overall reliability of 0.88. Generally, 0.7 is considered as an appropriate level of reliability for scales (Comrey & Lee, 1992; Nunnally, 1978).

Table 5.5.

## Teaching for Global Readiness Scale Statistics

Item	Factor Loading	Item-test Correlation	Subscale Reliability
<b>Critical</b>			0.88
C.5. I ask students to analyze the reliability of a source.	0.83	0.73	
C.6. I ask students to analyze content from multiple perspectives.	0.90	0.79	
C.7. I ask students to engage in discussions about international current events.	0.70	0.71	
C.8. I ask students to construct claims based on primary sources.	0.84	0.76	
C.11. I ask students to analyze the agenda behind media messages.	0.90	0.57	
<b>Situated</b>			0.85
S.4. I cultivate a classroom environment that values diversity.	0.80	0.43	
S.5. I take inventory of the cultures (languages, countries, etc.) represented by my students.	0.72	0.45	
S.6. I provide a space that allows learners to take risks.	0.69	0.40	
S.7. I cultivate a classroom environment that promotes equality.	0.80	0.35	
S.8. I attempt to break down students' stereotypes.	0.61	0.50	
S.9. I provide a space that allows students a voice.	0.73	0.39	

Table 5.5 (Continued)

Item	Factor Loading	Item-test Correlation	Subscale Reliability
<b>Integrated</b>			0.75
I.2. I integrate global learning with the existing curriculum.	0.72	0.54	
I.5. I assess students' global learning.	0.70	0.67	
I.12. I build a repertoire of resources related to global education.	0.66	0.60	
C.1. I use inquiry-based lessons about the world (e.g., research projects, exploratory learning, discovery learning).	0.65	0.61	
<b>Transactional</b>			0.77
T.4. I bring in speakers from different backgrounds so that students can listen to different perspectives.	0.53	0.48	
T.7. I ask students to utilize technology for virtual interviews (with experts, community members, etc.).	0.76	0.57	
T.8. I ask students to utilize synchronous technology (e.g., Skype, GoogleHangout) for international collaborations.	0.85	0.56	
T.9. I ask students to utilize asynchronous technology (e.g., email, blogs) for international collaborations.	0.71	0.53	

Note.  $\chi^2$  (143) 246.91,  $\chi^2/df = 1.73$ , CFI = 0.96, TLI = 0.95, SRMR = 0.06, RMSEA = 0.05,  $\alpha = 0.88$

### Summary of Results

The results presented in this chapter examined the factors of the construct teaching for global readiness. The primary interest of this study was to operationalize and validate the construct of teaching for global readiness as a scale of teacher practices. In the quantitative phase, teaching for global readiness data were collected from 630 K-12 teachers and then randomly split into two groups. Through exploratory methods on the split-half data, four distinct factors were interpreted: critical literacy, situated practice, integrated global learning,

and transactional experience. To test the factor structure, the second group of the randomly split data was analyzed with maximum likelihood CFA. The study resulted in 19 items on four factors (CRITICAL -> C.5., C.6., C.7., and C.8.); (SITUATED -> S.4., S.5., S.6., S.7., S.8., and S.9.); (INTEGRATED -> I.2., I.5., I.12., and C.1.); (TRANSACTIONAL -> T.4., T.7., T.8., and T.9.). Cronbach's alpha and goodness of fit criteria demonstrated desirable validity and reliability. This is the first study of its kind to operationalize, measure, and validate the construct of teaching for global readiness. The result is an empirical model and a self-report instrument to measure teachers' practices related to the construct teaching for global readiness.

## CHAPTER 6 – Discussion and Conclusions

This study used a sequential exploratory mixed method design as a vehicle for answering the overarching research question: How can we operationalize teaching for global readiness? Together the qualitative and quantitative results provided insight into this question. Specifically, qualitative data provided the basis for the scale items that were subsequently piloted and then tested in the quantitative segment of the study. Exploratory factor analysis indicated a four-factor structure. Confirmatory factor analysis replicated the factor structure suggesting stability of the instrument. The four-factor solution was interpreted as the first factor representing *critical literacy*, the second as *situated practice*, the third as *integrated global learning*, and the fourth as *transactional experience*. The purpose of the study was two-fold. The primary purpose was to validate the construct of teaching for global readiness. The secondary purpose was to develop a scale that collected an array of data on teaching practices that promote students' global readiness. In Chapters Four and Five, I presented the detailed empirical evidence from both phases of the study. In this chapter, I have two goals: (a) synthesize the qualitative and quantitative findings and relate the findings to the extant research, and (b) consider the implications of this study for policy, practice, and future research.

### **Synthesis of Findings**

This exploratory sequential mixed methods study resulted in a qualitatively-grounded construct and quantitative scale to measure teaching for global readiness. The validated scale contains 19 measured variables on four factors: *critical literacy*, *situated practice*, *integrated global learning*, and *transactional experience*. Critical literacy and situated practice directly

align with pedagogy of multiliteracies theory (New London Group, 1996) and transactional experiences directly align with educational cosmopolitanism (Wahlström, 2014). Integrated global learning, while not a word used by the New London Group, signifies two separate ideas from the theory: a) social and cultural learning integrated with academic learning and b) the overt instructional approach. The multidimensional construct is illustrated in figure 6.1.

The first factor is *critical literacy*. Critical literacy, borrowing from Paulo Freire, asks students to read and write the world and the word (McLaughlin & DeVogd, 2004). Educators who promote critical literacy teach students to think critically and to inquire using critical literacy (Kalantzis & Cope, 2001; Hull, Stornaiuolo, & Sahni, 2010; Morrell, 2002). Teachers provide texts about past and current international events from multiple perspectives. Students develop the capacity to question the authority of the source of information, analyze the authors' purposes, and locate primary sources. Students develop the tools to question, protest, negotiate, connect, and advocate in the service of tearing down systems of inequality and designing new futures (New London Group, 1996). This factor consists of five items:

- I ask students to engage in discussions about international current events.
- I ask students to analyze the reliability of a source.
- I ask students to analyze content from multiple perspectives.
- I ask students to analyze the agenda behind media messages.
- I ask students to construct claims based on primary sources.

The second factor is *situated practice*. Situated practice, as introduced by the New London Group (1996), is concerned with the context of the people, place, and time of

learning. Situated practice means that learning is contextual and teaching should be relevant, authentic, and social. This pedagogy makes learning relevant by considering the community, both in the classroom and the larger society within which the learning is taking place.

Teachers accomplish this by building relationships with students and their families. The teacher cultivates a community by promoting equality, ensuring that students have a voice, feel safe to take risks, and part from stereotypical notions of others (Kim & Slapac, 2015; Mills, 2006). In situated practice, teachers are aware of and value students' diverse cultural experiences (Parkhouse et al., 2015). Situated practice is a democratic pedagogy and a sociocultural pedagogy that is relevant to and responsive to the students as social and cultural beings. Factor two consists of six items:

- I take inventory of the cultures (languages, countries, etc.) represented by my students.
- I cultivate a classroom environment that values diversity.
- I cultivate a classroom environment that promotes equality.
- I provide a space that allows learners to take risks.
- I provide a space that allows students a voice.
- I attempt to break down students' stereotypes.

The third factor is *integrated global learning*. Integrated global learning provides overt instruction (New London Group, 1996) on global issues and concepts. Rather than thinking of global education as an add-on or a replacement, teachers demonstrate how the local is already global (Asia Society, 2015; Appiah, 2006; North Carolina State Board of Education, 2013). To support integrated global learning, teachers gather a variety of global



readiness materials and resources that relate to their students and course of study. Teachers incorporate global learning with existing structures to teach global readiness skills and dispositions, such as inquiry-based learning grounded in the curriculum and applied to the world. Integrated global learning factor corroborates the Globally Competent Teaching Continuum criteria “integrate learning experiences for students that promote content-aligned explorations of the world” (Parkhouse et al., 2015, p. 28). Teachers across grade levels and across the curriculum intentionally and systematically assess global learning. Factor three consists of four items:

- I integrate global learning with the existing curriculum.
- I build a repertoire of resources related to global education.
- I use inquiry-based lessons about the world (e.g., research projects, exploratory learning, discovery learning).
- I assess students’ global learning.

Transactional experience involves transactions of practice through hospitable experiences—face-to-face or virtually—with diverse others (Wahlström, 2014). As students engage in intercultural dialogue, they can learn from sharing each others’ perspectives (Hull, Stornaiuolo, & Sahni, 2010; Parkhouse et al., 2015). Firsthand experiences are essential for student development of intercultural competency (Bosney et al., 2015; Cushner & Karim, 2004). In these firsthand learning experiences, students interact with others in an exchange of information and ideas in a way that requires receptive language (e.g., listening and reading) as well as expressive language (e.g., speaking and writing) so that there is give and take from both parties. Teachers build partnerships in the community and globally for

collaborations. Teachers utilize technology to connect their students with people from all over the world and to facilitate international collaborations that encourage active listening and perspective taking (Parkhouse et al., 2015). The fourth factor, *transactional experience*, consists of four items.

- I bring in speakers from different backgrounds so that students can listen to different perspectives.
- I ask students to utilize synchronous technology (e.g., Skype, GoogleHangout) for international collaborations.
- I ask students to utilize asynchronous technology (e.g., email, blogs) for international collaborations.
- I ask students to utilize technology for virtual interviews (with experts, community members, etc.).

*Figure 6.1.* Teaching for Global Readiness Model.

# Teaching for Global Readiness

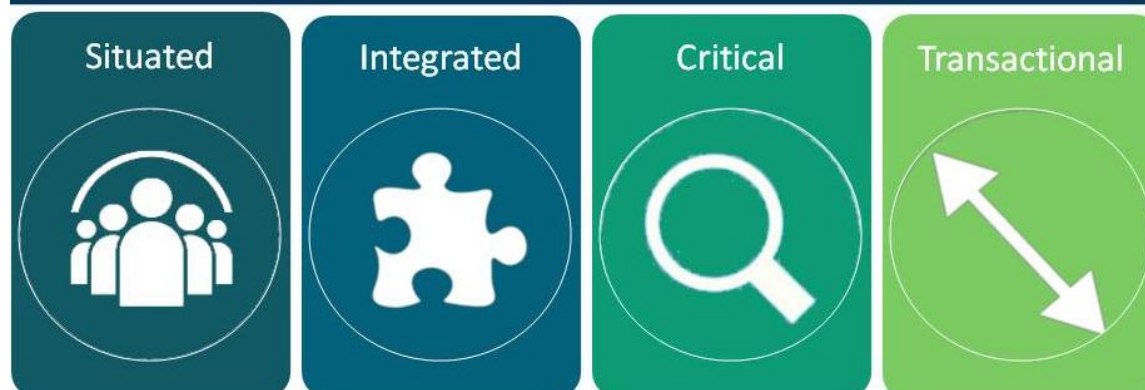

## SITUATED PRACTICE

- I take inventory of the cultures represented by my students.
- I cultivate a classroom environment that values diversity.
- I cultivate a classroom environment that promotes equality.
- I provide a space that allows learners to take risks.
- I provide a space that allows students a voice.
- I attempt to break down students' stereotypes.



## INTEGRATED GLOBAL LEARNING

- I integrate global learning with the curriculum.
- I build a repertoire of resources related to global education.
- I use inquiry-based learning.
- I assess students' global learning.



## CRITICAL LITERACY

- I ask students to engage in discussions about international current events.
- I ask students to analyze the reliability of a source.
- I ask students to analyze content from multiple perspectives.
- I ask students to analyze the agenda behind media messages.
- I ask students to construct claims based on primary sources.



## TRANSACTIONAL EXPERIENCES

- I bring in speakers from different backgrounds so that students can listen to different perspectives.
- I ask students to utilize synchronous technology for intl. collaboration.
- I ask students to utilize asynchronous technology for intl. collaboration.
- I ask students to utilize technology for virtual interviews.

### **Implications for Research, Policy, and Practice**

In this section, I will consider the limitations and the implications of this study for future research, education policy, and classroom practice. Overall, the results of this study suggest practices teachers can adopt to promote students' global readiness. In order for research to be valid, the instruments employed must be valid (American Psychological Association, 2014). This study offers a validated scale for future research.

**Limitations and Implications for Research.** Internal and external validity are always a concern in scale development. Specific threats to internal and external validity of this study lead to limitations when interpreting the results. One threat to internal validity is the fact that TGRS is a self-report survey. Self-report assumes that respondents are willing to answer truthfully and able to answer accurately (Groves et al., 2009). Truthful responses are more likely if the scale is not being used for teacher evaluation. Another possible concern is that the sample was not a random sample of U.S. K-12 teachers. The sample frame was chosen because it decreased the scope of the study making it logistically possible and because variance around factors is the most important criterion needed for exploratory analysis. Nevertheless, a limitation of the study is that the results cannot be used to generalize the current status of practices to K-12 teachers in the U.S. Future research using random samples are needed to continue to refine the scale by showing continued generalizability of the four factors and to allow for generalizability of the frequency of current practices. Another possible concern is the 19% response rate, which may introduce error into the data. Particularly concerning is low response rates within certain groups. Comparison of key variables by early and late respondents can enhance external validity

when issues of low response rate arise (Radhakrishna & Doamekpor, 2008). Based on survey method research, late respondents tend to answer similarly to non-respondents (Miller & Smith, 1983). To address the concern of low response rate, a histogram of response dates was generated. Visual analysis of the histogram showed one tall peak in December and two shorter peaks in January. The sample was then divided into two groups: (a) December dates to represent early respondents, and (b) January dates to represent late respondents. T-tests were performed on the strongest variable (i.e., promote equality, analyze multiple points of view, integrate global learning, and utilize synch tech) in each factor by response groups. The differences of means between early and late responders were not different from zero, suggesting no significant differences in variances across groups. Appendix H provides the statistics. Future research needs to be conducted with larger response rates before group-to-group comparisons can be tested; of particular interest is comparison between grade levels and subject areas.

In addition, a challenge of this study was testing for convergent validity. At the time of the study, there was a dearth of research providing valid and reliable instruments on teaching practices related to global education. There were no observational measures for participants' principals or peers to complete for concurrent validity testing of the self-report scale. Future research could create observation protocols to measure teaching for global readiness practices. In addition to observation protocols, this study could be used to create tools for practitioners. Researchers also can utilize the scale to help describe and evaluate professional development and classroom practices for global readiness.

While EFA and CFA are robust statistical analyses, they hold certain limitations. At present, no statistical test exists to establish the significance of rotated factor loadings. In addition, no fixed way exists to determine underlying factors (Comrey & Lee, 1992). While CFA methods do include the chi-square test of statistical significance, researchers frequently use additional fit indices because of the sensitivity of chi-square to model and sample size (e.g., CFI, TLI, and RMSEA). Unfortunately, researchers often report different fit indices and different *a priori* criteria for these indices. The lack of an absolute solution leads to potential discrepancies among EFA and CFA results. This limitation was addressed by following rigorous psychometric procedures and evaluating practical significance and relationship to theory (Comrey & Lee, 1992).

Future research directions include continued validity testing and hypothesis testing. Replicability of the four factors when using random sampling will ensure that the factors are not sample specific. The relationship of the teaching to global readiness scale to the Cross Cultural Adaptability Inventory (CCAI; Kelley & Myers, 1992) and the Intercultural Development Inventory (IDI; Hammer, Bennett & Wiseman, 2003) can be tested for continued external validity testing and also to assess how internationalizing preservice teacher education translates to classroom practice. Research has shown that teachers who believe that global education is important may not be teaching global education (Rapoport, 2010). The relationship of the teaching for global readiness scale and the Teacher Efficacy Scale (Gibson & Dembo, 1984) and Teacher Locus of Control Scale (Hall, Smitley, Villeme & Schwartz, 1980) could illuminate why teachers who believe in global education may not be practicing global ready teaching. To examine teaching for global readiness at the state

level, the scale can be administered using random cluster sampling by district. Resulting data can be analyzed in order to generalize the existing condition of teaching for global readiness practices in North Carolina, Kentucky, and other states that have adopted global readiness as a goal for all students.

**Implications for Policy.** In an age of high stakes testing focused on literacy and mathematics, global education may not receive priority (Noddings, 1999). The state of North Carolina has made global education a priority. This study was timely because currently the North Carolina professional standards for teachers include teaching for global readiness as part of teacher evaluations (North Carolina State Board of Education, 2013). North Carolina is also among the first states to initiate a Global Ready School designation program and the first state to issue Global Ready badges for teachers (for more information see <http://www.dpi.state.nc.us/docs/globaled/actions/gedb-implement-guide.pdf> ). These global ready badges commenced in January 2015 and are microcredentials intended to demonstrate a teacher's new literacies and global competences. North Carolina, as well as other states that follow suit, can potentially utilize the teaching for global readiness scale (TGRS) as part of microcredential or school-designation programs. The scale could be utilized for awareness building, planning purposes, and assessment of growth over time. While this study focused on individual teacher practices, qualitative data indicated that teachers felt global education was not currently part of the standard course of study and that is why teachers perceived they integrated global learning with the existing curriculum. Future research could address incorporating global readiness skills, knowledge, and dispositions in the standard curriculum for K-12.



**Implications for Practice.** A potential outcome of this study is a theoretically grounded definition and common language around the construct. The TGRS offers a free and accessible tool that has the potential to contribute to teachers' practices. The results point to the importance of being locally situated but globally connected, in other words the importance of cultivating a community of learners inside the classroom and facilitating experiences where students interact with diverse others outside the classroom (face-to-face or virtually). Teachers will be able to use the data collected on TGRS to self-assess strong and weak factors, to set professional development goals, to garner appropriate professional development, to show growth on professional standards, and as part of the process to earn global ready teacher badges. In addition, data can be examined for planning and formative evaluation of global education professional development at the school level. The TGRS can be used for school-wide assessment and as part of global education training evaluations. Principals can administer the scale to the staff as a needs assessment or before and after staff development as one measure of program effectiveness.

At the higher education level, the scale can be employed to inform teacher education. The TGRS collects data on teaching critical literacy skills and dispositions, situating practice for the people and place of instruction, integrating global learning with the curriculum, and utilizing community and technology resources to provide students with transactional learning experiences. At the undergraduate level, TGRS holds the potential to bring awareness to pre-service teachers as to practices that can promote students' global readiness. Teacher educators with in-service teachers can use the data to gauge where teachers need the most support and design lesson plans accordingly.

## **Conclusion**

The goal for the teaching for global readiness scale was to target the key instructional practices that help prepare students for a globally interconnected world. The inductive approach to target these practices was theory-driven and data-driven and utilized the strengths of both qualitative and quantitative methods. Now that the scale is developed, it can contribute to the field of global education in several ways. The study can inform education researchers, state and district policy-makers, and school administrators. Furthermore, the study can inform teachers on practices that promote teaching for global readiness, hopefully leading to global readiness for all students. This project addressed the need for the teaching for global readiness scale, shared related research, described the development of the instrument, evaluated the validity and reliability of the instrument, and considered the prospective contribution of the teaching for global readiness scale.

This study is significant as global education is an increasing concern, not only in North Carolina, but nationally as well as internationally. The results contribute to emerging literature by providing an array of teacher practices that promote global readiness knowledge, skills, and dispositions. Future research should continue to investigate instruction as well as student outcomes associated with teaching for global readiness.

## REFERENCES

- Abu El-Haj, T. R. (2007). "I was born here, but my home, it's not here": Educating for democratic citizenship in an era of transnational migration and global conflict. *Harvard Educational Review*, 77(3), 285-316.
- Alfaro, C., & Quezada, R. L. (2010). International teacher professional development: Teacher reflections of authentic teaching and learning experiences. *Teaching Education*, 21(1), 47-59.
- Allen, L. Q. (2013). Teachers' beliefs about developing language proficiency within the context of study abroad. *System*, 41(1), 134-148.
- Al-Maamari, S. (2014). Education for developing a global Omani citizen: Current practices and challenges. *Journal of Education and Training Studies*, 2(3), 108-117.
- American Psychological Association. (2014). *Standards for educational and psychological testing*. Washington, DC: Authors.
- Andreotti, V. (2006). Soft versus critical global citizenship education. *Policy & Practice - A Development Education Review*, 3. Retrieved from <http://www.developmenteducationreview.com/issue3-focus4?page=show>
- Andreotti, V. (2009). Global education in the '21<sup>st</sup> century': Two different perspectives on the 'post-' of postmodernism. *International Journal of Development Education and Global Learning*, 2(2), 5-22.
- Appiah, K. A. (2006). *Cosmopolitanism: Ethics in a world of strangers*. New York: Norton.
- Appiah, K. A. (2008). Education for global citizenship. *Yearbook of the National Society for The Study of Education*, 107(1), 83-99.

- Apple, M. W. (2011). Global crises, social justice, and teacher education. *Journal of Teacher Education*, 62(2), 222-234.
- Asia Society. (2015). Mapping the Nation. Retrieved from <http://asiasociety.org/mapping-nation>.
- Banks, J. A. (1993). Multicultural education: Historical development, dimensions, and practice. *Review of Research in Education*, 19, 3-49.
- Banks, J. A. (2004). Teaching for social justice, diversity, and citizenship in a global world. *The Educational Forum*, 68(4), 296-305.
- Banks, J. A. (2008). Diversity, group identity, and citizenship education in a global age. *Educational Researcher*, 37(3), 129-139.
- Barker, C. M. (2000). *Education for international understanding*. Carnegie Corporation. Retrieved from <http://www.carnegie.org/fileadmin/Media/Publications/PDF/global.pdf>
- Baumgratz, G. (1995). Language, culture and global competence: an essay on ambiguity. *European Journal of Education*, 30(4), 437-447.
- Beck, U. (2006). *Cosmopolitan vision*. Cambridge, UK: Polity Press.
- Beck, U., & Sznaider, N. (2006). Unpacking cosmopolitanism for the social sciences: a research agenda. *The British Journal of Sociology*, 57(1), 1-23.
- Benson, J., & Clark, F. (1982). A guide for instrument development and validation. *American Journal of Occupational Therapy*, 36(12), 789-800.
- Besnoy, K. D., Maddin, E., Eisenhardt, S., & Steele, E. (2015). The friendship journey:

- Developing global understanding in the middle grades. *Journal of Catholic Education*, 18(2), 44-73.
- Bhawuk, D. P., & Brislin, R. (1992). The measurement of intercultural sensitivity using the concepts of individualism and collectivism. *International Journal of Intercultural Relations*, 16(4), 413-436.
- Bingham, J. (1979). The acceptance of global education scale. (ERIC Document No. ED180857)
- Bosnjak, M., & Tuten, T. L. (2003). Prepaid and promised incentives in web surveys: An experiment. *Social Science Computer Review*, 21(2), 208-217. doi: 10.1177/0894439303251569
- Bottery, M. (2006). Education and globalization: Redefining the role of the educational professional. *Educational Review*, 58(1), 95-113.
- Braskamp, L. A., Braskamp, D. C., Merrill, K. C., & Engberg, M. (2012). The Global Perspective Inventory (GPI): Its purpose, construction, potential uses and psychometric characteristics. Retrieved from <https://gpi.central.edu/supportDocs/manual.pdf>
- Braun, V., & Clarke, V. (2006). Using thematic analysis in psychology. *Qualitative Research in Psychology*, 3(2), 77-101.
- Bremer, D. (2006). Wanted: Global workers. *International Educator*, 15, 40-45.
- Brown, T. A. & Moore, M. T. (2015). Confirmatory factor analysis. In R. H. Hoyle (Ed.), *Handbook of structural equation modeling* (pp. 361-379). New York, NY: Guilford Press.

- Browne, M. W., & Cudeck, R. (1993). Alternative ways of assessing model fit. In K. A. Bollen & J. S. Long (Eds.), *Testing structural equation models* (pgs. 136-162). Newbury Park, CA: Sage.
- Bruner, J. S. (1966). *Toward a theory of instruction*. Cambridge, MA: Harvard University Press.
- Cattell, R. B. (1966). The scree test for the number of factors. *Multivariate Behavioral Research*, 1(2), 245-276.
- Chang, B. (2015). In the service of self-determination: Teacher education, service-learning, and community reorganizing. *Theory Into Practice*, 54(1), 29-38.
- Chen, G. M., & Starosta, W. J. (2000). The development and validation of the intercultural sensitivity scale. *Human Communication*, 3, 1-15.
- Chin, H. K. (Ed.). (2002). *Open doors report on international educational exchange*. New York: Institute of International Education.
- Clark, L. A., & Watson, D. (1995). Constructing validity: Basic issues in objective scale development. *Psychological Assessment*, 7(3), 309-319.
- Clark, V. L., & Badiee, M. (2010). Research questions in mixed methods research. In A. Tashakkori & C. Teddlie (Eds.), *Handbook of mixed methods in social and behavioral research* (2<sup>nd</sup> ed., pp. 275-304). Thousand Oaks, CA: Sage.
- Committee for Economic Development. (2006). Education for global leadership: The importance of international studies and foreign language education for U.S. economic and national security. <http://ced.issueelab.org/resource>
- Cook, R. (2009). *The effects of a short-term teacher abroad program on teachers'*

- perceptions of themselves and their responsibilities as global educators* (Doctoral dissertation). Retrieved from <http://digitalcommons.usu.edu/etd/375>
- Coiro, J. (2003). Reading comprehension on the internet: Expanding our understanding of reading comprehension to encompass new literacies. *The Reading Teacher*, 56(5), 458-464.
- Cope, B., & Kalantzis, M. (Eds.). (2000). *Multiliteracies: Literacy learning and the design of social futures*. London: Routledge
- Cope, B., & Kalantzis, M. (2009). "Multiliteracies": New literacies, new learning. *Pedagogies: An International Journal*, 4(3), 164-195.
- Corbin, J. M., & Strauss, A. (1990). Grounded theory research: Procedures, canons, and evaluative criteria. *Qualitative Sociology*, 13(1), 3-21.
- Costello, A. B., & Osborne, J. W. (2005). Best practices in exploratory factor analysis: Four recommendations for getting the most from your analysis. *Practical Assessment, Research & Evaluation*, 10, (7). Retrieved from <http://pareonline.net/getvn.asp?v=10&n=7>
- Creswell, J. W. (2013). *Qualitative inquiry and research design: Choosing among five approaches*. Thousand Oaks, CA: Sage.
- Creswell, J., & Clark, V. L. P. (2011). *Designing and conducting mixed methods research*. (2<sup>nd</sup> ed.). Thousand Oaks, CA: Sage.
- Cronbach, L. J. (1982). *Designing evaluations of educational and social programs*. San Francisco, CA: Jossey-Bass.
- Cushner, K. (2012). Intercultural competence for teaching and learning. In B. Shaklee &

- S. Baily (Eds.), *A framework for internationalizing teacher education* (pp. 41-59). Lanham, MD: Rowman Littlefield.
- Dagenais, D. (2003). Accessing imagined communities through multilingualism and immersion education. *Journal of Language, Identity, and Education*, 2(4), 269-283.
- Darling-Hammond, L. (2010). *The flat world and education: How America's commitment to equity will determine our future*. New York: Teachers College Press.
- Datta, L. (1997). A pragmatic basis for mixed-method designs. *New Directions for Evaluation*, 74, 33-46.
- Deardorff, D. K. (2006). The identification and assessment of intercultural competence. *Journal of Studies in International Education*, 10(3), 241-266.
- DeCuir-Gunby, J. T. (2008). Designing mixed methods research in the social sciences: A racial identity scale development example. In J. Osborne, (Ed.), *Best practices in quantitative methods* (pp. 125-136). Thousand Oaks, CA: Sage.
- DeCuir-Gunby, J. T., & Schutz, P. (in press). *Developing a mixed methods proposal: A practical guide for beginning researchers*. Thousand Oaks, CA: Sage.
- Delanty, G. (2006). Cosmopolitan imagination: Critical cosmopolitanism and social theory. *Journal of Sociology*, 57(1), 25-47.
- Delanty, G. (2012). The idea of critical cosmopolitanism. In G. Delanty (Ed.), *The Routledge handbook of cosmopolitanism studies* (pp. 38-46). London: Routledge.
- Delores, J., Mufti, I. A., Amagi, I., Carneiro, R., Chung, F., Geremek, B., . . . Nanzhou, Z.



- (1996). *Learning: The treasure within. Report to UNESCO of the Commission on International Education for the Twenty-first Century*. Paris: UNESCO. Retrieved from [http://www.unesco.org/education/pdf/15\\_62.pdf](http://www.unesco.org/education/pdf/15_62.pdf)
- Denzin, N. K., & Lincoln, Y. S. (2005). Introduction: The discipline and practice of qualitative research. In N. K. Denzin & Y. S. Lincoln (Eds.), *The Sage handbook of qualitative research* (3<sup>rd</sup> ed., pp. 1-20). Thousand Oaks, CA: Sage.
- Dillman, D. A., Smyth, J. D., & Christian, L. M. (2008). *Internet, mail, and mixed-mode surveys: The tailored design method* (3rd ed.). New York: Wiley.
- Dillon, D. R., O'Brien, D. G., & Heilman, E. E. (2000). Literacy research in the next millennium: From paradigms to pragmatism and practicality. *Reading Research Quarterly*, 35(1), 10-26.
- Dolby, N. (2004). Encountering an American self: Study abroad and national identity. *Comparative Education Review*, 48(2), 150-173.
- Earth Council. (2002). *The earth charter: Values and principles for a sustainable future*. San Jose, Costa Rica: Authors.
- Eisner, E. W. (1991). What really counts in schools? *Educational Leadership*, 48(5), 10-17.
- Escamilla, K., Aragon, L., & Fránquiz, M. (2009). The transformative potential of a study in Mexico program for US teachers. *Journal of Latinos and Education*, 8(4), 270-289.
- Evans, P. Y. (2004). *A life changing experience: The impact of the educational trip to China by St. Louis area teachers during the summer of 2000* (Doctoral dissertation). Retrieved from ProQuest. (UMI No. 3154259)
- Fantini, A. E. (2000). A central concern: Developing intercultural competence. *SIT*

- Occasional Papers Series: Addressing Intercultural Education, Training & Service*, 1(1), 25-42.
- Fontana, A., & Fey, J. H. (1994). Interviewing: The art of science. In N. Denzin & Y. S. Lincoln (Eds.), *Handbook of qualitative research* (pp. 361-376). Thousand Oaks, CA: Sage.
- Fontana, A., & Fey, J. H. (2003). The interviews: From structured questions to negotiated texts. In N. K. Denzin & Y. S. Lincoln (Eds.), *Collecting and interpreting qualitative materials*, (2<sup>nd</sup> ed., pp. 61-106). Thousand Oaks, CA: Sage.
- Ford, J. K., MacCallum, R. C., & Tait, M. (1986). The application of exploratory factor analysis in applied psychology: A critical review and analysis. *Personnel Psychology*, 59, 291-314.
- Friedman, T. L. (2006). *The world is flat [updated and expanded]: A brief history of the twenty-first century*. New York: Farrar, Strauss and Giroux.
- Gabel, S. (2002). Some conceptual problems with critical pedagogy. *Curriculum Inquiry*, 32(2), 177-201.
- Gardner, H. (2009). *Five minds for the future*. Boston: Harvard Business School Press.
- Gaskin, C. J., & Happell, B. (2014). On exploratory factor analysis: A review of recent evidence, an assessment of current practice, and recommendations for future use. *International Journal of Nursing Studies*, 51(3), 511-521.
- Gay, G. (2002). Preparing for culturally responsive teaching. *Journal of Teacher Education*, 53(2), 106-116.
- Gee, J. P. (1999). The future of the social turn: Social minds and the new capitalism.

- Research on Language & Social Interaction*, 32(1-2), 61-68.
- Gee, J. P. (2008). *Social linguistics and literacies: Ideology in discourses* (3<sup>rd</sup> ed.). New York: Routledge.
- Gibson, S., & Dembo, M. H. (1984). Teacher efficacy: A construct validation. *Journal of Educational Psychology*, 76(4), 569.
- Gilligan, C. (1982). *In a different voice: Psychological theory and women's development*. Cambridge, MA: Harvard Univ.
- Görizt, A. S., & Luthe, S. C. (2013). How do lotteries and study results influence response behavior in online panels? *Social Science Computer Review*, 31(3), 371-385.
- Görizt, A. S., & Wolff, H. G. (2007). Lotteries as incentives in longitudinal web studies. *Social Science Computer Review*, 25(1), 99-110.
- Gough, H. (2014). Globalization and curriculum inquiry: Performing transnational imaginaries. In N. P. Stromquist & K. Monkman (Eds.), *Globalization and education: Integration and contestation across cultures* (2<sup>nd</sup> ed., pp. 87- 100). Lanham, MA: R&L Education.
- Groves, R. M., Fowler, F. J. J., Couper, M. P., Lepkowski, J. M., Singer, E., & Tourangeau, R. (2009). *Survey methodology* (2nd ed.). Hoboken, NJ: Wiley-Interscience.
- Guba, E. G., & Lincoln, Y. S. (1994). Competing paradigms in qualitative research. In N. K. Denzin & Y. S. Lincoln (Eds.), *Handbook of qualitative research* (pp. 105-117). Thousand Oaks, CA: Sage.
- Gutiérrez, K. D., & Penuel, W. R. (2014). Relevance to practice as a criterion for rigor.

- Educational Researcher*, 43(1), 19-23.
- Hadis, B. F. (2005). Why are they better students when they come back? Determinants of academic focusing gains in the study abroad experience. *The Interdisciplinary Journal of Study Abroad*, 11, 57-70.
- Hair, J. F., Jr., Anderson, R. E., Tatham, R. L., & Black, W. C. (1995). *Multivariate data analysis with readings* (4th ed.). Upper Saddle River, NJ: Prentice Hall.
- Hall, B. W., Smitley, W. S., Villeme, M. G., & Schwartz, J. (1980, April). Development and validation of a teacher locus of control scale. Paper presented at the meeting of the National Council on Measurement in Education. Boston, MA.
- Hammer, M. R., Bennett, M. J., & Wiseman, R. (2003). Measuring intercultural sensitivity: The intercultural development inventory. *International Journal of Intercultural Relations*, 27(4), 421-443.
- Hansen, D. T. (2008). Curriculum and the idea of a cosmopolitan inheritance. *Journal of Curriculum Studies*, 40(3), 289-312.
- Hansen, D. T. (2010a). Cosmopolitanism and education: View from the ground. *Teachers College Record*, 112, 1-30.
- Hansen, D. T. (2010b). Chasing butterflies without a net: Interpreting cosmopolitanism. *Studies in Philosophy and Education*, 29(2), 151-166.
- Hansen, D. T. (2011). *The teacher and the world: A study of cosmopolitanism as education*. New York: Routledge.
- Hanvey, R. G. (1982). An attainable global perspective. *Theory into Practice*, 21(3), 162-167.

- Hawkins, M. R. (2014). Ontologies of place, creative meaning making and critical cosmopolitan education. *Curriculum Inquiry*, 44(1), 90-112.
- Hayward, F. M., & Siaya, L. M. (2001). *Public experience, attitudes, and knowledge: A report on two national surveys about international education*. Washington, DC: ACE.
- Heimlich, J. E., & Norland, E. (1994). *Developing teaching style in adult education*. San Francisco, CA: Jossey-Bass.
- Heyneman, S. P. (2002). Defining the influence of education on social cohesion. *International Journal of Educational Policy Research and Practice*, 3(4), 73-97.
- Heyneman, S. P. (2005). Organizations and social cohesion. *Peabody Journal of Education*, 80(4), 1-8.
- Hinkin, T. R. (1998). A brief tutorial on the development of measures for use in survey questionnaires. *Organizational Research Methods*, 1(1), 104-121.
- hooks, b. (1994). *Outlaw culture: Resisting representations*. New York: Routledge.
- Hooper, D., Coughlan, J. & Mullen, M. (2008). Structural equation modeling: Guidelines for determining model fit. *Electronic Journal of Business Research Methods*, 6(1), 53-60.
- Hu, L. T., & Bentler, P. M. (1999). Cut-off criteria for fit indexes in covariance structure analysis: Conventional criteria versus new alternatives. *Structural Equation Modeling*, 6, 1-55.
- Hull, G. A., & Stornaiuolo, A. (2014). Cosmopolitan literacies, social networks, and "proper distance": Striving to understand in a global world. *Curriculum Inquiry*, 44(1), 15-44.
- Hull, G. A., Stornaiuolo, A., & Sahni, U. (2010). Cultural citizenship and cosmopolitan

- practice: Global youth communicate online. *English Education*, 42(4), 331-367.
- Ismail, S. M., & Cazden, C. B. (2005). Struggles for indigenous education and self-determination: Culture, context, and collaboration. *Anthropology and Education Quarterly*, 36, 88-92.
- Jennings, C. (2006). Teacher education: Building a foundation for the global workforce. *AACTE Briefs*, 27(4).
- Jewitt, C., & Kress, G. R. (Ed.). (2003). *Multimodal literacy*. New York: Lang.
- Johnson, J. A. (2005). Ascertaining the validity of individual protocols from web-based personality inventories. *Journal of Research in Personality*, 39(1), 103-129.
- Johnson, R. B., & Onwuegbuzie, A. J. (2004). Mixed methods research: A research paradigm whose time has come. *Educational Researcher*, 33(7), 14-26.
- Johnson, R., Onwuegbuzie, A. J., & Turner, L. (2007). Toward a definition of mixed methods research. *Journal of Mixed Methods Research*, 1, 112-133.
- Johnson, R. B., & Turner, L. A. (2003). Data collection strategies in mixed methods research. In A. Tashakkori & C. Teddlie (Eds.), *Handbook of mixed methods in social and behavioral research* (pp. 297-319). Thousand Oaks, CA: Sage.
- Kaiser, H. F. (1960). The application of electronic computers to factor analysis. *Educational and Psychological Measurement*, 20, 141-151.
- Kalantzis, M., & Cope, B. (Eds.). (2001). *Transformations in language and learning: Perspectives on multiliteracies*. Champagne, IL: Common Ground.
- Kelley, C., & Meyers, J. (1992). *Cross-cultural adaptability inventory (CCAI)*. Yarmouth, ME: Intercultural Press.

- Kim, J., & Mueller, C. W. (1978). *Introduction to factor analysis: What it is and how to do it*. Newbury Park, CA: Sage.
- Kim, S., & Slapac, A. (2015). Culturally responsive, transformative pedagogy in the transnational era: Critical perspectives. *Educational Studies: A Journal of the American Educational Studies Association*, 51(1) 17-27. doi: 10.1080/00131946.2014.983639
- Kress, G. (2009). *Multimodality: A social semiotic approach to contemporary communication*. New York: Routledge.
- Kress, G. (2012). Thinking about the notion of “cross-cultural” from a social semiotic perspective. *Language and Intercultural Communication*, 12(4), 369-385.
- Kruger, D. P., Gandy, S. K., Bechard, A., Brown, R., & Williams, D. (2009). Writing a successful Fulbright group projects abroad grant: Voices from a journey to South Africa. *Journal of Geography*, 108(4-5), 155-162.
- Kymlicka, W. (2004). Justice and security in the accommodation of minority nationalism. In S. May, T. Modood, & J. Squires (Eds.), *Ethnicity, nationalism, and minority rights* (pp. 144-175). Cambridge: Cambridge University Press.
- Ladson-Billings, G. (1995). But that's just good teaching! The case for culturally relevant pedagogy. *Theory into Practice*, 34(3), 159-165.
- Ladson-Billings, G. (2004). Culture versus citizenship: The challenge of racialized citizenship in the United States. In J. A. Banks (Ed.), *Diversity and citizenship education: Global perspectives* (pp. 96-126). San Francisco: Jossey-Bass.
- Laguilles, J. S., Williams, E. A., & Saunders, D. B. (2011). Can lottery incentives boost web

- survey response rates? Findings from four experiments. *Research in Higher Education*, 52(5), 537-553.
- Lankshear, C., & Knobel, M. (2011). *New literacies*. London: McGraw-Hill Education.
- Lea, M. R., & Street, B. V. (2006). The "academic literacies" model: Theory and applications. *Theory into Practice*, 45(4), 368-377.
- Leander, K., & Boldt, G. (2013). Rereading "A Pedagogy of Multiliteracies": Bodies, texts, and emergence. *Journal of Literacy Research*, 45(1), 22-46.
- Learn NC. (2014). Globally Competent Teaching Continuum. Retrieved from <http://www.learnnc.org/lp/editions/global-continuum/>
- Leu, D. J. (2001). Exploring literacy on the internet: Internet Project: Preparing students for new literacies in a global village. *The Reading Teacher*, 54(6), 568-572.
- Leu, D. J. (2002). The new literacies: Research on reading instruction with the Internet. In A. E. Farstrup & S. J. Samuels (Eds.), *What research has to say about reading instruction* (3<sup>rd</sup> ed., pp. 310-336). Newark, DE: IRA.
- Leu, D. J., Kinzer, C. K., Coiro, J., Castek, J., & Henry, L. A. (2013). New literacies and the new literacies of online reading comprehension: A dual level theory. In D. E. Alvermann, N. J. Unrau & R. B. Ruddell (Eds.), *Theoretical models and processes of reading* (6th ed., pp. 1150 – 1181 ). Newark, DE: International Reading Association. Retrieved from [www.reading.org/Libraries/books/IRA-710-chapter42.pdf](http://www.reading.org/Libraries/books/IRA-710-chapter42.pdf)
- Levy, F., & Murnane, R. J. (2004). Education and the changing job market. *Educational Leadership*, 62(2), 1– 4.
- Levy, F., & Murnane, R.J. (2007). How computerized work and globalization shape human



- skill demands. In M. M. Suarez-Orozco (Ed.), *Learning in the global era: International perspectives on globalization and education* (pp. 158-176). Berkeley, CA: University of California Press.
- Lewis, R. D. (1990). *Cross Culture: The Lewis model*. Hampshire, UK: Richard Lewis Communications (Revised ed., 2000).
- Lincoln, Y., & Guba, E. (2000). Paradigmatic controversies, contradictions, and emerging confluences. In N. Denzin and Y. Lincoln (Eds.), *Handbook of qualitative research* (2<sup>nd</sup> ed., pp. 163-188). Thousand Oaks, CA: Sage.
- Lindsay, J. & Davis, V. (2013). *Flattening classrooms, engaging minds: Move to global collaboration one step at a time*. Upper Saddle River, NJ: Pearson.
- Lonsdale, M., & McCurry, D. (2004). *Literacy in the new millennium*. Adelaide, Australia: National Centre for Vocational Education Research.
- Luh, W. M., Olejnik, S., Greenwood, G., & Parkay, F. W. (1991). Psychometric properties of the Wilson Stress Profile for teachers. *Journal of Social Behavior & Personality*, 6(2), 255-270.
- Luke, A., & Freebody, P. (1999). A map of possible practices: Further notes on the four resources model. *Practically Primary*, 4(2), 5-8.
- Mansilla, V. B., & Gardner, H. (2007). In M. M. Suarez-Orozco & C. Stattin (Eds.). *Learning in the global era: International perspectives on globalization and education* (pp. 47-66). Berkeley, CA: University of California Press.
- Mansilla, V. B., & Jackson, A. (2011). *Educating for global competence: Preparing our youth to engage the world*. New York: Asia Society.

- Maira, S. (2004). Youth culture, citizenship and globalization: South Asian Muslim youth in the United States after September 11th. *Comparative Studies of South Asia, Africa and the Middle East*, 24(1), 219-231.
- Manfra, M. M., & Spires, H. A. (2013). Creative synthesis and TPACK: Supporting teachers through a technology and inquiry-rich graduate degree program. *Contemporary Issues in Technology and Teacher Education*, 13(4), 386-418.
- Martens, P., Martens, R., Doyle, M. H., Loomis, J., Fuhrman, L., Furnari, C., & ... Stout, R. (2015). Building intercultural understandings through global literature. *Reading Teacher*, 68(8), 609-617.
- McIntosh, P. (2005). Gender perspectives on educating for global citizenship. In N. Noddings (Ed.), *Educating citizens for global awareness* (pp. 22-39). New York: Teachers College Press.
- McLaughlin, M., & DeVoogd, G. L. (2004). *Critical literacy: Enhancing students' comprehension of text*. New York, NY: Scholastic.
- Meade, A. W., & Craig, S. B. (2012). Identifying careless responses in survey data. *Psychological Methods*, 17(3), 437.
- Merryfield, M. M. (1997). *Preparing teachers to teach global perspectives. A handbook for teacher educators*. Thousand Oaks, CA: Corwin.
- Merryfield, M. M. (2000). Why aren't teachers being prepared to teach for diversity, equity, and global interconnectedness? A study of lived experiences in the making of multicultural and global education. *Teaching and Teacher Education*, 16(4), 429-443.
- Merryfield, M. M. (2002). The difference a global educator can make. *Educational*

- Leadership*, 60(2), 19-21.
- Merryfield, M. M. (2008). Scaffolding social studies for global awareness. *Social Education*, 72(7), 363-366.
- Merryfield, M. M., Lo, J. T. Y., Po, S. C., & Kasai, M. (2008). Worldmindedness: Taking off the blinders. *Journal of Curriculum and Instruction*, 2(1), 6-20.
- Messer, B. L., & Dillman, D. A. (2011). Surveying the general public over the Internet using address-based sampling and mail contact procedures. *Public Opinion Quarterly*, 75(3), 429-457.
- Messick, S. (1995). Standards of validity and the validity of standards in performance assessment. *Educational Measurement: Issues and Practices*, 14, 5-8.
- Mikulec, E. (2014). Internationalization and teacher education: What dispositions do teachers need for global engagement? *Education in a Changing Society*, 1, 5-13.
- Miller L. E., & Smith, K. (1983). Handling non-response issues. *Journal of Extension On-line*, 21(5). Available at: <http://www.joe.org/joe/1983september/83-5-a7.pdf>
- Mills, K. A. (2006). “We’ve been wastin’ a whole million watchin’ her doin’ her shoes”: Situated practice within a pedagogy of multiliteracies. *The Australian Educational Researcher*, 33(3), 13-32.
- Mills, K. A. (2010). A review of the “digital turn” in the new literacy studies. *Review of Educational Research*, 80(2), 246-271.
- Moffat, R. (n.d.). What is global competency? Retrieved from NAFSA website: [http://www.nafsa.org/\\_/File/\\_/global\\_competency\\_2.pdf](http://www.nafsa.org/_/File/_/global_competency_2.pdf)
- Moll, L. C., Amanti, C., Neff, D., & Gonzalez, N. (1992). Funds of knowledge for teaching:

- Using a qualitative approach to connect homes and classrooms. *Theory into Practice*, 31(2), 132-141.
- Morais, D. B., & Ogden, A. C. (2011). Initial development and validation of the global citizenship scale. *Journal of Studies in International Education*, 15(5), 445-466.
- Morrell, E. (2002). Toward a critical pedagogy of popular culture: Literacy development among urban youth. *Journal of Adolescent & Adult Literacy*, 46(1), 72-77.
- Myers, J., & Eberfors, F. (2010). Globalizing English through intercultural critical literacy. *English Education*, 42(2), 148-170.
- Myers, K. K., & Oetzel, J. G. (2003) Exploring the dimensions of organizational assimilation: Creating and validating a measure. *Communication Quarterly*, 51(4), 438-457.
- NAFSA: Association of International Educators. (2003). *An international education agenda for the United States: Public policy, priorities, recommendations*. Washington, DC: Author.
- National Academy of Engineering. (2015). NAE grand challenges for engineering. Retrieved from <http://www.engineeringchallenges.org/>
- National Governors Association, & Council of Chief State School Officers. (2010). *Common Core State Standards*. Washington, DC: Authors.
- New London Group. (1996). A pedagogy of multiliteracies: Designing social futures. *Harvard Educational Review*, 66(1), 60-92.
- Nguyen, D. (2008). *In between worlds: How Vietnamese immigrant youth construct social,*

- cultural, and national identifications* (Unpublished doctoral dissertation). University of Washington, Seattle.
- Noddings, N. (Ed.). (2005). *Educating citizens for global awareness* (pp. 1-4). New York: Teachers College Press.
- North Carolina State Board of Education. (2013). *Preparing students for the world: Final report of the State Board of Education's Task Force on Global Education*. Retrieved from <http://www.dpi.state.nc.us/docs/globaled/final-report.pdf>.
- Norwegian Social Science Data Services. (2013). European Social Survey Education Net. Retrieved from <http://essedunet.nsd.uib.no/cms/topics/immigration/2/9.html>
- Nunnally, J. C. (1978). *Psychometric theory*. New York: McGraw-Hill.
- Nussbaum, M. (1996). Patriotism and cosmopolitanism. In M. Nussbaum & J. Cohen (Eds.), *For the love of country: Debating the limits of patriotism*. Cambridge MA: Beacon Press.
- O'Connor, K., & Zeichner, K. (2011). Preparing US teachers for critical global education. *Globalisation, Societies and Education*, 9(3-4), 521-536.
- Ogaz, C. P. (2000). *Towards a post-colonial education: Subjectivity, pedagogy, and cultural critique* (Doctoral dissertation). Retrieved from ProQuest. (UMI No. 3003209)
- Onwuegbuzie, A. J., & Johnson, R. B. (2006). The validity issue in mixed research. *Research in the Schools*, 13(1), 48-63.
- Onwuegbuzie, A. J., & Leech, N. L. (2006). Linking research questions to mixed methods data analysis procedures. *The Qualitative Report*, 11(3), 474-498.
- Onwuegbuzie, A. J., & Leech, N. L. (2007). Validity and qualitative research: An oxymoron?

- Quality & Quantity*, 41(2), 233-249.
- Orfield, G., & Frankenberg, E. (2014). Increasingly segregated and unequal schools as courts reverse policy. *Educational Administration Quarterly*, 50(5), 718-734.
- Onwuegbuzie, A., & Mallette, M. (2011). Mixed research in literacy research. In N. Duke & M. Mallette (Eds.), *Literacy research methodologies* (pp. 301-330). New York: Guildford.
- Orozco-Domoe, J. S. (2015). Journey to global competence: Learning languages, exploring cultures, transforming lives. Retrieved from <http://www.csctfl.org/documents/2015Report/Chapter%204.pdf>
- Osborne, J. W. (2012). *Best practices in data cleaning: A complete guide to everything you need to do before and after collecting your data*. Thousand Oaks, CA: Sage.
- Pajares, M. F. (1992). Teachers' beliefs and educational research: Cleaning up a messy construct. *Review of educational research*, 62(3), 307-332.
- Parkhouse, H., Glazier, J., Tichnor-Wagner, A., & Montana Cain, J. (2015). From local to global: Making the leap in teacher education. *International Journal of Global Education*, 4(2), 10-29.
- Partnership for 21<sup>st</sup> Century Skills. (2014). *Global ready teacher competency framework: Standards and indicators*. Retrieved from <http://www.p21.org/our-work/global-education>
- Patterson, T. (2013). *Stories of self and other: Four in-service social studies teachers reflect on their international professional development* (Doctoral dissertation). Retrieved from [http://digitalcommons.sacredheart.edu/ced\\_fac/112](http://digitalcommons.sacredheart.edu/ced_fac/112)

- Pike, G. (2015). Re-imagining global education in the neoliberal age. In R. Reynolds, D. Bradbery, J. Brown, K. Carroll, D. Donnelly, K. Ferguson-Patrick, & S. Macqueen (Eds.), *Contesting and constructing international perspectives in global education* (pp. 11-25). Rotterdam, the Netherlands: Sense. Retrieved from <https://www.sensepublishers.com/media/2270-contesting-and-constructing-international-perspectives-in-global-education.pdf#page=20>
- Ponterotto, J. G., Baluch, S., Greig, T., & Rivera, L. (1998). Development and initial score validation of the teacher multicultural attitude survey. *Educational and Psychological Measurement, 58*(6), 1002-1016.
- Quezada, R. L. (2005). "Beyond educational tourism": Lessons learned while student teaching abroad. *International Education Journal, 5*(4), 458-465.
- Quezada, R. L., & Alfaro, C. (2007). Biliteracy teachers' self-reflections of their accounts while student teaching abroad: Speaking from "the other side." *Teacher Education Quarterly, 34*(1), 95-113.
- Radhakrishna, R., & Doamekpor, P. (2008). Strategies for generalizing findings in survey research. *Journal of Extension, 46*(2), 1-4.
- Rapoport, A. (2010). We cannot teach what we don't know: Indiana teachers talk about global citizenship education. *Education, Citizenship and Social Justice, 5*(3), 179-190.
- Reimers, F. (2009). "Global competency" is imperative for global success. *Chronicle of Higher Education, 55*(21), A29.
- Reimers, F. (2010). Educating for global competency. In J. E. Cohen & M. Malin (Eds.),

- International perspectives on the goals of universal basic and secondary education*, (pp. 183-200). New York: Routledge.
- Rizvi, F. (2008). Epistemic virtues and cosmopolitan learning. *The Australian Educational Researcher*, 35(1), 17-35.
- Ruben, B. D. (1976). Assessing communication competence for intercultural communication adaptation. *Group and Organization Studies*, 1(3), 334-354.
- Said, E. W. (1985). Orientalism reconsidered. *Cultural Critique*, 56(1), 89-107.
- Sass, D. (2011). Testing measurement invariance and comparing latent factor means within a confirmatory factor analysis framework. *Journal of Psychoeducational Assessment*, 29(4), 347-363.
- Sass, D. A., & Schmitt, T. A. (2010). A comparative investigation of rotation criteria within exploratory factor analysis. *Multivariate Behavioral Research*, 45(1), 73-103.
- Schmitt, T. A. (2011). Current methodological considerations in exploratory and confirmatory factor analysis. *Journal of Psychoeducational Assessment*, 29(4), 304-321.
- Schukar, R. (1993). Controversy in global education lessons for teacher educators. *Theory into Practice*, 32(1), 52-57.
- Scott, J. (2009). The politics of venture philanthropy in charter school policy and advocacy. *Educational Policy*, 23(1), 106-136. doi:10.1177/089590480832831
- Siegel, M., Kontovourki, S., Schmier, S., & Enriquez, G. (2008). Literacy in motion: A case study of a shape-shifting kindergartener. *Language Arts*, 86(2), 89-98.
- Sinicrope, C., Norris, J., & Watanabe, Y. (2007). Understanding and assessing intercultural



- competence: A summary of theory, research, and practice. *Second Language Studies*, 26(1), 1-58.
- Smiles, R. V. (2001). A world-class education: Rewards abound for those who dare to teach or study abroad. *Black Issues in Higher Education*, 18, 18-27.
- Smith, W. C. (2014). The global transformation toward testing for accountability. *Education Policy Analysis Archives*, 22(116), 1-30.
- Spector, H. (2014). The who and the what of educational cosmopolitanism. *Studies in Philosophy and Education*, 34(4), 1-18. doi: 10.1007/s11217-014-9441-4
- Spires, H. A., Chang, Y., Bot, S., & Himes, M. (2015). Embracing project based inquiry and multimodality: A cross-cultural collaboration between Chinese and US students. Paper presented at The Learner, Madrid, Spain.
- Spires, H., & Estes, T. (2002). Reading in web-based learning environments. In C. Collins Block & M. Pressley (Eds.), *Comprehension instruction: Research-based best practices* (pp. 115-125). New York, NY: Guilford Press.
- Spring, J. (2008). Research on globalization and education. *Review of Educational Research*, 78(2), 330–363.
- Stewart, V. (2007). Becoming citizens of the world. *Educational Leadership*, 64(7), 8-14.
- Stewart, V. (2012). *A world-class education: Learning from international models of excellence and innovation*. Arlington, VA: ASCD.
- Stitzlein, S. M., & West, C. K. (2014). New forms of teacher education: Connections to charter schools and their approaches. *Democracy and Education*, 22(2), 2.
- Stone, E. F. (1978). *Research methods in organizational behavior*. Glenwood, IL: Foresman.

- Stornaiuolo, A., & LeBlanc, R. J. (2014). Local literacies, global scales: The labor of global connectivity. *Journal of Adolescent & Adult Literacy*, 58(3), 192-196.
- Street, B. (2003). What's "new" in New Literacy Studies? Critical approaches to literacy in theory and practice. *Current Issues in Comparative Education*, 5(2), 77-91.
- Suarez-Orozco, M. M. (2001). Globalization, immigration, and education. the research agenda. *Harvard Educational Review*, 71(3), 345-365.
- Sussmuth, R. (2007). On the need for teaching intercultural skills: Challenges for education in a globalizing world. In M. M. Suarez-Orozco & C. Stattin (Eds.), *Learning in a global era: International perspectives on globalization and education* (pp. 195-212). Berkeley: University of California Press.
- Tabachnick, B. G., & Fidell, L. S. (2001). *Using multivariate statistics* (5<sup>th</sup> ed.) Boston, MA: Pearson.
- Thurstone, L. L. (1947). *Multiple factor analysis*. Chicago, IL: University of Chicago Press.
- Tourangeau, R., Conrad, F. G., & Couper, M. P. (2013). *The science of web surveys*. New York: Oxford University Press.
- Tourangeau, R., Rips, L. J., & Rasinski, K. (2000). *The psychology of survey response*. New York: Cambridge University Press.
- Tracey, D. H., & Morrow, L. M. (2012). *Lenses on reading: An introduction to theories and models*. New York: Guilford Press.
- Tucker, L. R., & Lewis, C. (1973). A reliability coefficient for maximum likelihood factor analysis. *Psychometrika*, 38(1), 1-10.
- Tye, K. A. (2014). Global education: A worldwide movement. An update. *Policy Futures in*

- Education*, 12(7), 855-871.
- Union, C., & Green, T. (2013). The use of Web 2.0 technology to help students in high school overcome ethnocentrism during global education projects: A cross-cultural case. *The Georgia Social Studies Journal*, 3(3), 109-124.
- U.S. Census. (2011). Retrieved from <http://quickfacts.census.gov/qfd/states/00000.html>
- USDOE. (2012). *Succeeding globally through international education and engagement*. Retrieved from <https://www.actfl.org/sites/default/files/international-strategy-2012-16.pdf>
- Valenzuela, A. (2013). Subtractive schooling. In D. J. Flinders & S. J. Thornton (Eds.), *The curriculum studies reader* (p. 289-300). New York: Routledge.
- Valenzuela, J. P., Bellei, C., & Ríos, D. D. L. (2014). Socioeconomic school segregation in a market-oriented educational system: The case of Chile. *Journal of Education Policy*, 29(2), 217-241.
- Van Hoof, H. B., & Verbeeten, M. J. (2005). Wine is for drinking, water is for washing: Student opinions about international exchange programs. *Journal of Studies in International Education*, 9(1), 42-61.
- Vasudevan, L., Kerr, K. R., Hibbert, M., Fernandez, E., & Park, A. (2014). Cosmopolitan literacies of belonging in an after-school program with court-involved youths. *Journal of Adolescent & Adult Literacy*, 57(7), 538-548.
- Velicer, W. F., & Fava, J. L. (1998). Affects of variable and subject sampling on factor pattern recovery. *Psychological Methods*, 3(2), 231-251.
- Vogt, D. S., King, D. W., & King, L. A. (2004). Focus groups in psychological assessment:

- Enhancing content validity by consulting members of the target population.  
*Psychological Assessment*, 16(3), 231-243.
- Vygotsky, L. (1978). *Mind in society: The development of higher psychological processes*.  
Cambridge, MA: Harvard University Press.
- Wahlström, N. (2014). Toward a conceptual framework for understanding cosmopolitanism  
on the ground. *Curriculum Inquiry*, 44(1), 113-132.
- West, C. (2010). Borderless via technology. *International Educator*, 19(2), 24–33.
- Willis, G. B. (2005). *Cognitive interviewing: A tool for improving questionnaire design*.  
Thousand Oaks, CA: Sage.
- Wright, C., & Andreotti, V. (2012). Postcolonial cosmopolitanisms: Towards a global  
citizenship education based on divisive universalism. In V. Andreotti & L. T. M.  
Souza (Eds.) *Postcolonial perspectives on global citizenship education* (pp. 47-67).  
New York: Routledge.
- Zhao, Y. (2010). Preparing globally competent teachers: A new imperative for teacher  
education. *Journal of Teacher Education*, 61(5), 422-431.
- Zhao, Y., Meyers, L., & Meyers, B. (2009). Cross-cultural immersion in China: Preparing  
pre-service elementary teachers to work with diverse student populations in the  
United States. *Asia-Pacific Journal of Teacher Education*, 37(3), 295–317.

**APPENDICES**

Appendix A

**Sequential Exploratory Mixed Methods Design Diagram**

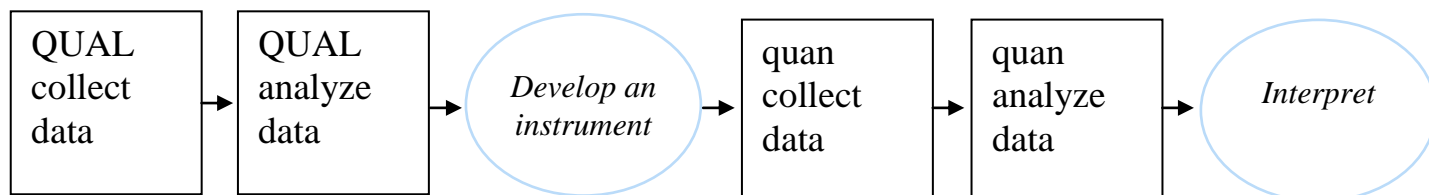

**Procedures:**

- Maximum variation sampling ( $n = 24$ )
- One-on-one semi-structured interviews

**Products:**

- Field notes
- Transcripts

**Procedures:**

- Coding
- Thematic development

**Products:**

- Coded text
- Themes (dimensions of teaching for global readiness)

**Procedures:**

- Consider themes as subscales
- Write 9-11 items for each subscale
- Cognitive interviews ( $n = 6$ )
- Content validity trial ( $n = 22$ )

**Products:**

- Tentative 40 items across 4 subscales (TGR instrument)
- Interview notes

**Procedures:**

- $n = 3,354$  K-12 teachers
- Survey with 2 instruments (TGR, GCS, and demographic items)

**Products:**

- Numerical item scores

**Procedures:**

- Scale reliability
- Hypothesis testing
- Exploratory factor analysis
- Confirmatory factor analysis

**Products:**

- Cronbach's alpha
- Factor loadings
- Measures of fit
- Correlations

**Procedures:**

- Summarize dimensions
- Evidence for construct validity
- Discuss extent to which qualitative dimensions were validated

**Products:**

- Descriptions of dimensions
- Validated instrument to measure dimensions

Note: Diagram based on Myers and Oetzel (2003) as cited in Creswell and Clark (2011).

## Appendix B

**Recruitment Emails**

Dear [Teacher Name],

I am writing to let you know about an opportunity to participate in a research study about teaching students to be ready for our global information world. This study is being conducted by Shea Kerkhoff at North Carolina State University. This study will explore how teachers can help prepare students to be global ready.

You are being asked to participate in this study because of your training on global learning through [organization name]. This study will help other teachers learn how to teach for global readiness.

Teachers who choose to participate in the study will participate in a 45-60 minute interview at NC State, your school or a convenient location of your choosing. After the interview, participants will receive a \$30.00 Amazon gift card to compensate for their time.

*If you would like to volunteer or would like additional information about this study, please e-mail or call Shea Kerkhoff at [snkerkho@ncsu.edu](mailto:snkerkho@ncsu.edu) or 919-995-2623. Agreement to be contacted or a request for more information does not obligate you to participate in any study.*

Thank you for considering this research opportunity.

Sincerely,  
Shea Kerkhoff, M.Ed.  
North Carolina State University

Dear [Expert],

I am writing to ask you to participate in a research study about how to prepare K-12 students to be global ready. This study is being conducted by Shea Kerkhoff at North Carolina State University. This study will explore how teachers can help prepare students to be global ready.

You are being asked to participate in this study because of your expertise on global learning. This study will help K-12 teachers learn how to teach for global readiness.

Teachers who choose to participate in the study will participate in a 45-60 minute interview at a convenient location of your choosing. After the interview, participants will receive a \$30.00 Amazon gift card to compensate for their time.

*If you would like to volunteer or would like additional information about this study, please e-mail or call Shea Kerkhoff at [snkerkho@ncsu.edu](mailto:snkerkho@ncsu.edu) or 919-995-2623. Agreement to be contacted or a request for more information does not obligate you to participate in any study.*

Thank you again for considering this research opportunity.

Sincerely,  
Shea Kerkhoff, M.Ed.  
North Carolina State University



Dear [Teacher Name],

I am writing to let you know about an opportunity to participate in a research study about teaching students to be ready for our global information world. This study is being conducted by Shea Kerkhoff at North Carolina State University. This study will explore how teachers can help prepare students to be global ready.

You are being asked to participate in this study because of your training on global learning through VIF International. This study will help other teachers learn how to teach for global readiness.

Teachers who choose to participate in the study will participate in a 15-20 minute online survey. Participants will be entered into a lottery for a \$200.00 Amazon gift card to compensate for their time.

*If you would like to volunteer or would like additional information about this study, please e-mail or call Shea Kerkhoff at [snkerkho@ncsu.edu](mailto:snkerkho@ncsu.edu) or 919-995-2623. Agreement to be contacted or a request for more information does not obligate you to participate in any study.*

Thank you for considering this research opportunity.

Sincerely,  
Shea Kerkhoff, M.Ed.  
North Carolina State University

## Appendix C

**Interview Protocol**

## Teaching for Global Readiness: An Exploratory Study

Thank you for agreeing to participate in this study. The purpose of this study is to investigate the factors of teaching for global readiness. Your ideas will be used to help develop an instrument to measure teaching for global readiness. Your answers will be confidential. I will use pseudonyms on all notes and reports. Is it okay if I audio record this interview? If you want to stop at any time or stop recording at any time, just let me know. Do you have any questions before we begin?

1. Schools often have mission statements and teachers often have educational philosophies. What is your mission for teaching or philosophy of education?
2. Do you think that global education is important? Why or why not?
3. I define *global readiness* as global citizenship plus the multiliteracies needed in the 21<sup>st</sup> century to participate, collaborate and work in our global knowledge. What do you think students need to learn in order to be global ready?
4. How do you and teacher you know prepare students for a globally connected world?
  - a. How do you prepare students to be global ready?
  - b. How do teacher you work with prepare students to be global ready?
5. What knowledge, skills, or attitudes do teachers need to have for teaching for global readiness?
  - a. Knowledge means what do they need to know.
  - b. Skills means what do they need to be able to do.
  - c. Attitudes means what do they need to believe.
  - d. What else do teachers need to believe or be able to do in order to prepare their students for global readiness?
6. What challenges do you encounter (when working or interacting with Americans / when teaching for global readiness) and how do you overcome them?
7. How would you advise teachers in the US in order to improve Americans' global readiness?
8. Tell me about yourself and your experience in education:
  - a. Gender and racial identity?
  - b. Role?
  - c. Years?
9. Anything else you would like to share?

Probes include:

Can you tell me more about that?

What do you mean by \_\_\_\_\_?

## Appendix D

### **Global Citizenship Scale Example Items**

These items are from the subscale Global Competence

GC.2.1 I unconsciously adapt my behavior and mannerisms when I am interacting with people of other cultures.

GC.2.2 I often adapt my communication style to other people's cultural background.

GC.2.3 I am able to communicate in different ways with people from different cultures.

GC.3.1 I am informed of current issues that impact international relationships.

GC.3.2 I feel comfortable expressing my views regarding a pressing global problem in front of a group of people.

## Appendix E

**Content Validity Trial Results**

## Qualtrics Report

Expert Review of Item Pool Complete Results link: <https://drive.google.com/file/d/0B3-MKV9U7cqZN0JmSFhMMDVfLVk/view?usp=sharing>

*Survey Development Face Validity Trial* Items that Met over 60% Agreement  
**December 3, 2015, 8:32 pm**

**Q1 - I differentiate instruction to meet learners' diverse needs.**

Answer	%	Count
<b>Integrated</b>	<b>20%</b>	<b>4</b>
<b>Situated</b>	<b>65%</b>	<b>13</b>
<b>Critical</b>	<b>15%</b>	<b>3</b>
<b>Transactional</b>	<b>0%</b>	<b>0</b>
<b>Total</b>	<b>100%</b>	<b>20</b>

**Q2 - I integrate global learning experiences into the existing curriculum.**

Answer	%	Count
<b>Integrated</b>	<b>80%</b>	<b>16</b>
<b>Situated</b>	<b>11%</b>	<b>2</b>
<b>Critical</b>	<b>11%</b>	<b>2</b>
<b>Transactional</b>	<b>0%</b>	<b>0</b>

<b>Total</b>	<b>100%</b>	<b>20</b>
Q3 - I facilitate conversations between my students and students from other countries.		
Answer	%	Count
Integrated	5%	1
Situated	5%	1
Critical	5%	1
Transactional	85%	17
Total	100%	20

Q4 - I develop lessons where students use methods of inquiry.

Answer	%	Count
Integrated	11%	2
Situated	11%	2
Critical	65%	13
Transactional	16%	3
Total	100%	20

Q5 - I ask students to critically analyze the source of information.

Answer	%	Count
Integrated	5%	1
Situated	0%	0
Critical	95%	19

Transactional	0%	0
Total	100%	20

**Q6 - I design content-aligned investigations of the world.**

Answer	%	Count
Integrated	70%	14
Situated	21%	4
Critical	0%	0
Transactional	11%	2
Total	100%	20

**Q7 - I facilitate intercultural conversations in my classroom.**

Answer	%	Count
<b>Integrated</b>	<b>0%</b>	<b>0</b>
<b>Situated</b>	<b>16%</b>	<b>3</b>
<b>Critical</b>	<b>5%</b>	<b>1</b>
<b>Transactional</b>	<b>80%</b>	<b>16</b>
<b>Total</b>	<b>100%</b>	<b>20</b>

<b>Q8 - I plan time for students to practice critical literacy skills.</b> Answer	%	Count
<b>Integrated</b>	<b>10%</b>	<b>2</b>
<b>Situated</b>	<b>0%</b>	<b>0</b>
<b>Critical</b>	<b>86%</b>	<b>18</b>
<b>Transactional</b>	<b>5%</b>	<b>1</b>
<b>Total</b>	<b>100%</b>	<b>21</b>

<b>Q9 - I give assessments to evaluate global learning.</b> Answer	%	Count
<b>Integrated</b>	<b>71%</b>	<b>15</b>
<b>Situated</b>	<b>10%</b>	<b>2</b>
<b>Critical</b>	<b>15%</b>	<b>3</b>
<b>Transactional</b>	<b>5%</b>	<b>1</b>
<b>Total</b>	<b>100%</b>	<b>21</b>

<b>Q10 - I guide students to examine their cultural identity.</b> Answer	%	Count
<b>Integrated</b>	<b>10%</b>	<b>2</b>
<b>Situated</b>	<b>15%</b>	<b>3</b>
<b>Critical</b>	<b>71%</b>	<b>15</b>
<b>Transactional</b>	<b>5%</b>	<b>1</b>
<b>Total</b>	<b>100%</b>	<b>21</b>

**Q11 - I guide students to examine other possible perspectives.**

Answer	%	Count
<b>Integrated</b>	<b>5%</b>	<b>1</b>
<b>Situated</b>	<b>5%</b>	<b>1</b>
<b>Critical</b>	<b>67%</b>	<b>14</b>
<b>Transactional</b>	<b>24%</b>	<b>5</b>
<b>Total</b>	<b>100%</b>	<b>21</b>

**Q12 - I ask my students to analyze content from multiple perspectives.**

Answer	%	Count
<b>Integrated</b>	<b>10%</b>	<b>2</b>
<b>Situated</b>	<b>0%</b>	<b>0</b>
<b>Critical</b>	<b>81%</b>	<b>17</b>
<b>Transactional</b>	<b>10%</b>	<b>2</b>
<b>Total</b>	<b>100%</b>	<b>21</b>

**Q13 - I integrate international current events into the curriculum.**

Answer	%	Count
<b>Integrated</b>	<b>71%</b>	<b>15</b>
<b>Situated</b>	<b>15%</b>	<b>3</b>
<b>Critical</b>	<b>10%</b>	<b>2</b>
<b>Transactional</b>	<b>5%</b>	<b>1</b>



<b>Total</b>	<b>100%</b>	<b>21</b>
--------------	-------------	-----------

**Q14 - I invite learners to engage in critical discussions about current events.**

Answer	%	Count
<b>Integrated</b>	<b>0%</b>	<b>0</b>
<b>Situated</b>	<b>10%</b>	<b>2</b>
<b>Critical</b>	<b>76%</b>	<b>16</b>
<b>Transactional</b>	<b>15%</b>	<b>3</b>
<b>Total</b>	<b>100%</b>	<b>21</b>

**Q15 - I utilize synchronous communication tools (e.g., Skype, Google Hangout, FaceTime) for virtual interviews (with experts, community members, etc.) in my classroom.**

Answer	%	Count
<b>Integrated</b>	<b>5%</b>	<b>1</b>
<b>Situated</b>	<b>29%</b>	<b>6</b>
<b>Critical</b>	<b>5%</b>	<b>1</b>
<b>Transactional</b>	<b>62%</b>	<b>13</b>
<b>Total</b>	<b>100%</b>	<b>21</b>

**Q16 - I utilize synchronous communication tools (e.g., Skype, Google Hangout, FaceTime) for international collaboration in my classroom.**

Answer	%	Count
<b>Integrated</b>	<b>0%</b>	<b>0</b>
<b>Situated</b>	<b>29%</b>	<b>6</b>

<b>Critical</b>	<b>5%</b>	<b>1</b>
<b>Transactional</b>	<b>67%</b>	<b>14</b>
<b>Total</b>	<b>100%</b>	<b>21</b>

**Q17 - I utilize asynchronous communication tools (e.g., email, blogs) for international collaboration in my classroom.**

Answer	%	Count
<b>Integrated</b>	<b>5%</b>	<b>1</b>
<b>Situated</b>	<b>29%</b>	<b>6</b>
<b>Critical</b>	<b>0%</b>	<b>0</b>
<b>Transactional</b>	<b>67%</b>	<b>14</b>
<b>Total</b>	<b>100%</b>	<b>21</b>

**Q18 - I teach cross-cultural communication skills.**

Answer	%	Count
<b>Integrated</b>	<b>10%</b>	<b>2</b>
<b>Situated</b>	<b>5%</b>	<b>1</b>
<b>Critical</b>	<b>5%</b>	<b>1</b>
<b>Transactional</b>	<b>81%</b>	<b>17</b>
<b>Total</b>	<b>100%</b>	<b>201</b>

**Q19 - I chose texts for my lessons written by authors from diverse countries.**

Answer	%	Count
<b>Integrated</b>	<b>62%</b>	<b>13</b>
<b>Situated</b>	<b>10%</b>	<b>2</b>
<b>Critical</b>	<b>10%</b>	<b>2</b>
<b>Transactional</b>	<b>20%</b>	<b>4</b>
<b>Total</b>	<b>100%</b>	<b>21</b>

**Q20 - I ask my students to read/view international sources.**

Answer	%	Count
<b>Integrated</b>	<b>62%</b>	<b>13</b>
<b>Situated</b>	<b>10%</b>	<b>2</b>
<b>Critical</b>	<b>19%</b>	<b>4</b>
<b>Transactional</b>	<b>10%</b>	<b>2</b>
<b>Total</b>	<b>100%</b>	<b>21</b>

**Q21 - I ask my students to construct claims based on primary sources.**

Answer	%	Count
<b>Integrated</b>	<b>5%</b>	<b>1</b>
<b>Situated</b>	<b>14%</b>	<b>3</b>
<b>Critical</b>	<b>67%</b>	<b>14</b>
<b>Transactional</b>	<b>14%</b>	<b>3</b>

<b>Total</b>	<b>100%</b>	<b>21</b>
--------------	-------------	-----------

**Q22 - I select materials for my class based on real world issues.**

Answer	%	Count
<b>Integrated</b>	<b>24%</b>	<b>5</b>
<b>Situated</b>	<b>71%</b>	<b>15</b>
<b>Critical</b>	<b>0%</b>	<b>0</b>
<b>Transactional</b>	<b>5%</b>	<b>1</b>
<b>Total</b>	<b>100%</b>	<b>21</b>

**Q23 - I adapt my teaching methods to meet the needs of a culturally diverse student group.**

Answer	%	Count
<b>Integrated</b>	<b>15%</b>	<b>3</b>
<b>Situated</b>	<b>70%</b>	<b>14</b>
<b>Critical</b>	<b>5%</b>	<b>1</b>
<b>Transactional</b>	<b>11%</b>	<b>2</b>
<b>Total</b>	<b>100%</b>	<b>20</b>

**Q24 - I cultivate a classroom environment that values diversity.**

Answer	%	Count
<b>Integrated</b>	<b>15%</b>	<b>3</b>
<b>Situated</b>	<b>70%</b>	<b>14</b>
<b>Critical</b>	<b>5%</b>	<b>1</b>

<b>Transactional</b>	<b>10%</b>	<b>2</b>
<b>Total</b>	<b>100%</b>	<b>20</b>

**Q25 - I take an inventory of the cultures (languages, countries, etc.) represented by my students.**

Answer	%	Count
<b>Integrated</b>	<b>35%</b>	<b>7</b>
<b>Situated</b>	<b>60%</b>	<b>12</b>
<b>Critical</b>	<b>0%</b>	<b>0</b>
<b>Transactional</b>	<b>5%</b>	<b>1</b>
<b>Total</b>	<b>100%</b>	<b>20</b>

**Q26 - I provide a space that allows learners to take risks.**

Answer	%	Count
<b>Integrated</b>	<b>15%</b>	<b>3</b>
<b>Situated</b>	<b>60%</b>	<b>12</b>
<b>Critical</b>	<b>15%</b>	<b>3</b>
<b>Transactional</b>	<b>10%</b>	<b>2</b>
<b>Total</b>	<b>100%</b>	<b>20</b>

**Q27 - I reflect on my own assumptions and biases.**

Answer	%	Count
<b>Integrated</b>	<b>5%</b>	<b>1</b>

<b>Situated</b>	<b>10%</b>	<b>2</b>
<b>Critical</b>	<b>80%</b>	<b>16</b>
<b>Transactional</b>	<b>5%</b>	<b>1</b>
<b>Total</b>	<b>100%</b>	<b>20</b>

**Q28 - I build a repertoire of resources related to global issues.**

Answer	%	Count
<b>Integrated</b>	<b>74%</b>	<b>14</b>
<b>Situated</b>	<b>16%</b>	<b>3</b>
<b>Critical</b>	<b>5%</b>	<b>1</b>
<b>Transactional</b>	<b>5%</b>	<b>1</b>
<b>Total</b>	<b>100%</b>	<b>19</b>

**Q29 - I keep informed on global issues.**

Answer	%	Count
<b>Integrated</b>	<b>65%</b>	<b>13</b>
<b>Situated</b>	<b>15%</b>	<b>3</b>
<b>Critical</b>	<b>15%</b>	<b>3</b>
<b>Transactional</b>	<b>5%</b>	<b>1</b>
<b>Total</b>	<b>100%</b>	<b>20</b>

**Q30 - I am informed through international sources.**

Answer	%	Count
<b>Integrated</b>	<b>60%</b>	<b>12</b>
<b>Situated</b>	<b>20%</b>	<b>4</b>
<b>Critical</b>	<b>15%</b>	<b>3</b>
<b>Transactional</b>	<b>5%</b>	<b>1</b>
<b>Total</b>	<b>100%</b>	<b>20</b>

**Q31 - I take my students on field trips to places within our international community (e.g., mosque, Asian market, Japanese garden)**

Answer	%	Count
<b>Integrated</b>	<b>5%</b>	<b>1</b>
<b>Situated</b>	<b>10%</b>	<b>2</b>
<b>Critical</b>	<b>10%</b>	<b>2</b>
<b>Transactional</b>	<b>75%</b>	<b>15</b>
<b>Total</b>	<b>100%</b>	<b>20</b>

**Q32 - I am aware of the diversity of cultures in my classroom.**

Answer	%	Count
<b>Integrated</b>	<b>25%</b>	<b>5</b>
<b>Situated</b>	<b>65%</b>	<b>13</b>
<b>Critical</b>	<b>0%</b>	<b>0</b>
<b>Transactional</b>	<b>10%</b>	<b>2</b>

<b>Total</b>	<b>100%</b>	<b>20</b>
--------------	-------------	-----------

**Q33 - I display artifacts (e.g., maps, posters, souvenirs) from other countries in my classroom.**

Answer	%	Count
<b>Integrated</b>	<b>60%</b>	<b>12</b>
<b>Situated</b>	<b>25%</b>	<b>5</b>
<b>Critical</b>	<b>10%</b>	<b>2</b>
<b>Transactional</b>	<b>5%</b>	<b>1</b>
<b>Total</b>	<b>100%</b>	<b>20</b>

**Q34 - I provide my students with more than two perspectives on global issues so that they do not see the issue in a polarized or dualistic way.**

Answer	%	Count
<b>Integrated</b>	<b>5%</b>	<b>1</b>
<b>Situated</b>	<b>5%</b>	<b>1</b>
<b>Critical</b>	<b>70%</b>	<b>14</b>
<b>Transactional</b>	<b>21%</b>	<b>4</b>
<b>Total</b>	<b>100%</b>	<b>20</b>

**Q35 - I teach my students to analyze the agenda behind media messages.**

Answer	%	Count
<b>Integrated</b>	<b>5%</b>	<b>1</b>



<b>Situated</b>	<b>5%</b>	<b>1</b>
<b>Critical</b>	<b>80%</b>	<b>16</b>
<b>Transactional</b>	<b>10%</b>	<b>2</b>
<b>Total</b>	<b>100%</b>	<b>20</b>

**Q36 - I bring in speakers from different backgrounds so that my students can listen to different perspectives**

Answer	%	Count
<b>Integrated</b>	<b>5%</b>	<b>1</b>
<b>Situated</b>	<b>32%</b>	<b>6</b>
<b>Critical</b>	<b>5%</b>	<b>1</b>
<b>Transactional</b>	<b>60%</b>	<b>12</b>
<b>Total</b>	<b>100%</b>	<b>20</b>

**Q37 - I teach critical thinking skills.**

Answer	%	Count
<b>Integrated</b>	<b>19%</b>	<b>4</b>
<b>Situated</b>	<b>0%</b>	<b>0</b>
<b>Critical</b>	<b>76%</b>	<b>16</b>
<b>Transactional</b>	<b>5%</b>	<b>1</b>
<b>Total</b>	<b>100%</b>	<b>21</b>

## Appendix F

**Informed Consent Form for Research**

Teaching for Global Readiness: An Exploratory Study  
Shea Kerkhoff, M.Ed.

Dr. Hiller Spires, Ph.D.

---

You are being asked to take part in a research study being conducted through North Carolina State University. Your participation in this study is voluntary. You have the right to be a part of this study, to choose not to participate or to stop participating at any time without penalty. The purpose of this research study is to gain a better understanding of teaching students about global issues and preparing them for a global information society. By participating you will receive a \$30.00 gift card. Research studies also may pose risks to those that participate. In this consent form you will find specific details about the research in which you are being asked to participate. If you do not understand something in this form it is your right to ask the researcher for clarification or more information. A copy of this consent form will be provided to you. If at any time you have questions about your participation, do not hesitate to contact the researcher(s) named above.

The study we are conducting involves researching how teachers in Belize, China, and the US think they should teach their students in order to prepare them for a global information society. Each participant will be asked to participate in a 1 hour interview session. The study will take place at your school, or North Carolina State University, or a place that is convenient for you.

The information in the study records will be kept confidential to the full extent allowed by law. Data will be stored securely in a password protected computer and locked office. No reference will be made in oral or written reports which could link you to the study. I will keep all information that I see, hear, or collect confidential and protected. Interviews and researcher notes will be coded and your name will not be recorded on the data, only pseudonyms will be used. Your name or identifying information, such as town and school name, will not appear in any publication. Only if you specify, your voice will be used in research presentations. In the case of an unintentional breach of confidentiality, the researcher will notify you. Taking part in the study is not a job requirement.

If at any time, you have questions about the study or procedures, you may contact Shea Kerkhoff at [snkerkho@ncsu.edu](mailto:snkerkho@ncsu.edu) or 1-919-995-2623. If at any time you wish to stop participating in the study, you may do so. If you feel you have not been treated according to the descriptions in this form, or your rights as a participant in research have been violated during the course of this project, you may contact Deb Paxton, Regulatory Compliance Administrator, Box 7514, NCSU Campus (919/515-4514).

**Consent to Participate**

*“I have read and understand the above information. I have received a copy of this form. I agree to participate in this study with the understanding that I may choose not to participate or to stop participating at any time without penalty or loss of benefits to which I am otherwise entitled.”*

*I agree to my voice being used also \_\_\_\_\_*

**Subject's signature** \_\_\_\_\_ **Date** \_\_\_\_\_

**Printed name** \_\_\_\_\_

**Investigator's signature** \_\_\_\_\_ **Date** \_\_\_\_\_

**Informed Consent for Survey Research****First Email Message**

Dear (Teacher):

I am writing you to ask you to be a part of my research study. I am a Ph.D. student in education at North Carolina State University. The purpose my research study is to gain a better understanding of teaching students about global issues. Would you be willing to take an online survey asking questions about your typical planning and instruction?

By participating in the survey, you could reflect on your own teaching as well as help other teachers learn about global education.

Plus, you will be entered into a lottery to receive a \$200.00 gift card! That could really help with those holiday expenses.

If you have any questions, please email me at [snkerkho@ncsu.edu](mailto:snkerkho@ncsu.edu). You will receive an email with the link to the survey within the next day.

Thanks in advance,

Shea Kerkhoff  
North Carolina State University

## Second Email Message

Dear Teacher:

You are being asked to take part in a research study being conducted through North Carolina State University. You are being asked because of your experience with VIF International. The purpose of this research study is to gain a better understanding of teaching students about global issues and preparing them for a global information society by developing and validating the Teaching for Global Readiness Scale. Participants will take an online survey asking questions about planning and instruction. By participating in the survey, you will help other teachers learn about global education and you will be entered into a lottery to receive a \$200.00 gift card.

Your participation in this study is voluntary. You have the right to be a part of this study, to choose not to participate or to stop participating at any time without penalty. Taking part in the study is not a job requirement. Research studies may pose risks to those that participate. Your name or direct identification information will not be collected.

In this email, you will find a unique link to a survey. You may begin the survey at any time. The survey will remain open for 3 weeks. The survey will take approximately 15 minutes to complete.

If at any time, you have questions about the study or procedures, you may contact Shea Kerkhoff at [snkerkho@ncsu.edu](mailto:snkerkho@ncsu.edu) or (919/995-2623). If you feel your rights as a participant in research have been violated during the course of this project, you may contact Deb Paxton, Regulatory Compliance Administrator, Box 7514, NCSU Campus (919/515-4514).

**Follow this link to the Survey:**

[\\${l://SurveyLink?d=WillSendToSurvey}](#)

Or copy and paste the URL below into your internet browser:

[\\${l://SurveyURL}](#)

Follow the link to opt out of future emails:

[\\${l://OptOutLink?d=Click here to unsubscribe}](#)

Sincerely,  
Shea N. Kerkhoff, M.Ed.  
Dr. Hiller Spires, Ph.D.

### **Survey Beginning Block**

Your participation in this survey is voluntary. The purpose of this survey is to gain a better understanding of teaching students about global issues and preparing them for a global information society.

If you feel your rights as a participant in research have been violated during the course of this project, you may contact Deb Paxton, Regulatory Compliance Administrator, Box 7514, NCSU Campus (919/515-4514).

#### **Consent to Participate**

“I have read and understand the above information. I agree to participate in this study with the understanding that I may choose not to participate or to stop participating at any time without penalty or loss of benefits to which I am otherwise entitled.”

#### **Subject checks yes or no**

### **Third Email Message**

Dear (Recipient's Name):

I am asking for your help because I am conducting research on global learning. I need teachers to complete an online survey telling me about their own teaching experiences. Your participation could help inform your own teaching practices and help other teachers too.

Added bonus, by participating in this survey, you will be entered into a lottery for a \$200 gift card! The survey should take approximately 15 minutes.

Below is your survey link. It will remain open for 1 more week.

#### **Follow this link to the Survey:**

[\\${1://SurveyLink?d=WillSendToSurvey}](#)

Follow the link to opt out of future emails:

[\\${1://OptOutLink?d=Click here to unsubscribe}](#)

Sincerely,

Shea N. Kerkhoff, M.Ed.

North Carolina State University

### Fourth Email Message

Dear (Teacher):

Would you be willing to take an online survey asking questions about teaching during your typical semester in order to help other teachers learn about teaching?

I am a Ph.D. student at North Carolina State University and am conducting research on teaching global education. The purpose my research study is to gain a better understanding of teaching students about global issues. I need your help!

Participating in the survey could inform your own teaching as well as help other teachers learn about teaching.

Plus, you will be entered into a lottery to receive a \$200.00 gift card! If you have any questions, please email me at [snkerkho@ncsu.edu](mailto:snkerkho@ncsu.edu). Below is your survey link. It will remain open for just 3 more days!

**Follow this link to the Survey:**

[\\${1://SurveyLink?d=WillSendToSurvey}](#)

Or copy and paste the URL below into your internet browser:

[\\${1://SurveyURL}](#)

Follow the link to opt out of future emails:

[\\${1://OptOutLink?d=Click here to unsubscribe}](#)

Sincerely,  
Shea N. Kerkhoff, M.Ed.  
North Carolina State University

## Appendix G

## Operational Definitions for Content Validity Trial



## OPERATIONAL DEFINITIONS:

**Integrated** – Including global issues and global learning concepts into the standard course of study *within all* classes K-12.

**Situated** – Understanding that each class is positioned in a particular time and place. Considering the context of each class by building *relationships* and making global education *relevant*. Utilizing *real* world content that is relevant to the students.

**Critical** – Thinking about causes and effects of own actions and society's actions or lack of action. Encouraging students to *question* and analyze themselves, texts, and *society*. Reflexivity as part of teacher practice and instruction for students.

**Transactional** – Providing opportunities for *intercultural dialogue*, not one-way action, but two-way giving and receiving. Facilitating experiences where students *construct* knowledge.

## Appendix H

## Early and Late Respondents Comparison

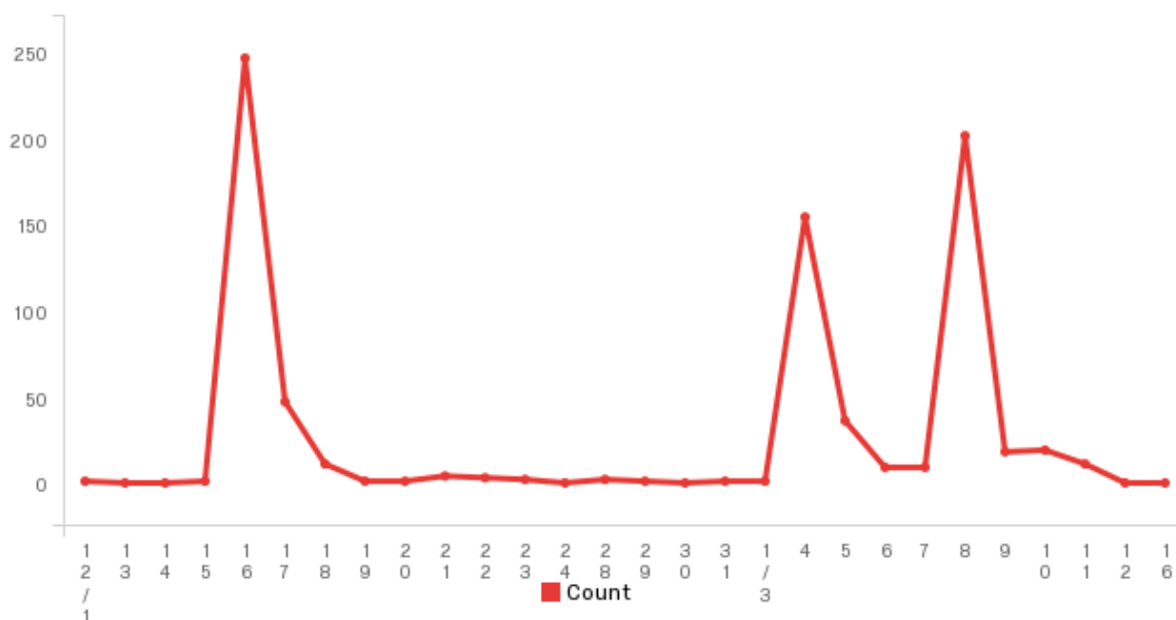

Figure 1. Histogram of response dates from December 1 to January 16.

The sample was split as early responders range December 1 to December 31 ( $n = 270$ ) and late responders range January 1 to January 16 ( $n = 352$ ). There was no significant difference in the variables by month.

Table 1.

Two-sample t-tests with equal variances, by month

Variable	December		January		$t$	df	$p$ (two-tailed)
	M	SD	M	SD			
synchtech	1.72	1.33	1.73	1.34	-0.05	620	0.96
multiplepov	3.73	1.95	3.66	1.92	0.52	620	0.61
integrategl	5.13	1.52	5.09	1.53	0.36	620	0.72
promote equality	4.60	0.59	4.57	0.57	0.73	620	0.46



## Appendix I

## Stata Output of Results

opened on: 20 Jan 2016, 11:46:46

\*\*\*\*\*Preanalysis EFA Sample\*\*\*\*\*

. sum

Variable	Obs	Mean	Std. Dev.	Min	Max
userengage~t	338	11.21893	15.08077	0	119
passportco~t	338	.1213018	.3269617	0	1
passportsi~e	338	.0384615	.1925928	0	1
passportsc~l	338	.8727811	.3337121	0	1
mandarin	338	.0207101	.142623	0	1
spanish	338	.2071006	.405829	0	1
differenti~n	339	6.336283	1.005405	1	7
realworldm~s	339	5.60767	1.301819	2	7
authorsdiv~s	338	3.997041	1.697438	1	7
pbi	339	4.286136	1.666983	1	7
integrateg~m	340	4.985294	1.540913	2	7
designinte~n	339	2.589971	1.653404	1	7
keepinformed	340	5.058824	1.735304	1	7
reflectbia~s	339	5.238938	1.834616	1	7
adaptteach~g	340	6.458824	.9812753	1	7
currenteve~s	340	4.25	1.691337	1	7
convosstud~s	339	2.20354	1.786666	1	7
convosabou~s	339	3.448378	1.942857	1	7
criticalth~g	340	6.464706	.9290088	3	7
crosscultu~n	339	3.834808	2.170778	1	7
providemor~v	338	3.514793	1.808672	1	7
bringspeak~s	340	1.741176	.982477	1	7
intfieldt~s	339	1.235988	.5469684	1	5
assessgl	339	2.949853	1.735589	1	7
readintiso~s	339	2.244838	1.708557	1	7
discussint~s	340	3.279412	1.808254	1	7
reliabilit~e	338	3.352071	1.975445	1	7
analyzemul~v	339	3.643068	1.92447	1	7
primarysou~s	339	3.064897	1.892505	1	7
shareculture	338	3.724852	1.774708	1	7
virtualint~s	339	2.330383	1.835705	1	7
synchtech	338	1.742604	1.376581	1	7
asynchtech	339	1.749263	1.318605	1	7
standardsa~l	339	2.896755	1.798575	1	7
repertoire~s	339	3.516224	1.000977	1	5
valuesdive~y	339	4.439528	.5995815	2	5
promoteseq~y	337	4.554896	.5856275	1	5
inventoryo~s	339	4.129794	.8325641	1	5
examineoth~s	339	4.306785	.6203988	2	5
examinethe~e	338	3.881657	.9037776	1	5

risk	339	4.421829	.5824821	2	5
voice	338	4.5	.5351169	3	5
analyzeage~a	339	3.469027	1.009459	1	5
iaminforme~s	339	3.581121	.9677021	1	5
artifacts	338	3.923077	1.050646	1	5
breakdowns~s	338	4.245562	.6773538	1	5
icanmakead~f	339	3.39233	.8918103	1	5
plantohelp	336	3.175595	.9185321	1	5
tocare	338	3.497041	.8447728	1	5
adaptmybeh~r	338	3.579882	.8338947	1	5
adaptmycomm	338	3.64497	.8739495	1	5
commddiffer~t	339	3.693215	.920018	1	5
issueshat~s	339	3.734513	.8906254	1	5
expressing~w	339	3.410029	1.063106	1	5
opinionlet~r	338	3.378698	1.041465	1	5
countriesv~d	338	4.988166	4.068389	1	16
studenttea~d	295	1.935593	.2458933	1	2
howl~habroad	17	7.411765	2.938087	1	10
studyabroad	294	1.860544	.3470122	1	2
howl~yabroad	39	6.897436	2.845078	1	10
gradelevel	306	1.503268	.7388443	1	3
all	93	1	0	1	1
cte	15	1	0	1	1
ela	51	1	0	1	1
esl	7	1	0	1	1
arts	21	1	0	1	1
socstudies	41	1	0	1	1
math	37	1	0	1	1
science	33	1	0	1	1
pehealth	11	1	0	1	1
sped	23	1	0	1	1
wl	17	1	0	1	1
other	9	1	0	1	1
experience	309	13.00647	6.700937	1	21
degree	306	1.51634	.5198307	1	3
race	304	5.3125	1.726624	1	8
gender	304	1.180921	.4023419	1	3

\*\*\*\*\*EFA\*\*\*\*\*

.factormat

Factor analysis/correlation	Number of obs = 321
Method: principal factors	Retained factors = 4
Rotation: orthogonal varimax (Kaiser off)	Number of params = 150

Factor	Eigenvalue	Difference	Proportion	Cumulative
Factor1	12.44756	9.14542	0.4619	0.4619
Factor2	3.30213	1.05306	0.1225	0.5845
Factor3	2.24907	0.36198	0.0835	0.6679
Factor4	1.88710	0.69161	0.0700	0.7380

\*\*\*\*\*Preanalysis CFA Sample\*\*\*\*\*

.sum

Variable	Obs	Mean	Std. Dev.	Min	Max
userengage~t	287	14.80836	24.99989	0	233
passportco~t	288	.1597222	.3669859	0	1
passportsi~e	288	.0173611	.1308401	0	1
passportsc~l	288	.84375	.3637242	0	1
splashmand~n	288	.0243056	.1542641	0	1
splashspan~h	288	.1666667	.3733267	0	1
differenti~n	288	6.420139	1.085481	0	7
realworldm~s	287	5.655052	1.434893	0	7
authorsdiv~s	287	4.205575	1.740982	0	7
pbi	287	4.400697	1.706548	0	7
integrateg~m	288	5.239583	1.484494	1	7
designintn~n	287	2.560976	1.643681	1	7
keepinformed	287	5.275261	1.723201	1	7
reflectbia~s	287	5.560976	1.673198	1	7
adaptteach~g	289	6.588235	.942809	1	7
currenteve~s	288	4.496528	1.696478	1	7
convosstud~s	288	2.267361	1.836916	1	7
convosconn~s	289	3.411765	1.927506	1	7
criticalth~g	289	6.425606	1.01148	1	7
crosscultu~m	285	4.066667	2.032945	1	7
providemor~v	286	3.744755	1.739497	1	7
bringspeak~s	285	1.750877	.9444282	1	7
intfieldt~s	286	1.300699	.6272744	1	7
assessgl	285	3.049123	1.704708	1	7
readintlso~s	287	2.348432	1.749282	1	7
discussint~s	287	3.445993	1.838699	1	7
reliabilit~e	288	3.611111	2.009077	0	7
analyzemul~v	288	3.753472	1.951946	0	7
primarysou~s	288	3.267361	1.958109	0	7
shareculture	287	3.825784	1.833344	0	7
virtualint~s	287	2.289199	1.765042	1	7
synchtech	287	1.700348	1.28769	1	7
asynchtech	287	1.714286	1.293571	1	7
standardsa~l	286	2.902098	1.736359	1	7
repertoire~s	289	3.612457	.9328033	1	5
valuesdive~y	289	4.456747	.6227999	1	5
promoteseq~y	288	4.618056	.5661352	1	5
inventoryo~s	289	4.266436	.7371219	1	5
examineoth~s	289	4.256055	.7047751	1	5
examinethe~e	289	3.979239	.8895134	1	5
risk	289	4.387543	.6886862	0	5
voice	288	4.482639	.6517551	0	5
analyzeage~a	289	3.435986	1.094598	0	5
iaminforme~s	289	3.6609	.940538	0	5
artifacts	289	3.948097	1.047851	0	5
breakdowns~s	289	4.287197	.7340021	0	5
makediff	288	3.388889	.8960705	1	5

plan	289	3.211073	.9016277	1	5
care	288	3.5	.8430904	1	5
adaptbehave	289	3.602076	.8275607	1	5
adaptcomm	289	3.681661	.7965045	1	5
communicat~f	289	3.799308	.7825347	1	5
currentiss~p	289	3.875433	.8197128	1	5
expressing 288	3.4375	1.013627		1	5
opinionlet~r	289	3.429066	.9696718	1	5
countriesv~d	287	5.013937	3.789913	1	16
studenttea~d	253	1.905138	.2936046	1	2
leng~habroad	23	6.521739	3.273441	1	10
studyabroad	252	1.833333	.3734196	1	2
leng~yabroad	40	7.125	2.652406	1	10
gradelevel	254	1.46063	.7253357	1	3
all	89	1	0	1	1
cte	11	1	0	1	1
ela	51	1	0	1	1
esl	8	1	0	1	1
arts	12	1	0	1	1
socialstud~s	26	1	0	1	1
math	34	1	0	1	1
science	36	1	0	1	1
pehealth	6	1	0	1	1
sped	18	1	0	1	1
wl	10	1	0	1	1
other	11	1	0	1	1
experience	256	13.32813	6.554279	1	21
degree	254	1.523622	.5600616	1	3
race	249	5.080321	1.866938	1	8
gender	250	1.112	.3159991	1	2

\*\*\*\*\*Round 1 CFA\*\*\*\*\*

.sem (CRITICAL -> readintlources discussintlcurrentevents reliabilitysource analyzemultiplepov primarysources analyzeagenda  
keepinformed iaminformedintlources) (SITUATED -> valuesdiversity promotesequality inventoryofcultures examineotherposs  
risk voice breakdownstereotypes) (INTEGRATED -> integrateglwcurriculum realworldmaterials authorsdiversecountries  
crossculturalcomm assessgl repertoireresources adaptteaching convosconnections pbi) (TRANSACTIONAL -> synchtech  
asynchtech convosstudents bringspeakers intlfieldtrips virtualinterviews ), stand

.estat gof

Fit statistic	Value	Description
Likelihood ratio		
chi2_ms	(399) 1132.162	model vs. saturated
p > chi2	0.000	
chi2_bs	(435) 4333.079	baseline vs. saturated
p > chi2	0.000	
Population error		
RMSEA	0.081	Root mean squared error of approximation
90% CI, lower bound	0.075	
upper bound	0.087	
pclose	0.000	Probability RMSEA <= 0.05

Information criteria		
AIC	23885.442	Akaike's information criterion
BIC	24234.381	Bayesian information criterion
Baseline comparison		
CFI	0.812	Comparative fit index
TLI	0.795	Tucker-Lewis index
Size of residuals		
SRMR	0.083	Standardized root mean squared residual
CD	0.999	Coefficient of determination

\*\*\*\*\*Modification indices\*\*\*\*\*

Standard	MI	df	P>MI	EPC	EPC
<b>Measurement</b>					
-----+-----					
readintlsources <-					
INTEGRATED	9.417	1	0.00	.3971817	.2390832
TRANSACTIONAL	13.084	1	0.00	.3716781	.2338107
-----+-----					
discussintlcurrentevents <-					
INTEGRATED	12.897	1	0.00	.4286754	.2436553
TRANSACTIONAL	7.601	1	0.01	.2606202	.1548078
-----+-----					
reliabilitysource <-					
SITUATED	4.872	1	0.03	-.3995895	-.0990681
INTEGRATED	9.404	1	0.00	-.3318629	-.1749667
TRANSACTIONAL	4.050	1	0.04	-.1711756	-.094314
-----+-----					
analyzemultiplepov <-					
TRANSACTIONAL	4.979	1	0.03	-.1673542	-.0948252
-----+-----					
keepinformed <-					
SITUATED	7.473	1	0.01	.6097579	.1769392
INTEGRATED	18.783	1	0.00	.5712338	.3524987
-----+-----					
iaminformedintlsources <-					
SITUATED	22.118	1	0.00	.5710542	.3073659
INTEGRATED	24.819	1	0.00	.3574144	.4090981
TRANSACTIONAL	9.843	1	0.00	.1788026	.2138784
-----+-----					
valuesdiversity <-					
CRITICAL	5.381	1	0.02	-.0747376	-.1128162
-----+-----					
promotesequality <-					
CRITICAL	19.385	1	0.00	-.1297893	-.2136974
INTEGRATED	6.831	1	0.01	-.0750177	-.1388129
TRANSACTIONAL	5.855	1	0.02	-.0552649	-.1068694
-----+-----					
inventoryofcultures <-					
INTEGRATED	5.298	1	0.02	.0948679	.1342606
-----+-----					
examineotherposs <-					
CRITICAL	22.700	1	0.00	.1925857	.2556405
INTEGRATED	6.646	1	0.01	.1013712	.1512258
TRANSACTIONAL	4.600	1	0.03	.0674086	.1050907
-----+-----					

```

voice <-
INTEGRATED      7.852  1  0.01 -.0910834 -.1601991
TRANSACTIONAL   4.517  1  0.03 -.0551685 -.1014028
-----+-----
breakdownstereotypes <-
CRITICAL        12.736  1  0.00 .155377 .2094349
INTEGRATED      5.306  1  0.02 .0975162 .1477219
-----+-----
integrateglwcurriculum <-
CRITICAL        4.175  1  0.04 -.2242444 -.1427621
TRANSACTIONAL   7.341  1  0.01 -.2371302 -.1773052
-----+-----
assessgl <-
SITUATED        5.005  1  0.03 -.4681839 -.1353539
TRANSACTIONAL   7.126  1  0.01 .2742889 .1762289
-----+-----
adapteaching <-
SITUATED        15.203  1  0.00 .5474168 .2876284
TRANSACTIONAL   17.045  1  0.00 -.28386 -.3314609
-----+-----
synchtech <-
CRITICAL        6.262  1  0.01 -.1836028 -.1330482
INTEGRATED      11.835  1  0.00 -.2604411 -.2121022
-----+-----
convosstudents <-
INTEGRATED      5.811  1  0.02 .3228891 .1850327
-----+-----
bringspeakers <-
SITUATED        6.094  1  0.01 .2652684 .1384803
INTEGRATED      13.171  1  0.00 .2391884 .2655335
-----+-----
intlfieldtrips <-
INTEGRATED      4.315  1  0.04 .091949 .1550407

cov(e.readintlsources,e.discussintlcurrentevents) 30.637  1  0.00 .6865941 .3532714
cov(e.readintlsources,e.analyzemultiplepov) 16.863  1  0.00 -.4047042 -.3175137
cov(e.readintlsources,e.iainformedintlsources) 9.712  1  0.00 .2329976 .1916916
cov(e.readintlsources,e.repertoireresources) 4.954  1  0.03 .1480335 .1425567
cov(e.readintlsources,e.adapteaching) 4.869  1  0.03 -.179335 -.1347647
cov(e.discussintlcurrentevents,e.reliabilitysource) 16.257  1  0.00 -.4243126 -.2922039
cov(e.discussintlcurrentevents,e.analyzemultiplepov) 8.535  1  0.00 -.2781847 -.2441599
cov(e.discussintlcurrentevents,e.analyzeagenda) 5.165  1  0.02 .1669997 .1466382
cov(e.discussintlcurrentevents,e.keepinformed) 12.238  1  0.00 .4415574 .2215294
cov(e.discussintlcurrentevents,e.iainformedintlsources) 11.216  1  0.00 .2300524 .211736
cov(e.reliabilitysource,e.analyzemultiplepov) 45.016  1  0.00 .6569027 .6897909
cov(e.reliabilitysource,e.primarysources) 5.077  1  0.02 .2240364 .1922294
cov(e.reliabilitysource,e.keepinformed) 4.783  1  0.03 -.247689 -.148671
cov(e.reliabilitysource,e.iainformedintlsources) 10.379  1  0.00 -.1984092 -.2184767
cov(e.analyzemultiplepov,e.primarysources) 8.684  1  0.00 .2826467 .3090909
cov(e.analyzemultiplepov,e.iainformedintlsources) 15.637  1  0.00 -.2134132 -.2995059
cov(e.analyzemultiplepov,e.valuesdiversity) 8.106  1  0.00 -.073455 -.2274491
cov(e.analyzemultiplepov,e.examineotherposs) 7.216  1  0.01 .0880335 .2049805
cov(e.primarysources,e.keepinformed) 12.249  1  0.00 -.3834417 -.2396872
cov(e.primarysources,e.iainformedintlsources) 10.394  1  0.00 -.192062 -.2202473
cov(e.analyzeagenda,e.keepinformed) 4.684  1  0.03 .1756974 .1344671
cov(e.analyzeagenda,e.iainformedintlsources) 13.438  1  0.00 .1619896 .2274373
cov(e.analyzeagenda,e.examineotherposs) 9.358  1  0.00 .0849296 .1978399
cov(e.keepinformed,e.iainformedintlsources) 21.436  1  0.00 .3527899 .2830111
cov(e.keepinformed,e.integrateglwcurriculum) 8.279  1  0.00 .2908432 .1873933
cov(e.keepinformed,e.realworldmaterials) 15.016  1  0.00 .4437886 .2394317
cov(e.keepinformed,e.adapteaching) 7.344  1  0.01 .2246764 .1646282

```

```

cov(e.iaminformedintlresources,e.breakdownstereotypes) 16.584 1 0.00 .1153514 .253458
cov(e.iaminformedintlresources,e.repertoireresources) 11.406 1 0.00 .1247589 .214911
cov(e.valuesdiversity,e.promotesequality) 68.670 1 0.00 .0890917 .6987334
cov(e.valuesdiversity,e.inventoryofcultures) 5.015 1 0.03 .0330599 .1703461
cov(e.valuesdiversity,e.examineotherposs) 7.238 1 0.01 -.0378187 -.2037404
cov(e.valuesdiversity,e.risk) 9.150 1 0.00 -.0393044 -.2253667
cov(e.valuesdiversity,e.voice) 17.763 1 0.00 -.0494417 -.3261218
cov(e.valuesdiversity,e.crossculturalcomm) 4.953 1 0.03 .0920956 .1532342
cov(e.valuesdiversity,e.pbi) 6.567 1 0.01 -.0866704 -.1784438
cov(e.valuesdiversity,e.convosstudents) 3.963 1 0.05 .0829138 .1335746
cov(e.promotesequality,e.examineotherposs) 10.186 1 0.00 -.0410761 -.2422509
cov(e.promotesequality,e.risk) 9.950 1 0.00 -.0375218 -.2355257
cov(e.promotesequality,e.adaptteaching) 12.823 1 0.00 .0734331 .2384224
cov(e.inventoryofcultures,e.risk) 6.581 1 0.01 -.043087 -.1776879
cov(e.inventoryofcultures,e.integrateglwcurriculum) 5.628 1 0.02 .0864223 .1621012
cov(e.examineotherposs,e.breakdownstereotypes) 26.105 1 0.00 .0939122 .342362
cov(e.examineotherposs,e.adaptteaching) 5.447 1 0.02 -.0665139 -.1483418
cov(e.examineotherposs,e.convosconnections) 5.213 1 0.02 .1224741 .1478324
cov(e.risk,e.voice) 88.150 1 0.00 .1247122 .6583785
cov(e.risk,e.integrateglwcurriculum) 4.745 1 0.03 -.0706542 -.1474742
cov(e.risk,e.realworldmaterials) 5.834 1 0.02 .0887218 .1550667
cov(e.voice,e.repertoireresources) 4.153 1 0.04 -.0392055 -.1371924
cov(e.breakdownstereotypes,e.crossculturalcomm) 4.061 1 0.04 -.1148612 -.1293253
cov(e.breakdownstereotypes,e.repertoireresources) 9.217 1 0.00 .076786 .1974881
cov(e.integrateglwcurriculum,e.repertoireresources) 4.173 1 0.04 .1070008 .148041
cov(e.integrateglwcurriculum,e.adaptteaching) 3.958 1 0.05 .1215646 .1312459
cov(e.realworldmaterials,e.authorsdiversecountries) 5.011 1 0.03 .2509913 .1442546
cov(e.realworldmaterials,e.assessgl) 7.608 1 0.01 -.2780527 -.1865208
cov(e.realworldmaterials,e.repertoireresources) 19.884 1 0.00 -.254265 -.2945723
cov(e.realworldmaterials,e.adaptteaching) 10.860 1 0.00 .2254275 .2037959
cov(e.realworldmaterials,e.pbi) 17.056 1 0.00 .4332221 .2718822
cov(e.realworldmaterials,e.convosstudents) 4.347 1 0.04 -.263532 -.1294106
cov(e.authorsdiversecountries,e.assessgl) 9.477 1 0.00 -.3683759 -.2133609
cov(e.authorsdiversecountries,e.pbi) 3.849 1 0.05 .2436098 .1320045
cov(e.authorsdiversecountries,e.bringspeakers) 4.216 1 0.04 .1489257 .1306966
cov(e.assessgl,e.repertoireresources) 5.007 1 0.03 .1374924 .1605227
cov(e.assessgl,e.intfieldtrips) 4.229 1 0.04 .0890754 .1347456
cov(e.repertoireresources,e.adaptteaching) 6.634 1 0.01 -.1050828 -.1653401
cov(e.convosconnections,e.synchtech) 6.270 1 0.01 -.2158985 -.191077
cov(e.convosconnections,e.asynchtech) 3.905 1 0.05 .196899 .1304335
cov(e.convosconnections,e.convosstudents) 75.965 1 0.00 1.500693 .5416816
cov(e.convosconnections,e.virtualinterviews) 8.466 1 0.00 -.375575 -.1976837
cov(e.synchtech,e.asynchtech) 13.562 1 0.00 .2480579 .4043699
cov(e.synchtech,e.virtualinterviews) 6.868 1 0.01 .2523878 .3269056
cov(e.asynchtech,e.bringspeakers) 9.655 1 0.00 -.156259 -.2150298
cov(e.asynchtech,e.intfieldtrips) 11.275 1 0.00 -.1129426 -.2295328
cov(e.bringspeakers,e.intfieldtrips) 54.089 1 0.00 .204309 .4682901

```

EPC = expected parameter change

\*\*\*\*\*Round 2 CFA\*\*\*\*\*

\*\*\*\*remove residuals >1.96\*\*\*\*\*

```

sem (CRITICAL -> discussintlcurrentevents reliabilitysource analyzemultiplepov primarysources analyzeagenda ) (SITUATED -
>valuesdiversity promotesequality inventoryofcultures risk voice breakdownstereotypes examineotherposs) (INTEGRATED ->
integrateglwcurriculum realworldmaterials assessgl repertoireresources pbi)(TRANSACTIONAL -> synchtech asynchtech
bringspeakers intfieldtrips virtualinterviews ), cov (e.valuesdiversity*e.promotesequality e.risk*e.voice
e.reliabilitysource*e.analyzemultiplepov) stand

```

.estat gof

Fit statistic	Value	Description
-----		
Likelihood ratio		
chi2_ms(200)	451.174	model vs. saturated
p > chi2	0.000	
chi2_bs(231)	3290.874	baseline vs. saturated
p > chi2	0.000	
Population error		
RMSEA	0.067	Root mean squared error of approximation
90% CI, lower bound	0.059	
upper bound	0.075	
pclose	0.000	Probability RMSEA <= 0.05

Information criteria		
AIC	15902.808	Akaike's information criterion
BIC	16175.417	Bayesian information criterion

Baseline comparison		
CFI	0.918	Comparative fit index
TLI	0.905	Tucker-Lewis index

Size of residuals		
SRMR	0.064	Standardized root mean squared residual
CD	0.999	Coefficient of determination

\*\*\*\*\*Round 3 CFA\*\*\*\*\*  
 \*\*\*\*\*remove intfieldtrips realworldmaterials\*\*\*\*

.sem (CRITICAL -> discussintcurrentevents reliabilitysource analyzemultiplepov primarysources analyzeagenda ) (SITUATED -> valuesdiversity promotesequality inventoryofcultures risk voice breakdownstereotypes **examineotherposs** ) (INTEGRATED -> integrateglwcurriculum assessgl repertoireresources pbi)(TRANSACTIONAL -> synchtech asynchtech bringspeakers virtualinterviews ), cov (e.valuesdiversity\*e.promotesequality e.risk\*e.voice e.reliabilitysource\*e.analyzemultiplepov) stand

.estat gof

Fit statistic	Value	Description
-----		
Likelihood ratio		
chi2_ms	(161) 304.461	model vs. saturated
p > chi2	0.000	
chi2_bs	(190) 3026.190	baseline vs. saturated
p > chi2	0.000	
Population error		
RMSEA	0.056	Root mean squared error of approximation
90% CI, lower bound	0.047	
upper bound	0.066	
pclose	0.135	Probability RMSEA <= 0.05
Information criteria		
AIC	14489.623	Akaike's information criterion
BIC	14740.424	Bayesian information criterion
Baseline comparison		
CFI	0.949	Comparative fit index
TLI	0.940	Tucker-Lewis index
Size of residuals		
SRMR	0.060	Standardized root mean squared residual
CD	0.999	Coefficient of determination



\*\*\*\*\*Round 4 CFA\*\*\*\*\*  
 \*\*\*\*\*remove bringspeakers\*\*\*\*\*

.sem (CRITICAL -> discussintlcurrentevents reliabilitysource analyzemultiplepov primarysources analyzeagenda ) (SITUATED -> valuesdiversity promotesequality inventoryofcultures risk voice breakdownstereotypes **examineotherposs** ) (INTEGRATED -> integrateglwcurriculum assessgl repertoireresources pbi) (TRANSACTIONAL -> synchtech asynchtech virtualinterviews ), cov (e.valuesdiversity\*e.promotesequality e.risk\*e.voice e.reliabilitysource\*e.analyzemultiplepov) stand

## Likelihood ratio

chi2_ms	(143)	271.908	model vs. saturated
p > chi2		0.000	
chi2_bs	(171)	2926.591	baseline vs. saturated
p > chi2		0.000	

## Population error

RMSEA	0.057	Root mean squared error of approximation
90% CI, lower bound	0.046	
upper bound	0.067	
pclose	0.140	Probability RMSEA <= 0.05

## Information criteria

AIC	13839.532	Akaike's information criterion
BIC	14079.663	Bayesian information criterion

## Baseline comparison

CFI	0.953	Comparative fit index
TLI	0.944	Tucker-Lewis index

## Size of residuals

SRMR	0.055	Standardized root mean squared residual
CD	0.999	Coefficient of determination

\*\*\*\*\*CFA Round 5\*\*\*\*\*

.sem (CRITICAL -> discussintlcurrentevents reliabilitysource analyzemultiplepov primarysources analyzeagenda) (SITUATED -> valuesdiversity promotesequality inventoryofcultures risk voice breakdownstereotypes) (INTEGRATED -> integrateglwcurriculum assessgl repertoireresources pbi) (TRANSACTIONAL -> synchtech asynchtech bringspeakers virtualinterviews ), cov (e.valuesdiversity\*e.promotesequality e.risk\*e.voice e.reliabilitysource\*e.analyzemultiplepov) stand

.estat gof

Fit statistic	Value	Description
-----		
Likelihood ratio		
chi2_ms	(143) 246.909	model vs. saturated
p > chi2	0.000	
chi2_bs	(171) 2787.282	baseline vs. saturated
p > chi2	0.000	
Population error		
RMSEA	0.051	Root mean squared error of approximation
90% CI, lower bound	0.040	
upper bound	0.062	
pclose	0.430	Probability RMSEA <= 0.05
Information criteria		
AIC	14066.468	Akaike's information criterion
BIC	14306.364	Bayesian information criterion
Baseline comparison		

CFI	0.960	Comparative fit index
TLI	0.953	Tucker-Lewis index
Size of residuals		
SRMR	0.061	Standardized root mean squared residual
CD	0.999	Coefficient of determination

\*\*\*\*\*Round 5 CFA\*\*\*\*\*

\*\*\*\*removing bringspeakers\*\*\*\*

.sem (CRITICAL -> discussintcurrentevents reliabilitysource analyzemultiplepov primarysources analyzeagenda) (SITUATED -> valuesdiversity promotesequality inventoryofcultures risk voice breakdownstereotypes) (INTEGRATED -> integrateglwcurriculum assessgl repertoireresources pbi) (TRANSACTIONAL -> synchtech asynchtech virtualinterviews ), cov  
(e.valuesdiversity\*e.promotesequality e.risk\*e.voice e.reliabilitysource\*e.analyzemultiplepov) stand

.estat gof

Fit statistic	Value	Description
-----		
Likelihood ratio		
chi2_ms	(143) 271.908	model vs. saturated
p > chi2	0.000	
chi2_bs	(171) 2926.591	baseline vs. saturated
p > chi2	0.000	
Population error		
RMSEA	0.057	Root mean squared error of approximation
90% CI, lower bound	0.046	
upper bound	0.067	
pclose	0.140	Probability RMSEA <= 0.05
Information criteria		
AIC	13839.532	Akaike's information criterion
BIC	14079.663	Bayesian information criterion
Baseline comparison		
CFI	0.953	Comparative fit index
TLI	0.944	Tucker-Lewis index
Size of residuals		
SRMR	0.055	Standardized root mean squared residual
CD	0.999	Coefficient of determination

## Appendix J

**Polychoric Correlations**

	differentiateinstruction	realworldmaterials
differentiateinstruction	1	
realworldmaterials	0.38330028	1
authorsdiversecountries	0.33036588	0.460802
pbi	0.23296593	0.507255
integrateglwcurriculum	0.24405643	0.49434211
designinternationalcollaboration	0.19790317	0.38271836
keepinformed	0.20706652	0.41111415
reflectbiases	0.1500779	0.31105668
adaptteaching	0.63256522	0.30576567
currentevents	0.16809955	0.47309059
convostudentsandcountries	0.15026608	0.18983979
convoaboutconnections	0.25935127	0.24841682
crossculturalcommunication	0.21034238	0.25828207
providemoretwopov	0.22486902	0.434058
bringspeakers	0.11039892	0.18508744
intlfieldtrips	0.0686743	0.15202922
assessgl	0.20329247	0.31113618
readintlsources	0.02794219	0.14223271
discussintlcurrentevents	0.05582013	0.339586
reliabilitysource	0.03433638	0.2730491
analyzemultiplepov	0.16522878	0.37608897
primarysources	0.07589401	0.2687768
shareculture	0.19257892	0.25658179
virtualinterviews	-0.00028509	0.14437665
synchtech	0.01381357	0.17179999
asynchtech	0.16420514	0.1384633
standardsalignedpbiglobal	0.09051361	0.26435914
repertoireresources	0.25906231	0.28010687
valuesdiversity	0.27560083	0.24306537
promotesequality	0.22909339	0.26258574
inventoryofcultures	0.25086701	0.2315545
examineotherposs	0.27860583	0.26008181
examinetheirculture	0.22784067	0.31480321
risk	0.22773785	0.07934873
voice	0.29321433	0.13013677
analyzeagenda	0.03473248	0.28294571
iaminformedintlsources	0.05402398	0.29626296

artifacts	0.22019224	0.15191409
breakdownstereotypes	0.14833061	0.22426923
	authorsdiversecountries	pbi
authorsdiversecountries	1	
pbi	0.39606991	1
integrateglwcurriculum	0.39056575	0.42045844
designinternationalcollaboration	0.40204111	0.42654709
keepinformed	0.40498183	0.31176269
reflectbiases	0.37588541	0.25783844
adaptteaching	0.24187903	0.16873989
currentevents	0.39069704	0.45435007
convosstudentsandcountries	0.1929066	0.20994684
convosaboutconnections	0.37861105	0.31189168
crossculturalcommunication	0.38985134	0.30640303
providemoretwopov	0.43931233	0.42281916
bringspeakers	0.30640409	0.3186349
intlfieldtrips	0.25893892	0.27422983
assessgl	0.32647959	0.36945455
readintlsources	0.20302791	0.19139953
discussintlcurrentevents	0.22114903	0.33373023
reliabilitysource	0.18346631	0.3053833
analyzemultiplepov	0.27502865	0.39366255
primarysources	0.23925138	0.33987624
shareculture	0.4041476	0.34957587
virtualinterviews	0.1627461	0.3014764
synchtech	0.16941352	0.42130098
asynchtech	0.18581821	0.31857914
standardsalignedpbiglobal	0.33706819	0.41735303
repertoireresources	0.34642057	0.36560643
valuesdiversity	0.25892129	0.19484914
promotesequality	0.15920644	0.19674855
inventoryofcultures	0.2801883	0.20743045
examineotherposs	0.28555577	0.3641345
examinetheirculture	0.3740577	0.36886872
risk	0.19682737	0.2389381
voice	0.24736583	0.26714275
analyzeagenda	0.20889202	0.30381458
iaminformedintlsources	0.34116161	0.28016028
artifacts	0.28394986	0.16644269
breakdownstereotypes	0.25433507	0.11603195

	integrateglwcurriculum	designintlcollaboration
integrateglwcurriculum	1	
designinternationalcollaboration	0.45499703	1
keepinformed	0.42567415	0.34669776
reflectbiases	0.28268086	0.25121066
adaptteaching	0.20693812	0.17582676
currentevents	0.5356567	0.48875759
convosstudentsandcountries	0.25855567	0.46901161
convosaboutconnections	0.41644027	0.36996077
crossculturalcommunication	0.3962493	0.40961509
providemoretwopov	0.51652791	0.46253229
bringspeakers	0.24586956	0.30762805
intlfieldtrips	0.29501893	0.33502448
assessgl	0.48242132	0.50870497
readintlsources	0.30050591	0.23553333
discussintlcurrentevents	0.36636043	0.27064759
reliabilitysource	0.25341875	0.22035479
analyzemultiplepov	0.35821085	0.25552385
primarysources	0.24346035	0.27498137
shareculture	0.35274267	0.38629574
virtualinterviews	0.26897794	0.31374678
synchtech	0.25650732	0.41823281
asynchtech	0.28851822	0.43769832
standardsalignedpbiglobal	0.37305981	0.38922625
repertoireresources	0.53333965	0.50005374
valuesdiversity	0.31951111	0.15021311
promotesequality	0.3210741	0.11345806
inventoryofcultures	0.18572229	0.09509976
examineotherposs	0.3174003	0.16909859
examinetheirculture	0.42072926	0.3857561
risk	0.20229937	0.0573447
voice	0.19399884	0.11809772
analyzeagenda	0.17686757	0.33987173
iaminformedintlsources	0.34240522	0.39041269
artifacts	0.4115524	0.34583998
breakdownstereotypes	0.27527154	0.25517862
	keepinformed	reflectbiases
keepinformed	1	
reflectbiases	0.47090827	1
adaptteaching	0.163373	0.29927283
currentevents	0.53844067	0.26571663

convosstudentsandcountries	0.13468091	0.08281998
convosaboutconnections	0.33283646	0.2452428
crossculturalcommunication	0.31335253	0.34362439
providemoretwopov	0.54502089	0.35332688
bringspeakers	0.20563532	0.11625127
intlfieldtrips	0.25012858	0.10209379
assessgl	0.3760291	0.21065969
readintlsources	0.40119662	0.14580835
discussintlcurrentevents	0.53047254	0.24704914
reliabilitysource	0.37061544	0.32541184
analyzemultiplepov	0.38156483	0.35449801
primarysources	0.31847086	0.25076912
shareculture	0.29693261	0.29869125
virtualinterviews	0.11044368	0.07137584
synchtech	0.17712535	0.04566663
asynchtech	0.22767689	0.08808297
standardsalignedpbiglobal	0.28682623	0.24669559
repertoireresources	0.3727388	0.27794405
valuesdiversity	0.33397014	0.32628114
promotesequality	0.24346712	0.27558689
inventoryofcultures	0.2968413	0.35024334
examineotherposs	0.3764002	0.42413729
examinetheirculture	0.29749774	0.31813838
risk	0.2473405	0.27092402
voice	0.1948809	0.28324136
analyzeagenda	0.38585325	0.16385908
iaminformedintlsources	0.5640928	0.35738978
artifacts	0.26855465	0.20111412
breakdownstereotypes	0.3336067	0.38159749
	adaptteaching	currentevents
adaptteaching	1	
currentevents	0.15212922	1
convosstudentsandcountries	0.0569671	0.38796013
convosaboutconnections	0.17818101	0.44804933
crossculturalcommunication	0.23560673	0.37539397
providemoretwopov	0.13918966	0.65947024
bringspeakers	0.09132214	0.29085176
intlfieldtrips	0.00464518	0.34772102
assessgl	0.2250239	0.5651124
readintlsources	0.01310226	0.37761524
discussintlcurrentevents	-0.00035617	0.65484709

reliabilitysource	0.10138355	0.47793446
analyzemultiplepov	0.12742474	0.4844676
primarysources	0.13476245	0.43375151
shareculture	0.15847986	0.32927746
virtualinterviews	-0.05082891	0.29154826
synchtech	-0.06101848	0.35515459
asynchtech	0.02602313	0.33710741
standardsalignedpbiglobal	0.15702241	0.41963573
repertoireresources	0.26477197	0.48988734
valuesdiversity	0.27244531	0.27148595
promotesequality	0.28749737	0.21397214
inventoryofcultures	0.24021526	0.24152165
examineotherposs	0.21872821	0.413001
examinetheirculture	0.21806551	0.39345714
risk	0.29074611	0.17225205
voice	0.2526549	0.2161697
analyzeagenda	-0.0548639	0.44386423
iaminformedintlsources	0.08335708	0.49895157
artifacts	0.23126373	0.31325331
breakdownstereotypes	0.11947507	0.31676974
	convosstudentsandcountries	convosaboutconnections
convosstudentsandcountries	1	
convosaboutconnections	0.65261657	1
crossculturalcommunication	0.30560507	0.37461716
providemoretwopov	0.37567393	0.46365065
bringspeakers	0.31822267	0.30599435
intlfieldtrips	0.28439071	0.26774401
assessgl	0.34521561	0.41055281
readintlsources	0.17815827	0.33001921
discussintlcurrentevents	0.24941929	0.38135201
reliabilitysource	0.16927716	0.27357141
analyzemultiplepov	0.20263399	0.30609173
primarysources	0.17428301	0.25950343
shareculture	0.31450706	0.36872467
virtualinterviews	0.39646073	0.30352648
synchtech	0.40200897	0.31276203
asynchtech	0.45163287	0.32651596
standardsalignedpbiglobal	0.22463812	0.38561514
repertoireresources	0.43139472	0.37673702
valuesdiversity	0.17042823	0.24153785
promotesequality	0.03733719	0.15922325

inventoryofcultures	0.13733611	0.29334847
examineotherposs	0.0864577	0.27568639
examinetheirculture	0.29186102	0.3389245
risk	0.05261723	0.11227839
voice	0.08537724	0.14661962
analyzeagenda	0.12094876	0.14260697
iaminformedintlsources	0.22647932	0.30404541
artifacts	0.29869834	0.31565367
breakdownstereotypes	0.13118811	0.29614547
	crossculturalcommunication	providemoretwopov
crossculturalcommunication	1	1
providemoretwopov	0.59062081	1
bringspeakers	0.31279869	0.42097229
intlfieldtrips	0.34046465	0.4250285
assessgl	0.56672127	0.5940833
readintlsources	0.24205204	0.32785768
discussintlcurrentevents	0.29402194	0.59431698
reliabilitysource	0.27175429	0.45443995
analyzemultiplepov	0.28243358	0.50900306
primarysources	0.33679034	0.42793195
shareculture	0.50213359	0.50944604
virtualinterviews	0.21834663	0.31801566
synchtech	0.25428273	0.38288322
asynchtech	0.26506254	0.3905181
standardsalignedpbiglobal	0.35162751	0.42282981
repertoireresources	0.46300292	0.52222412
valuesdiversity	0.2748446	0.29327218
promotesequality	0.18128373	0.25138838
inventoryofcultures	0.30183916	0.31002015
examineotherposs	0.31984338	0.42959088
examinetheirculture	0.33838971	0.45763828
risk	0.07174299	0.12925262
voice	0.12816307	0.23908162
analyzeagenda	0.21728866	0.46100852
iaminformedintlsources	0.34783285	0.46406809
artifacts	0.30203849	0.33123663
breakdownstereotypes	0.24033593	0.31591269
	bringspeakers	intlfieldtrips
bringspeakers	1	1
intlfieldtrips	0.5418817	1



assessgl	0.33425322	0.3450099
readintlsources	0.18066327	0.14211242
discussintlcurrentevents	0.27868454	0.3582369
reliabilitysource	0.21742938	0.31439211
analyzemultiplepov	0.26312098	0.26151376
primarysources	0.29106205	0.24500039
shareculture	0.33908449	0.22694837
virtualinterviews	0.3732182	0.35942314
synchtech	0.37021403	0.45189856
asynchtech	0.34498676	0.45817864
standardsalignedpbiglobal	0.32462943	0.28839595
repertoireresources	0.4010443	0.33749243
valuesdiversity	0.14174985	0.05112422
promotesequality	0.13176893	-0.01851574
inventoryofcultures	0.19025609	0.13316857
examineotherposs	0.22519293	0.15417356
examinetheirculture	0.26901867	0.36577163
risk	0.07509459	0.09925072
voice	0.12363726	0.072028
analyzeagenda	0.27655077	0.27925408
iaminformedintlsources	0.24633509	0.26699381
artifacts	0.3409637	0.22464611
breakdownstereotypes	0.1433822	0.10128906

	assessgl	readintlsources
assessgl	1	
readintlsources	0.29726495	1
discussintlcurrentevents	0.44698305	0.64557802
reliabilitysource	0.34099859	0.48532142
analyzemultiplepov	0.34747214	0.41066849
primarysources	0.42916234	0.45495942
shareculture	0.44038667	0.21867293
virtualinterviews	0.285373	0.19585845
synchtech	0.42556271	0.24531388
asynchtech	0.39825085	0.18894725
standardsalignedpbiglobal	0.48490183	0.26176741
repertoireresources	0.57945735	0.2744322
valuesdiversity	0.17472354	0.26767896
promotesequality	0.14281563	0.23424704
inventoryofcultures	0.22505127	0.079105
examineotherposs	0.28042198	0.18194943
examinetheirculture	0.39984651	0.20460262

risk	0.08983099	0.07132916
voice	0.17681772	0.08252007
analyzeagenda	0.33714711	0.37877963
iaminformedintlsources	0.40890641	0.46773646
artifacts	0.33501176	0.21730265
breakdownstereotypes	0.25597632	0.31069985
	discussintlcurrentevents	reliabilitysource
discussintlcurrentevents	1	
reliabilitysource	0.62515793	1
analyzemultiplepov	0.6217803	0.77214747
primarysources	0.55095955	0.69572111
shareculture	0.2622176	0.22950054
virtualinterviews	0.33431043	0.23503762
synchtech	0.40160547	0.33919367
asynchtech	0.30796773	0.28628395
standardsalignedpbiglobal	0.39274574	0.35205019
repertoireresources	0.3512888	0.27808689
valuesdiversity	0.21868265	0.16163378
promotesequality	0.22257513	0.27719001
inventoryofcultures	0.18665328	0.19513414
examineotherposs	0.37621252	0.35018081
examinetheirculture	0.2994218	0.22233062
risk	0.11876541	0.09269805
voice	0.19518233	0.11568659
analyzeagenda	0.48896483	0.43672806
iaminformedintlsources	0.49092359	0.35896689
artifacts	0.16888537	0.09744181
breakdownstereotypes	0.40701669	0.31181871
	analyzemultiplepov	primarysources
analyzemultiplepov	1	
primarysources	0.71918028	1
shareculture	0.28963694	0.24412335
virtualinterviews	0.23779342	0.25849499
synchtech	0.31827325	0.3388564
asynchtech	0.27467304	0.26760757
standardsalignedpbiglobal	0.35365042	0.43238067
repertoireresources	0.30371426	0.24752465
valuesdiversity	0.23263319	0.11016073
promotesequality	0.29956537	0.17429027
inventoryofcultures	0.21191517	0.165409

examineotherposs	0.43505597	0.33186846
examinetheirculture	0.210489	0.25341964
risk	0.19329816	0.08859792
voice	0.28771817	0.08038834
analyzeagenda	0.40729466	0.44118291
iaminformedintlsources	0.36296181	0.28346458
artifacts	0.10690679	0.1244718
breakdownstereotypes	0.28571544	0.25178463

	shareculture	virtualinterviews
shareculture	1	1
virtualinterviews	0.40923163	1
synchtech	0.41737194	0.77537641
asynchtech	0.36335765	0.67861571
standardsalignedpbiglobal	0.3400871	0.40191219
repertoireresources	0.367638	0.31156659
valuesdiversity	0.39785103	0.0798304
promotesequality	0.2993969	0.12043202
inventoryofcultures	0.4346696	0.070603
examineotherposs	0.29736429	0.15792221
examinetheirculture	0.50052546	0.22614628
risk	0.19739062	0.18839059
voice	0.37223728	0.27122779
analyzeagenda	0.2260632	0.28324044
iaminformedintlsources	0.29802562	0.23420083
artifacts	0.34363322	0.26635004
breakdownstereotypes	0.32957304	0.23109073

	synchtech	asynchtech
synchtech	1	1
asynchtech	0.81508102	1
standardsalignedpbiglobal	0.50806686	0.55631251
repertoireresources	0.37243521	0.44154113
valuesdiversity	0.12579786	0.17547345
promotesequality	0.09901489	0.13600032
inventoryofcultures	0.10331248	0.18429051
examineotherposs	0.16797422	0.19050698
examinetheirculture	0.27662663	0.26506393
risk	0.14482369	0.14419015
voice	0.24387283	0.21032624
analyzeagenda	0.37373266	0.24429504
iaminformedintlsources	0.36574161	0.36277838

artifacts	0.38783989	0.35995099
breakdownstereotypes	0.24785014	0.17766899
	standardsalignedpbiglobal	repertoireresources
standardsalignedpbiglobal	1	1
repertoireresources	0.49762264	0.54062022
valuesdiversity	0.19133235	0.3868806
promotesequality	0.14464736	0.39268979
inventoryofcultures	0.198317	0.41568879
examineotherposs	0.33779587	0.49056224
examinetheirculture	0.30554759	0.2152488
risk	0.14113409	0.30955519
voice	0.14847321	0.29502308
analyzeagenda	0.26840138	0.42291154
iaminformedintlsources	0.35403091	0.46700974
artifacts	0.29889703	0.29445906
breakdownstereotypes	0.33481673	
	valuesdiversity	promotesequality
valuesdiversity	1	1
promotesequality	0.83438679	0.50923694
inventoryofcultures	0.51740389	0.56597001
examineotherposs	0.59626432	0.48489229
examinetheirculture	0.56017288	0.46300633
risk	0.42060771	0.60205819
voice	0.60622474	0.3073617
analyzeagenda	0.18542424	0.39115042
iaminformedintlsources	0.40882954	0.35567431
artifacts	0.41557224	0.49958501
breakdownstereotypes	0.5153244	
	inventoryofcultures	examineotherposs
inventoryofcultures	1	1
examineotherposs	0.53555888	0.58073666
examinetheirculture	0.52567102	0.41762503
risk	0.29793129	0.51951542
voice	0.42254461	0.44362189
analyzeagenda	0.22411522	0.43938141
iaminformedintlsources	0.32960414	0.4062183
artifacts	0.26863869	0.46872059
breakdownstereotypes	0.32574743	

	examinetheirculture	risk
examinetheirculture	1	
risk	0.1769551	1
voice	0.35063482	0.76258423
analyzeagenda	0.32114515	0.21870824
iaminformedintlsources	0.43555747	0.26105844
artifacts	0.49817113	0.26817673
breakdownstereotypes	0.43074225	0.33339333
	voice	analyzeagenda
voice	1	
analyzeagenda	0.35838556	1
iaminformedintlsources	0.26950196	0.46240298
artifacts	0.35553462	0.24619697
breakdownstereotypes	0.42987321	0.33659768
	iaminformedintlsources	artifacts
iaminformedintlsources	1	
artifacts	0.46398923	1
breakdownstereotypes	0.4474981	0.45921755
	breakdownstereotypes	
breakdownstereotypes	1	

Appendix K

**Teaching for Global Readiness Scale**

### Teaching for Global Readiness Scale

**Validity and Reliability:** The Teaching for Global Readiness Scale was developed following extensive validation protocols and rigorous psychometric testing. After defining teaching for global readiness through exploratory qualitative analysis of 24 expert teacher interviews, this scale was developed and administered to K-12 classroom teachers across the US. Based on EFA and CFA results using split-half samples from 630 respondents, teaching for global readiness was interpreted as a multidimensional construct with four factors: *situated practice*, *integrated global learning*, *critical literacy instruction*, and *transactional experiences*. The scale meets recommended validity, reliability, and model fit criteria ( $\chi^2 (143) 246.91$ ,  $\chi^2/df = 1.73$ , CFI = 0.96, TLI = 0.95, SRMR = 0.06, RMSEA = 0.05,  $\alpha = 0.88$ ).

**Purpose:** Global readiness involves teaching students about global issues and preparing them for a global information society. The purpose of this survey is to gain a better understanding of planning and instructional teacher practices that promote students' global readiness.

**Directions:** The following pages contain a number of statements with which some people agree and others disagree. Please rate how much you personally agree or disagree with these statements about what you do as a teacher within a typical semester

During a typical semester . . .

	Strongly Disagree	Disagree	Neither	Agree	Strongly Agree
I build a repertoire of resources related to global education.	<input type="radio"/>	<input type="radio"/>	<input type="radio"/>	<input type="radio"/>	<input type="radio"/>
I take inventory of the cultures (languages, countries, etc.) represented by my students.	<input type="radio"/>	<input type="radio"/>	<input type="radio"/>	<input type="radio"/>	<input type="radio"/>
I cultivate a classroom environment that promotes equality.	<input type="radio"/>	<input type="radio"/>	<input type="radio"/>	<input type="radio"/>	<input type="radio"/>
I cultivate a classroom environment that values diversity.	<input type="radio"/>	<input type="radio"/>	<input type="radio"/>	<input type="radio"/>	<input type="radio"/>
I provide a space that allows learners to take risks.	<input type="radio"/>	<input type="radio"/>	<input type="radio"/>	<input type="radio"/>	<input type="radio"/>
I provide a space that allows students a voice.	<input type="radio"/>	<input type="radio"/>	<input type="radio"/>	<input type="radio"/>	<input type="radio"/>

**Directions:** Below are clusters of questions containing teaching practices. They are designed to investigate the practices that you incorporate as you are teaching global education to promote students' global readiness. Please rate how often you incorporate the practice within a typical semester.

When **teaching for global-readiness** in a typical semester, how often do you...

	Never	Less than once a month	Once a month	2-3 times a month	Once a week	2-3 times a week	Daily
Integrate global learning with the existing curriculum.	<input type="radio"/>	<input type="radio"/>	<input type="radio"/>	<input type="radio"/>	<input type="radio"/>	<input type="radio"/>	<input type="radio"/>
Use inquiry-based lessons about the world (e.g., research projects, exploratory learning, discovery learning).	<input type="radio"/>	<input type="radio"/>	<input type="radio"/>	<input type="radio"/>	<input type="radio"/>	<input type="radio"/>	<input type="radio"/>
Bring in speakers from different backgrounds so that students can listen to different perspectives.	<input type="radio"/>	<input type="radio"/>	<input type="radio"/>	<input type="radio"/>	<input type="radio"/>	<input type="radio"/>	<input type="radio"/>
Attempt to break down students' stereotypes.	<input type="radio"/>	<input type="radio"/>	<input type="radio"/>	<input type="radio"/>	<input type="radio"/>	<input type="radio"/>	<input type="radio"/>
Assess students' global learning.	<input type="radio"/>	<input type="radio"/>	<input type="radio"/>	<input type="radio"/>	<input type="radio"/>	<input type="radio"/>	<input type="radio"/>

During global-readiness instruction in a typical semester, how often do you **ask students to...**

	Never	Less than once a month	Once a month	2-3 times a month	Once a week	2-3 times a week	Daily
Engage in discussions about international current events.	<input type="radio"/>	<input type="radio"/>	<input type="radio"/>	<input type="radio"/>	<input type="radio"/>	<input type="radio"/>	<input type="radio"/>
Analyze the reliability of a source.	<input type="radio"/>	<input type="radio"/>	<input type="radio"/>	<input type="radio"/>	<input type="radio"/>	<input type="radio"/>	<input type="radio"/>
Analyze content from multiple perspectives.	<input type="radio"/>	<input type="radio"/>	<input type="radio"/>	<input type="radio"/>	<input type="radio"/>	<input type="radio"/>	<input type="radio"/>
Analyze the agenda behind media messages.	<input type="radio"/>	<input type="radio"/>	<input type="radio"/>	<input type="radio"/>	<input type="radio"/>	<input type="radio"/>	<input type="radio"/>
Construct claims based on primary sources.	<input type="radio"/>	<input type="radio"/>	<input type="radio"/>	<input type="radio"/>	<input type="radio"/>	<input type="radio"/>	<input type="radio"/>
Utilize asynchronous technology (e.g., email, blogs) for international collaboration.	<input type="radio"/>	<input type="radio"/>	<input type="radio"/>	<input type="radio"/>	<input type="radio"/>	<input type="radio"/>	<input type="radio"/>
Utilize synchronous technology (e.g., Skype, Google Hangout, FaceTime) for international collaboration.	<input type="radio"/>	<input type="radio"/>	<input type="radio"/>	<input type="radio"/>	<input type="radio"/>	<input type="radio"/>	<input type="radio"/>
Utilize technology for virtual interviews (with experts, community members).	<input type="radio"/>	<input type="radio"/>	<input type="radio"/>	<input type="radio"/>	<input type="radio"/>	<input type="radio"/>	<input type="radio"/>