

## A SIMULATION TESTBED FOR INVESTIGATION OF TANDEM AGV SYSTEMS

Leon Bing-Shiun Chuang  
Joseph A. Heim

Industrial Engineering, 352650  
University of Washington  
Seattle, Washington 98195, USA

### ABSTRACT

A tandem, one vehicle per loop, approach to Automated Guided Vehicle System (AGVS) guide path design has been proposed as a more efficient and flexible alternative to traditional AGV system design. The tandem design can substantially simplify the design task while providing even further flexibility for changes in production system layout and operation. Tandem guide paths, however, have potential disadvantages because vehicle break-down, or even scheduled maintenance of vehicles, results in loop inaccessibility.

Previous work comparing the efficacy of traditional guide path configurations and tandem loop configurations provided only limited flexibility for experimentation. A tandem AGV system simulation testbed has been developed to facilitate investigation and analysis of a variety of loop reconfiguration strategies and algorithms. A particular focus of our current investigations is the concept of *Real-Time Loop Reconfiguration* (RTLRL), a means of responding to single vehicle failures in tandem AGV systems. The RTLRL can solve the potential loop inaccessibility problem and also enhance the flexibility of the overall AGV system design.

Results from initial studies used to verify the correct operation of the testbed are presented, and a brief outline of future applications for the tandem loop reconfiguration model are discussed.

### 1 INTRODUCTION

The automated guided vehicle (AGV) has the potential for improving the performance of the material handling tasks required in advanced manufacturing systems. However, good design of the AGV system plays an essential role in using the technology efficiently. The AGV system design effort is comprised of the route configuration, AGV dispatching rules selection, traffic control, and obviously, vehicle selection. In this paper we will

focus on the design of the guide paths rather than the mechanical or electrical components of the systems.

The tandem guide path design approach has been recognized as a more efficient and flexible alternative to traditional guide path design, because it significantly reduces the complexity of the overall AGV system design effort (Bozer and Srinivasan 1991). The tandem AGV system configuration as illustrated in Figure 1, however, does present potential disadvantages: a loop (i.e., one closed segment of the AGV system guide path set) may become inaccessible because the AGV assigned to a single loop is unavailable. The loss of an AGV is usually a result of vehicle break-down or scheduled maintenance. But there are also opportunities to enhance the flexibility of the production system layout with tandem guide paths.

Previous ways of responding to the loss of vehicle-services has been to provide a stand-by AGV. Providing "spare" vehicles, however, can be an expensive way to provide continued material handling services to all loops. And, in some instances, this approach may not be practical, because vehicle configurations may not be consistent across all loops.

To compensate for this potential problem, we have developed what we call *Real-Time Loop Reconfiguration* (RTLRL). RTLRL is a means of responding to the loss of one or more vehicles (i.e., loop accessibility) and a way to dynamically change the control strategies for the AGV system based on product mix or production machinery availability.

The complex nature of AGV system design in this situation provides several opportunities to combine analytical and simulation-based methodologies. In this paper we will report on the simulation aspects of the project. The complex nature of AGV system design in this situation provides several opportunities to combine analytical and simulation-based methodologies. In this paper we will report on the simulation aspects of the project. Discrete event simulation techniques have been frequently used to design and evaluate alternative AGV systems, often

because complex production-based systems become analytically intractable due to the interactions among the many elements of the overall manufacturing system. Simulation models can provide detailed analyses of the dynamic behavior of the system along time, as opposed, analytical approaches are generally limited to examinations of static performance characteristics for the system (Pegden, Shannon and Sadowski 1995). The dynamic aspects of simulation readily supports the types of investigation and analysis of the loop inaccessibility problem and the dynamic behavior of RTLRL during operation of the AGV system.

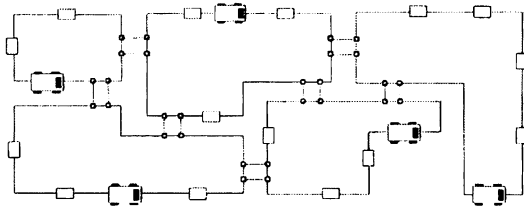

Figure 1: The Tandem AGV System Configuration

## 2 TANDEM AGV SYSTEMS

The tandem AGV system configuration was first proposed by Bozer and Srinivasan in 1991. The intention was to reduce complexity and the attendant difficulties in the traditional AGV system design stage caused by the need to prevent vehicle congestion and blockage when two or more vehicle routes must share the same guide paths; these problems do not exist in the tandem AGV system. Additionally, the AGV system dispatch rules are greatly simplified, since a transport request can only be made to the AGV traveling in the loop from which the request originates. The tandem approach to guide path management strongly supports group technology facility layout techniques: each tandem loop represents a manufacturing cell performing a certain associated series of processes.

### 2.1 Design Rules for Tandem AGV Systems

The tandem AGV configuration is defined as an AGV system in which all stations have been partitioned into non-overlapping, single vehicle closed loops with pick-up/drop-off points interfacing adjacent loops. Therefore, an AGV can travel only

inside the non-overlapped loop to which it is assigned, eliminating vehicle congestion, blockage, deadlock or AGV assignment rules.

The term *loop inaccessibility* as used here means a tandem AGV loop that can not be reached because the AGV residing in this loop is unavailable. Unavailability of the AGV could be because of maintenance requirements (e.g., battery recharging), AGV breakdown, or the desire to add another loop (i.e., workcell to the guide path configuration set). Note that loop inaccessibility means that the machinery, equipment, tools, materials and work pieces in progress within the manufacturing cell cannot be reached; all the machines in that loop may still be functioning.

### 2.2 Real Time Loop Reconfiguration

The RTLRL strategy is to pre-define alternative, overlapped reconfiguration guide paths which connect two adjacent loops. These reconfigurations allow the AGV in an adjacent loop to travel across to the inaccessible loop when necessary, thus making the inaccessible loop reachable once again. Naturally, we would expect that such reconfigurations or combining of loops will increase the utilization of the "borrowed," adjacent-loop AGV.

Rules for determining which adjacent loops should be reconfigured to provide transport services to the inaccessible loop is another aspect of this research which is being examined analytically; it will not be discussed in this paper. In the simulation testbed presented here, our rule for reconfiguration is to always use the shortest adjacent loop, therefore, as shown in Figure 2, inaccessible Loop-3 is always reconfigured with Loop-1 as Loop-3/1, likewise, inaccessible Loop-5 is always reconfigured with Loop-4 as Loop-5/4.

## 3 THE CONCEPTUAL MODEL AND SIMULATION MODELING

Following the traditional simulation project steps (Law and Kelton 1991), this study was conducted first by identifying the problems of interest, constructing and understanding the conceptual model and then building the simulation model using an appropriate computer programming language. In the following sections, several of these steps are explained in detail.

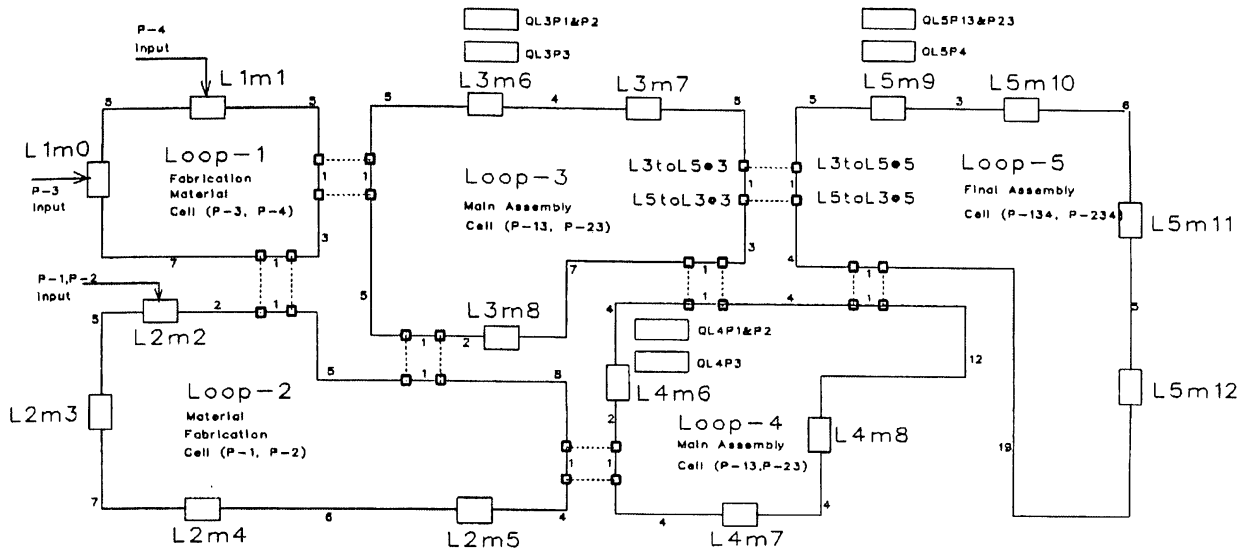

Figure 2: The Production System Layout of the Simulation Testbed

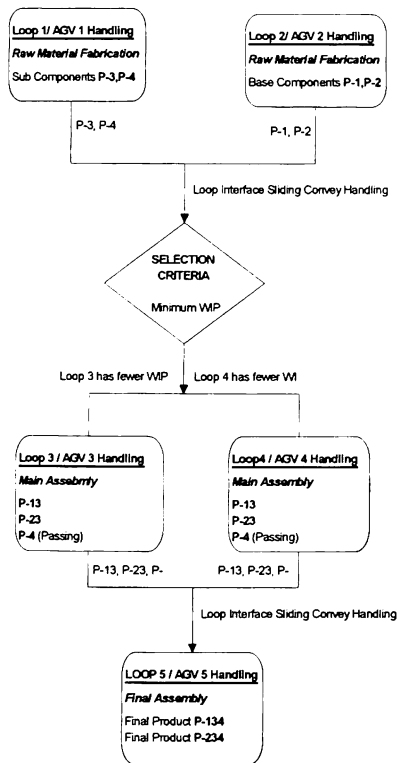

Figure 3: The Processes Followed to Make the Two Final Products, P-134 and P-234

### 3.1 Problem Statement and Planning

The objective of the initial study undertaken with the testbed was to characterize the impact on the performance of the system when a loop became inaccessible. We wanted to evaluate the effect of RTL: could it minimize the loss caused by loop inaccessibility? Since this is the first introduction of RTL, we also want to provide justification for using it in a tandem AGVS design and thus arises some interesting issues for possible future studies.

### 3.2 The Conceptual Model Understanding

The conceptual testbed model presented in this paper is an assembly manufacturing system laid out in a tandem AGV configuration following group technology plant layout guidelines. Figure 2 illustrates the production system layout of the simulation testbed.

Figure 3 explains the processes followed to make the two final products, P-134 and P-234. Two base components, P-1 and P-2, and two sub-components, P-3 and P-4, are sent to the *material fabrication* processes. P-1 and P-2 are then assembled with P-3 in the *main assembly* process; these two intermediate products, called P-13 and P-23, are then assembled with P-4 in the final assembly process, and the final products, P-134 and P-234, leave the system. Each end product is composed of one base component P-1 or P-2, and two sub-components P-3 and P-4.

Material handling requests between machines within each tandem loop (i.e., manufacturing cell) are

performed by the AGV assigned to the loop. Moreover, the material handling between loops is assumed to be performed by a sliding conveyor.

Fabricated components choose the main assembly loop -- Loop-3 or Loop-4 -- which has least work-in-process (WIP). Obviously, more comprehensive rules could be adopted for loop selection. See section 5.4 for further discussions.

### 3.3 Verification and Validation

Verification and validation are the two important parts for simulation modeling. Verification insures that the simulation model behaves as it was programmed to behave, and validation is necessary to convince we that the model properly represents reality.

We have verified our simulation program by exhaustively tracing entities through the system and examining, quantitatively, the flow time, waiting time and traveling time. Our results have given us confidence that the components follow the right assembly sequences from material fabrication through final assembly, and that the values obtained are what one would expect based on hand calculations. Animation has also been a useful auxiliary tool for visual verification of proper model operation.

Validation is more difficult because the relatively small systems we have constructed thus far would not justify AGVs in an actual production situation. The manufacturing assembly system we have developed, however, does reflect appropriate magnitudes: the dimensions of the production floor and loops, the vehicle traveling speed (100 ft/min.), production machinery operation times, and the handling time (30 seconds for AGVs) all conform with common industrial specifications.

## 4 EXPERIMENT DESIGNS

In order to observe the impact of the loop inaccessibility, as well as to justify to what extent the implementation of RTLRL can compensate for the loop inaccessibility, a total nine experiments are conducted in three categories as listed below:

### I. Normal Operation

- E1. System operating with no AGV or machine breakdown.

### II. Loop Inaccessibility

- E2. Non-critical Loop-3 inaccessibility with periodic maintenance for AGV-3.

- E3. Critical Loop-5 inaccessibility with periodic maintenance for AGV-5.

- E4. Non-critical Loop-3 inaccessibility with unpredictable AGV-3 breakdown.

- E5. Critical Loop-5 inaccessibility with unpredictable AGV-5 breakdown.

### III. Real Time Loop Reconfiguration (RTLRL)

- E6. RTLRL implementation of Loop-3/1 corresponding to E2.

- E7. RTLRL implementation of Loop-5/4 corresponding to E3.

- E8. RTLRL implementation of Loop-3/1 corresponding to E4.

- E9. RTLRL implementation of Loop-5/4 corresponding to E5.

In the normal operation scenario, all AGVs are traveling in good condition at a constant speed of 100 feet/minute (fpm). The *critical loop* is defined as a loop that is unique to the system, and its loop inaccessibility will cause the system operation to fail immediately (i.e., the material fabrication loops and the final assembly loop in the testbed).

In contrast, a non-critical loop contains functions that are duplicated in another loop and, therefore, its loss will not stop the entire system. A main assembly loop in the testbed would be considered non-critical because there are two of them. The AGV maintenance schedule for all experiments is 400 minutes after 4000 minutes of operation. During AGV maintenance, the loop is inaccessible. A stochastic AGV break-down occurs once in each experiment and cause the loop to be inaccessible for 1440 minutes (24 hours).

## 5 ANALYSIS OF SIMULATION RESULTS

In order to evaluate the differences in system performance between experiments, three kinds of manufacturing measurement factors are used. The product associated metrics, the system associated metrics and the resource associated metrics.

The product metrics include product flowtime through the system, product waiting time for AGVs, product waiting time for machines, and the ratio of material handling time (including all time spent in waiting and material handling) to machine processing time. These are based on final products. For example, the product flowtime of P-134 is measured as the time interval between the input of base component P-1 and the output of the final product P-134.

System metrics include the throughput of the assembling system during a specific time period (in

this study, 24,000 minutes with the first 2,000 minutes as warm-up period is simulated for all experiments), and the maximum quantity of work-in-process (WIP) of the actual products in system. We consider WIP to be the number of products in a manufacturing cell waiting for either AGV handling or machines processing. It's possible that the simulation model may generate more WIP than the physical capacity would permit; we ignore these constraints. The resource metrics used here include the AGV and the maximum machine utilization of each loop, which are estimated as the time a resource (either an AGV or a machine) is on duty over the total time stimulated.

The metrics were collected after the system performance had achieved steady state, so that the statistical bias of the warming-up period could be minimized.

### 5.1 Negative Impact of Loop Inaccessibility

Examining Table 1, you can see that the four product associated measurement factors, the product flowtime, the waiting time for AGVs, the time waiting for machines and the ratio of handling time to processes time, all increase when loop inaccessibility occurs. As expected, inaccessibility of the critical loop has more serious negative impact on performance than the non-critical loop in terms of these factors. The worst situation happens when the critical loop is not accessible with unpredictable AGV break-down which is 2.6 times of that in normal operation.

Table 1: Product Associated Measurement Factors

		Product Flowtime (minutes)	Waiting AGVs (minutes)	Waiting Machines (minutes)	Handling/ Processing (%)
I	E1	245.49	23.96	33.17	31.16
II	E2	301.45	29.33	88.83	43.94
	E3	334.23	45.16	100.79	49.44
	E4	398.68	29.02	181.38	57.61
	E5	646.78	98.25	360.25	73.87
III	E6	245.38	46.03	32.66	31.13
	E7	245.57	51.17	32.99	31.74
	E8	244.75	47.00	31.94	30.95
	E9	250.86	54.89	32.22	32.63

Figure 4 shows the product flowtime for Experiment 1 (E1), normal operation. Figures 5

through 8 illustrate the dynamic behavior of the system in terms of product flowtime measurement for the four loop inaccessibility experiments, E2, E3, E4 and E5. It is evident by examining Figures 5 and 7, that when there is inaccessibility to non-critical loop resources, the system can still yield continuous output. And also interesting to note are the two sets of product flowtime measurement output when the non-critical loop becomes inaccessible: one for those products blocked and delayed by the inaccessible non-critical loop (Loop 3), and one for those going through the other loop performing the same manufacturing activity as the inaccessible non-critical loop. However, in contrast, Figures 6 and 8 illustrate the consequences of critical loop failure. A discontinuous output is generated with an output gap equal to the length of loop inaccessibility; all the products are affected by loss of the critical loop.

Table 2 provides a list of system associated measurement factors, the throughput of the simulated assembly manufacturing testbed during a 24,000-minute period, and the maximum number of WIP for each tandem AGV loop/manufacturing cell recorded along simulation run. As mentioned previously, the output gap is caused by critical loop failure and results are a loss in terms of throughput for the tandem AGV system. In Experiment 5 (E5) the size of work in process becomes completely unacceptable: 221, as compared to 13 during normal operation.

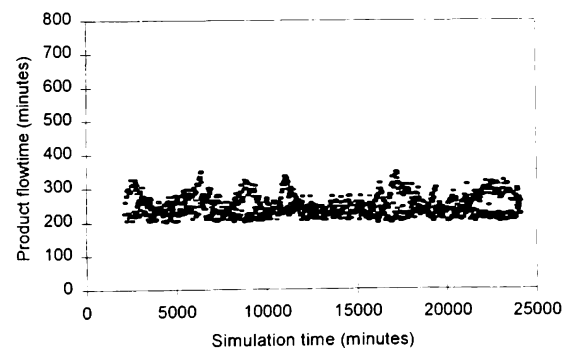

Figure 4: Product Flowtime of E1

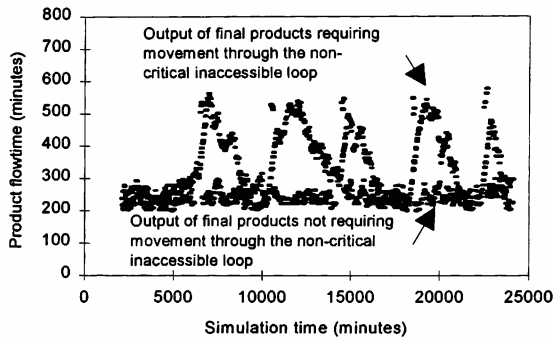

Figure 5: Product Flowtime of E2

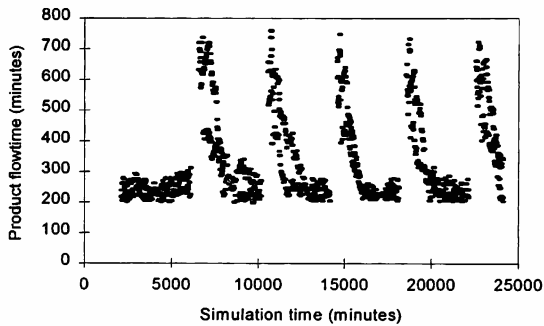

Figure 6: Product Flowtime of E3

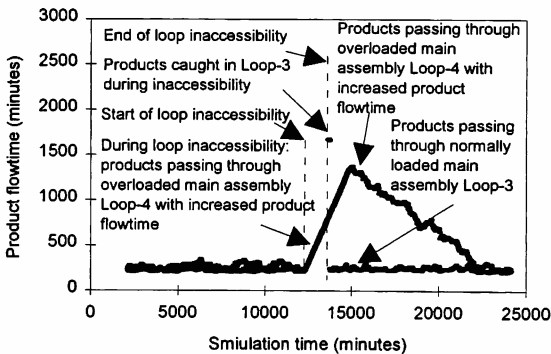

Figure 7: Product Flowtime of E4

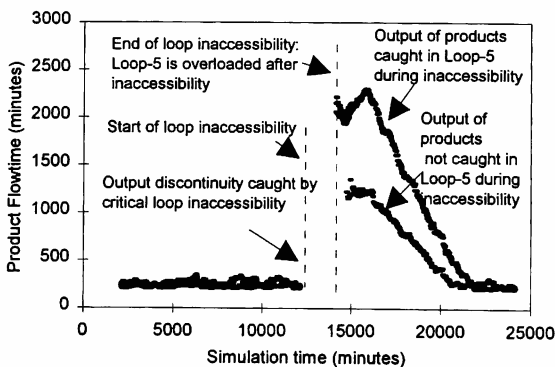

Figure 8: Product Flowtime of E5

Table 2: System Associated Measurement Factors

		Throughput		Maximum WIP Recorded				
		22,000 Minutes		L1	L2	L3	L4	L5
I	E1	1223		1	7	12	13	9
II	E2	1219		1	6	12	23	9
	E3	1205		1	6	12	19	60
	E4	1204		1	7	12	61	9
	E5	1185		1	7	11	60	221
III	E6	1221		2	6	11	13	9
	E7	1224		1	7	13	12	14
	E8	1221		2	7	12	13	9
	E9	1223		1	7	12	17	15

The AGV utilization factor not only provides information about system balance during the design stage, but it can also help determine the appropriate number of vehicles necessary under varying conditions. In Table 3, AGV utilization among experiments seems to be only minimally influenced by loop inaccessibility. This implies a design with less loading can return to steady state without creating bottlenecks in the system due to overloaded AGVs.

Table 3: Resource Associated Measurement Factors

		AGV Utilization				
		L1	L2	L3	L4	L5
I	E1	28.97	54.62	71.43	32.26	60.89
		55.56	72.51	91.79	86.66	78.39
II	E2	29.11	56.68	66.18	36.99	61.18
		55.56	72.69	83.69	95.04	78.70
	E3	29.11	56.47	66.92	36.13	60.77
		55.56	72.36	85.89	91.96	78.04
E4	29.10	56.40	66.80	36.15	61.19	
	55.56	72.48	85.22	93.20	78.42	
III	E5	29.09	56.38	67.13	36.18	60.80
		55.56	72.46	85.61	92.65	78.37
E6	32.99	55.28	66.66	33.38	60.93	
	55.56	72.66	90.36	88.29	78.65	
E7	28.95	54.30	71.84	36.95	57.01	
	55.56	72.50	91.57	86.67	78.27	
E8	32.76	55.56	66.67	33.29	60.88	
	55.56	72.64	90.85	87.84	78.65	
E9	28.95	54.58	71.37	37.35	57.12	
	55.56	72.65	90.31	88.40	78.70	

## 5.2 Compensating Effects of Implementing RTL R during Loop Inaccessibility

The results of the simulation experiments illustrate that implementing RTL R provides a compensating effect for the loss of a single loop guide path. From Tables 1, 2 and 3, the metrics reflect no significant differences from those recorded in normal operation. Even for the critical loop inaccessibility situation, real time loop reconfiguration can make the system behave as if the system were under normal operation. Figures 9 through 12 show this in terms of product flowtime. Although the measurements of product waiting time for AGVs in E6, E7, E8 and E9 rise to an amount from 1.9 to 2.3 times of that in normal operation, the overall performance measurement in terms of product flowtime and the ratio of handling time to machine process time performs almost as well as it was in normal operation.

## 5.3 Factors Essentially Affecting Loop Inaccessibility

From observing the simulation generated results, one can find some important factors that essentially affect the impact of loop inaccessibility. In general, we can infer from the simulation results that the non-critical loop inaccessibility will cause congestion, and that the critical loop inaccessibility will cause an additional problem of discontinuity in processing flow. The time interval of the loop inaccessibility plays a more influential role in affecting the extent of the impact far more than the frequency of the loop inaccessibility.

## 5.4 Future Studies

Initial tests with relatively simple RTL R situations have been presented in this paper. There are, however, more complex and interesting issues for which further studies will help us understand when RTL R may be most appropriately applied as well as which strategies for loop reconfiguration are most likely to enhance the tandem AGV system flexibility. Some of these include:

1. RTL R can be used to help partition the manufacturing floor during the early stages of the production system design by examining the consequences of pre-defining "spare" guide paths for production system reconfiguration (i.e., redefining manufacturing workcells). In this way, a tandem AGV system with RTL R capability can reduce cost

associated with an over partitioned floor (Harit 1995).

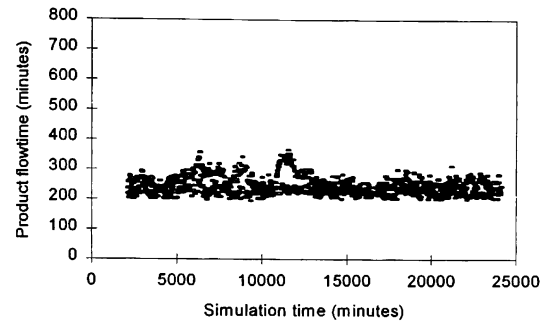

Figure 9: Product Flowtime of E6

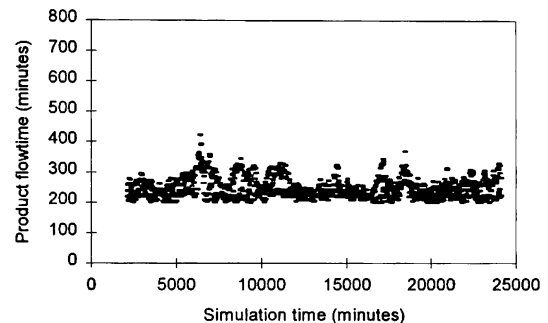

Figure 10: Product Flowtime of E7

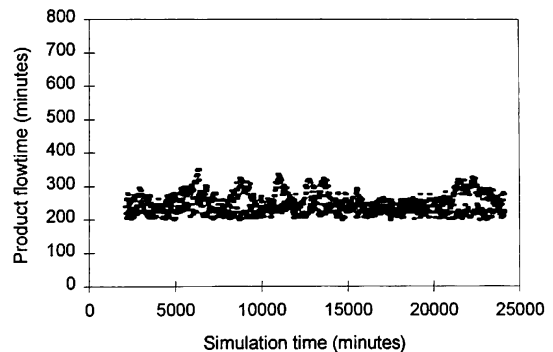

Figure 11: Product Flowtime of E8

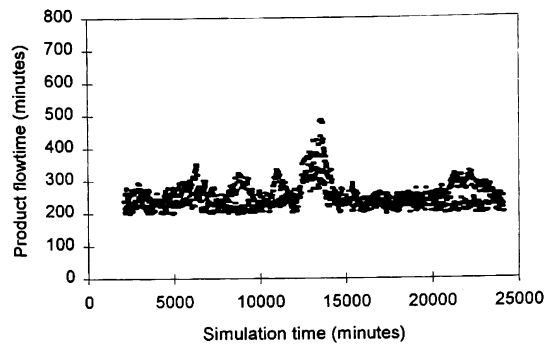

Figure 12: Product Flowtime of E9

2. In this paper, the “shortest AGV traveling guide path” rule is applied to select from among available adjacent loops (for example, while non-critical Loop 3 is inaccessible, Loop 1 which has the shortest guide path is selected among adjacent Loop 2, 4 and 5). But it is likely that many tandem systems would have more than two adjacent loops, and, because implementing RTLRL will directly increase the material handling loads in the reconfigured loops, rules for selecting from among the adjacent loops should be developed to optimize the reconfiguration.

3. We have examined the results of scheduled maintenance in which vehicles are unavailable. It would be helpful to integrate RTLRL and the creation of AGV maintenance schedules, thus reducing the impact on production output during required maintenance periods. The simulation testbed can provide an efficient mechanism for providing alternative solutions of efficient integration of vehicle maintenance schedule and RTLRL.

4. RTLRL can be used to dynamically (on-line) partition the manufacturing floor into independent AGV transport loops during system operation in response to actual resource utilization. By examining the consequences of various system reconfigurations with an embedded simulation model, a tandem AGV floor with RTLRL capability could be reconfigured flexibly and dynamically to minimize resource idleness and maximize system performance.

## 6 CONCLUSIONS

AGV systems have been studied for many years to improve their capability and enhance their flexibility by providing better overall designs. We have demonstrated the use of simulation to support the application of Real-Time Loop Reconfiguration (RTLRL) in tandem AGV system design; the results generated by the models indicate that RTLRL can effectively compensate for loop inaccessibility in

tandem loop guide paths. Furthermore, RTLRL can be used to enhance the flexibility of tandem AGV systems by supporting the design of dynamically changing production process flows with pre-partitioned guide path alternatives.

## REFERENCES

- Bozer, Y. A. and M. M. Srinivasan. 1991. “Tandem Configurations for Automated Guided Vehicle Systems Analysis”. *IIE Transaction* 23:1, p71-p82.
- Bozer, Y. A. and M. M. Srinivasan. 1992. “Tandem AGV Systems: A Partitioning Algorithm and Performance Comparison with Conventional AGV Systems”. *European Journal of Operations Research*, 63, p173-p191.
- Choi, H., H. Jin and J. Lee. “Traditional and Tandem AGV System Layout: A Simulation Study”. *Simulation* 63:2, p85-p93, 1994.
- Harit, S. 1995. “Partitioning Algorithm for Multiple Server Tandem Loop Configuration”. Ph.D. dissertation, Department of Industrial Engineering, University of Arkansas.
- Law, A. M. and W. D. Kelton. 1991. *Simulation Modeling and Analysis*, 2nd Ed, New York: McGraw-Hill.
- Pegden, C. D., R. E. Shannon and R. P. Sadowski. 1995, *Introduction to Simulation Using SIMAN*. 2nd Ed. New York: McGraw-Hill.

## AUTHOR BIOGRAPHIES

**LEON BING-SHIUN CHUANG** received his Masters degree from the Department of Industrial Engineering at the University of Washington in 1996. In 1992 Mr. Chuang received his Bachelor of Engineering in Aeronautical Engineering at the Tamkang University in Taipei, Taiwan. His research interest is manufacturing applications of simulation modeling.

**JOSEPH A. HEIM** is an assistant professor of Industrial Engineering at the University of Washington in Seattle, Washington. His teaching responsibilities include computer integrated systems, simulation, inventory management and scheduling. Heim’s research focuses on coordination of complex collaborative tasks with distributed discrete event simulation models. Professor Heim is a member of ASEE, ACM, IIE and SME.