



## Seismic Risk Reduction in Italy Through Innovative Techniques: 2 - R & D on Passive Energy Dissipation Systems

Alberto Dusi<sup>1)</sup>, Massimo Forni<sup>2)</sup>, Alessandro Martelli<sup>2)</sup>, Gabriella M. Castellano<sup>3)</sup> and  
Agostino Marioni<sup>4)</sup>

1) *ENEL-Ricerca & GLIS, Italy*

2) *ENEA & GLIS, Italy*

3) *FIP Industriale & GLIS, Italy*

4) *ALGA & GLIS, Italy*

**ABSTRACT:** Presented in this paper are the most recent studies performed in Italy on innovative anti-seismic techniques of civil and industrial structures (including nuclear plants), in the framework of an ongoing project, partly funded by the European Commission (EC). More precisely, after summarising the general objectives, programmes and achievements of such a project (REEDS), this paper deals with the main features and results of detailed numerical analyses carried out for viscous, viscoelastic and elastic-plastic energy dissipators, as well as an innovative rolling isolation system and structure mock-ups provided with the aforesaid dissipators. The results of studies performed for different energy dissipation devices, made of shape memory alloys, which are used for enhancing the seismic protection of cultural heritage, were presented at the "Monument-98" International Workshop in 1998.

### INTRODUCTION

Large efforts are going on in Italy on the development, validation and application of seismic isolation (SI) and passive energy dissipation (ED) for civil and industrial structures [1-3]. The ongoing R&D activities are being performed in framework of both national collaborations among the members of the Italian Working Group on Seismic Isolation (GLIS), and international co-operative projects between GLIS members and other European and non-European partners.

In 1996 R&D began in Italy in the framework of the three years REEDS project [4], funded by the European Commission (EC), for the development of optimised hysteretic, viscous and viscoelastic ED systems, shock transmitters and innovative rolling SI systems. For the aforesaid project, the Italian activities include the development, testing and numerical analysis of the devices, as well as testing and analysis of mock-ups of structures and components provided with such devices (buildings, industrial components, pipeline segments).

In the same year, a second EC-funded project (ISTECH) [5] also began, which concerns the development of shape memory alloy (SMA) devices for improving the stability, in particular seismic protection, of cultural heritage, through numerical analyses and experiments similar to those mentioned above for the REEDS project. This project also includes an application, which is in progress, to the retrofit of a real structure (the bell-tower of St. Giorgio in Trignano Church, St. Martino in Rio, which was severely damaged by the 1996 earthquake that struck Modena and Reggio Emilia Provinces).

This paper summarises the main features and so far achieved results of studies performed by ENEA and ENEL in the framework of the REEDS project. No information is provided on the progress of activities of the ISTECH project, because its main results were very recently presented at an international workshop [6]. In addition, detailed information on the less recent R&D work performed in both projects is available in the proceedings of the International Post-SMiRT Conference Seminar on "Seismic Isolation, Passive Energy Dissipation and Active Control of Seismic Vibrations of Structures", held at Taormina, Italy, on August 25 to 27, 1997 [7]. Finally, updated and more detailed results of the studies described in this paper will be presented at the Post-SMiRT Conference Seminar on "Seismic Isolation, Passive Energy Dissipation and Active Control of Vibrations of Structures", which will be held at Cheju, Korea, the week after that of the main SMiRT Conference.

## THE REEDS PROJECT

The REEDS project [8-10] is presently in progress. Its main objectives are:

- to optimise the design manufacturing and performance of the already mentioned five different types of anti-seismic devices (hysteretic, viscous and viscoelastic dampers, shock transmitters and innovative rolling systems);
- to fabricate prototypes of such devices;
- to evaluate their benefits for the design of safe structures.

The optimisation of the devices for the reduction of seismic risk of important structures (in particular industrial facilities, including high risk plants, such as nuclear reactors) has required activity on the following topics:

- identification of seismically vulnerable structures and equipment;
- evaluation of performance needs for the innovative anti-seismic devices;
- improvement of materials, functional mechanisms, geometry, operational simplicity and life of the devices;
- development of design and manufacturing techniques of the optimised devices;
- testing of suitable mock-ups of structures and equipment;
- experimental analysis;
- numerical analysis of test results;
- detailed numerical analysis of actual structures and equipment to be built or retrofitted by means of the innovative systems.

The first activities focussed on the definition of a set of representative civil structures, electric and chemical systems for which the adoption of the proposed anti-seismic devices could be an efficient way to mitigate seismic risk. As far as electric systems are concerned, one phase of a 420 kV bay of a Gas Insulated Station (GIS) has been selected. A Liquefied Natural Gas (LNG) tank and portions of pipelines connecting the boiler and the turbine of a power plant have been identified as representative chemical and industrial structures. A reinforced concrete (r.c.) structure, designed for a non-seismic area with only reinforced beams and columns was selected as a civil structure; in addition to this, a steel-frame building requiring seismic rehabilitation was identified as a second civil building. Last, an existing cable-stayed bridge, representative of most bridges which are designed for highly seismicity zones, has been chosen to perform trial calculations and examine the feasibility and benefits of introducing anti-seismic devices.

The state of the activities being performed by the Italian partners is described below.

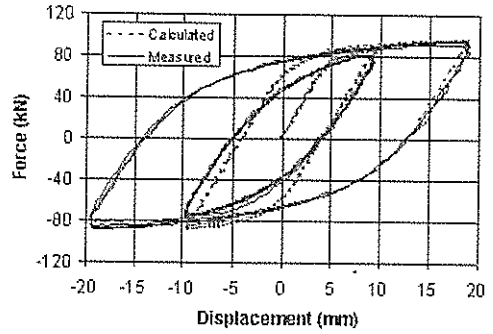
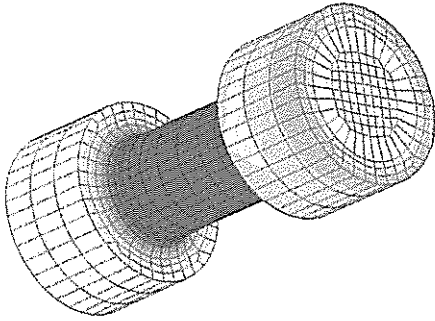

Figure 1a: REEDS Project: FEM of the full-scale elastoplastic torsional device designed for the LNG tank and numerical-experimental comparison.

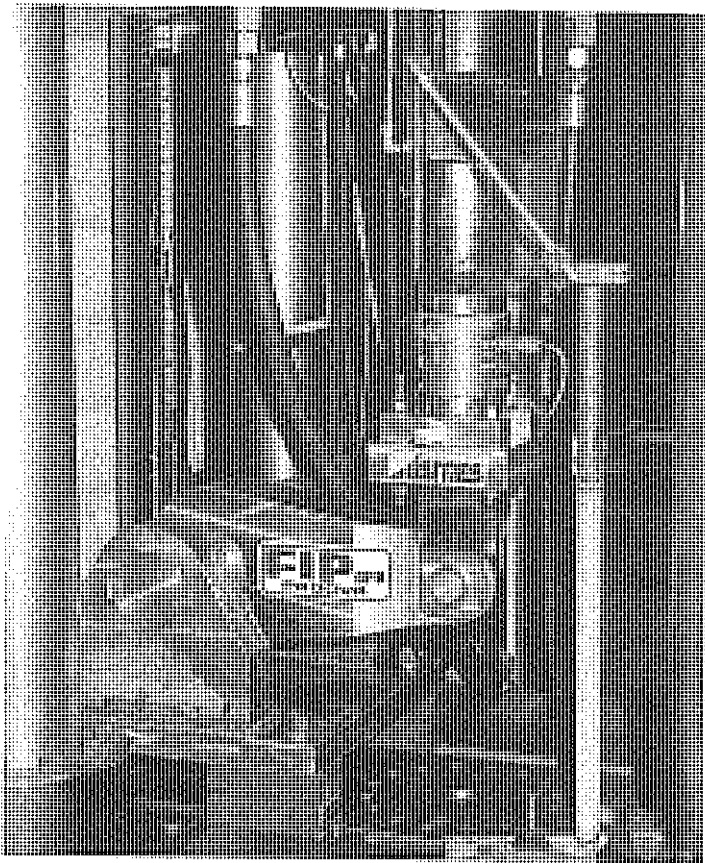

Figure 1b: REEDS Project: Dynamic test on the full-scale elastoplastic torsional device designed for the LNG tank (ISMES laboratories)

## PASSIVE ENERGY DISSIPATION DEVICES

### Elastic-Plastic Devices

An innovative torsional elastic-plastic dissipator (EPD), developed by FIP Industriale, was considered in the REEDS project. Four scaled models of this device were tested by FIP and installed at the base of a scaled mock-up of a seismically isolated LNG tank, which was dynamically tested on shake table at the ENEA Laboratories of Casaccia, Rome (see below). Moreover, two full-scale devices were tested at ISMES Laboratories with different boundary and loading conditions.

Torsional devices have been numerically modelled and analysed by ENEA and ENEL in this study, using the ABAQUS computer program. For the calibration of the elastic-plastic model in ABAQUS, some results of tests performed on an a C-shaped device component (MEP 30-60/160), manufactured and tested by FIP, have been used. This component is made of steel with an elastic-plastic (EP) limit of 300kN and a plastic stroke of 160 mm. The main geometric parameters are: 30 mm thickness, 495 mm length and 95 mm maximum width. It is one of 8 identical components of a two-directional horizontal device. The main feature of this dissipator is a very good three-dimensional (3D) behaviour in the elastic-plastic field; thus, through dissipation, it transmits lower stresses to the supported structures (especially bridges).

After the calibration of the EP model, the torsional device to be used in the shake table tests on LNG tank has been modelled and analysed. In particular, several parametric calculations have been carried out, aimed at defining the best shape and sizes of the device. Fig. 1a shows, as an example, the finite-element model (FEM) of the full-scale devices and the good agreement which was obtained between numerical and experimental results. In particular, this figure refers to a cyclic test with amplitude increasing to failure (Fig. 1b). In this case, to numerically reproduce the initial transient to yielding, it has been necessary to use an isotropic hardening model.

### Viscous Dampers and Viscoelastic Devices

These devices have been developed, within the REEDS project, by ALGA and the British Tun Abdul Razak Research Center (TARRC, former MRPRA), respectively [9, 10]. The viscous dampers (VDs) are oleodynamic actuators provided with an innovative internal oil circuit and filled with oils the viscosity of which is stable in quite a large temperature range (Figs. 2a, b) They will be used on pipelines segments to be tested at the Nuclear Engineering Laboratory (LIN) of the University of Bologna and on a steel-frame mock-up (Model of Isolated Steel Structure, or MISS) which was tested on shake table at the ENEA-Casaccia laboratories (see below). These devices, which were singly tested at ISMES, allow for 10 mm maximum stroke and 100 kN maximum force.

The visco-elastic dampers (VEDs) are simply formed by a single rubber layer (12 mm thick) bonded to two steel plates and working under shear strain (Figs. 3a, b). In the framework of REEDS activities, they will be used in the above-mentioned civil building mock-up to be tested at ELSA laboratory of JRC Ispra (390 mm sides) and were used on MISS (170 mm x 240 mm sides).

No detailed FEMs were developed for VE and VED, but only simplified models to be used in the numerical analyses of the structures (in fact, FEMs are not necessary for such dissipators).

### Rolling Ball Devices

This novel seismic isolation system has been developed by TARRC [11]. Basically, the geometry of the devices consists of metal balls rolling over a rubber-covered metal plate, the

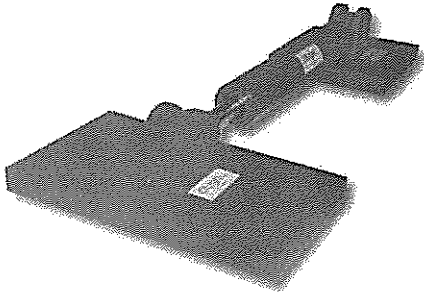

Figure 2a: VD installed on MISS for the shake table tests at ENEA-Casaccia

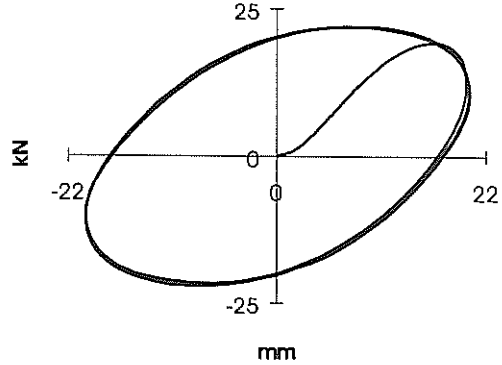

Figure 2b: Hysteresis loops of the VD installed on MISS for the shake table tests

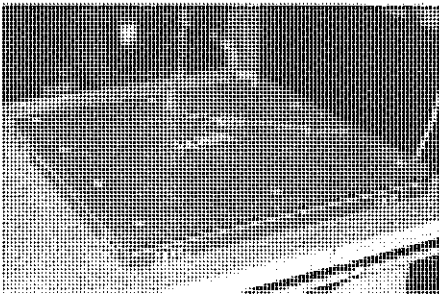

Figure 3a: VED installed on the civil building mock-up (PsD tests at JRC Ispra)

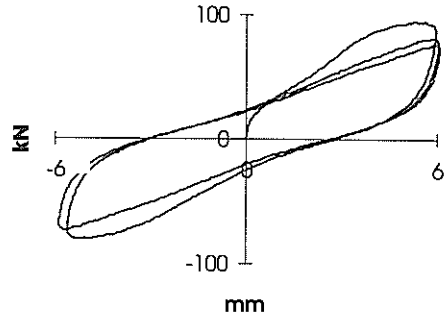

Figure 3b: Hysteresis loops of the VED installed on the civil building mock-up

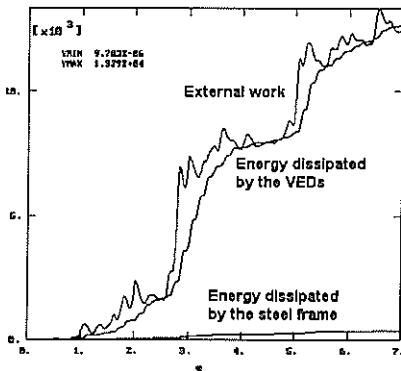

Figure 4a: Energy dissipation of MISS with 4 VED during the application of a synthetic earthquake

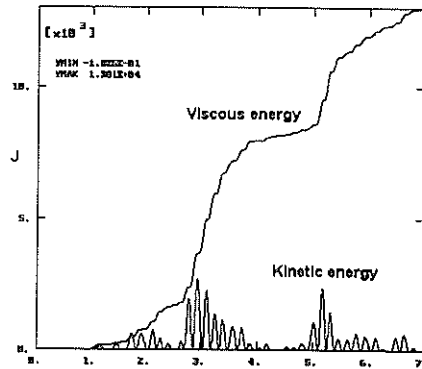

Figure 4b: Energy dissipated by 4 VED on MISS during the application of a synthetic earthquake

rubber being firmly bonded to the metal. The damping can be varied by changing the viscoelastic properties of the rubber and by varying the thickness of the rubber layers. Thus, support and horizontal deflection capabilities are provided by the rolling balls and energy dissipation is provided by the dissipative layers bonded to the rolling tracks. A separate horizontal spring provides the restoring force. The device should be particularly useful for the protection of lightweight structures or individual machines or articles of equipment that may be especially sensitive to seismic damage. As part of the REEDS project, rolling ball isolators and auxiliary horizontal springs are being used for a test mock-up of a high voltage GIS. Characterisation tests have been performed at TARRC on devices similar to those that will be put under the electrical equipment.

## STRUCTURES PROVIDED WITH PASSIVE ENERGY DISSIPATION SYSTEMS

### Features of the MISS Steel Frame Civil Building Mock-up

MISS is a four stories steel structure formed by 6 vertical columns (HE 100 B), 4.5 m high, bolted to a base frame manufactured using HE 140 B beams, which had been manufactured in the framework of a previous EC-funded project, aimed at the optimisation of High Damping Rubber Bearings (HDRBs) [3, 12]. Four horizontal frames (HE 100 B) can be bolted to the columns, with an interstorey distance of 0.9 m or 1.1 m. The total weight of the steel frame is 37 kN. Each horizontal frame, which is 3.3 m x 2.1 m, can support up to 8 r.c. masses, each weighting 12.8 kN (a maximum number of 20 masses is available). The steel used for the fabrication of MISS has an ultimate strength of 430 MPa, a yield strength of 275 MPa and a Young's modulus of 200,000 MPa. Based on experiments, the damping of the steel frame resulted to be 1.7% [2, 7, 10].

The following configurations of MISS (with 0.9 m interstorey distance) had already been tested in previous experimental campaigns: "C1" (no masses and fixed base); "C2" (16 masses, 4 for each floor, fixed base); "C3" (16 masses, 4 for each floor, isolated base).

Configuration "C1" had been subjected to sinusoidal scanning from 0.5 to 35 Hz in order to characterise the steel frame [2, 9, 10]. The fundamental frequencies had resulted to be 1.5 Hz and 2.4 Hz in the longitudinal and transverse directions, respectively. Configurations "C2" and "C3" had been subjected to both vibrational and shake table tests using natural and synthetic 1-, 2- and 3-D earthquake records [2, 9, 10]. Configuration "C2" was tested in the framework of the REEDS project with two different devices, namely, as mentioned above, VDs and VEDs. Processing of test data (which is in progress) will allow for the evaluation of the behavioural differences between using base isolation and energy dissipation techniques.

In order to allow for the insertion of VDs and VEDs, some modifications were made on MISS, with respect to its original lay-out. Two couples of devices will be inserted between the ground and the second floor and between the second and fourth floors. The design requirements for MISS in "C2" configurations are:

- 20 mm maximum allowable displacement at the second floor, to avoid plasticisation of the columns;
- 0.5 g maximum allowable acceleration at the second floor, to avoid overturning of the shake table.

### Numerical Analysis of MISS

A FEM of MISS including simplified models of the VDs and VEDs was implemented in the ABAQUS code. VDs were modelled using non-linear dashpots with a damping coefficient C depending on velocity. VEDs were modelled by coupling in parallel springs and dashpots, where stiffness K and damping coefficient C depend on the frequency of the

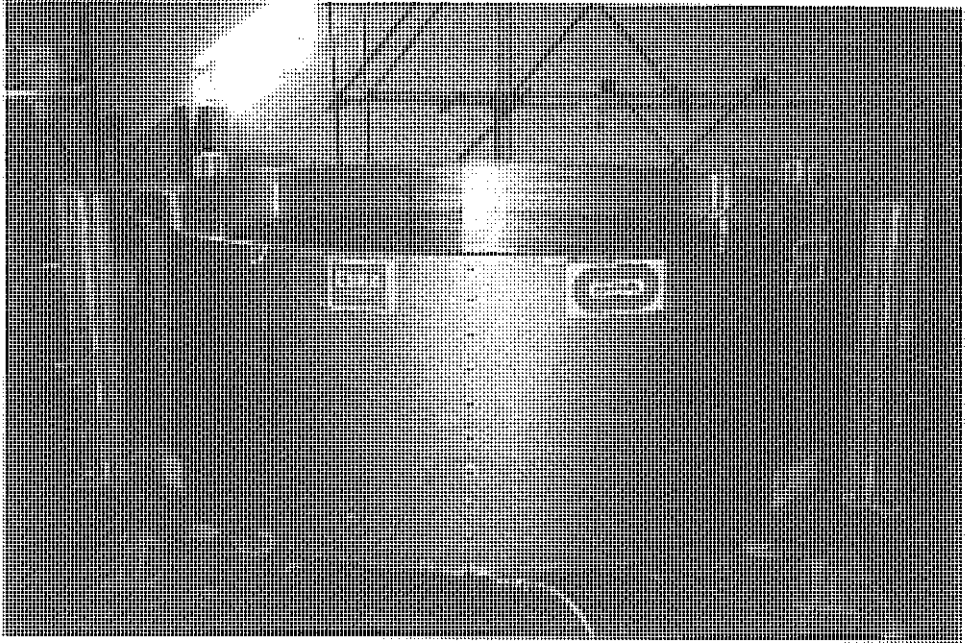

Figure 5a: Mock up of LNG tank tested on shaking table at ENEA laboratories

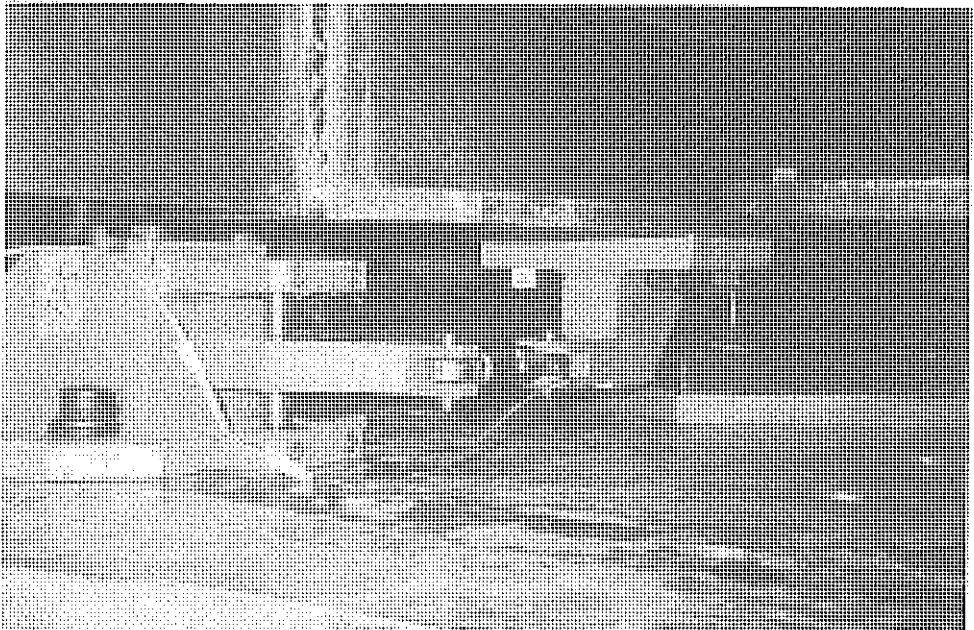

Figure 5b: Torsional elastoplastic device under the LNG tank mock up

structure ( $f$ ), the property of the rubber and the 'Loss Factor' coefficient (LF), as shown by the following correlation (according to TARRC [4], a value of 4 was adopted for LF):

$$C = (LF * K) / 2\pi f. \quad (1)$$

Several calculations were carried out with the aim of defining the best disposition and number of devices to be inserted on MISS and providing input data for the design of the devices and shake table tests. Two synthetic time-histories defined according to Euro-Code 8 (EC8) for soft soils (CGS) and medium soils (BGS) and an actual earthquake (1976 Friuli earthquake recorded at Tolmezzo) were used for the dynamic analyses. The first step of the analyses consisted in the evaluation of the maximum acceleration level that can be withstood by MISS without devices. It was found that the structure can resist with no damage amplifications of 0.9, 1.15 and 0.85 of CGS, BGS and Tolmezzo time-histories, respectively.

The second step of the analysis consisted in the execution of parametric calculations in order to define the stiffness of the devices which leads to the best response of the structure in terms of both deformations and accelerations. Such an analysis showed that a value of 2 kN/mm for the stiffness of VEDs provides the best response of MISS in the case of the CGS time-history with an amplification factor equal to 2. The determination of this value allowed for the final design of the device. The numerical analysis also showed that, in the case of use of four VEDs, MISS can resist the considered earthquakes (CGS, BGS and Tolmezzo time-histories) with amplification factors equal to 2.5, 2.0, 1.9, respectively.

With regard to energy dissipation, the analyses showed that the amount of energy dissipated by the steel frame is negligible with respect to that dissipated by the VEDs, which is practically equal to the external work and very high with respect to the structure kinetic energy (Figs. 4a, b). This demonstrates the adequacy and effectiveness of the devices, which are particularly suitable for installation in flexible structures with large displacements and low internal damping, such as steel frames.

#### Experimental Campaigns on the LNG Tank Mock-Up and MISS

The LNG tank mock-up using the aforesaid torsional EP devices was tested in October 1998 (Figs. 5a, b), while shake table tests on MISS were completed in December 1998 at the ENEA laboratories of Casaccia (Figs. 6a, b). Both experimental campaigns consisted in random and seismic excitation tests, at first without the devices, then with four EPDs (LNG tank) and with four VDs or VEDs (MISS). All structures considered showed a good behaviour in the configurations with energy dissipators, which allowed for the application of base accelerations even twice with respect to those applied in absence of the devices. The detailed analysis of the results of these tests is in progress.

#### Features and Numerical and Experimental Analyses of GIS

Many recent seismic events have clearly indicated that, without appropriate precautions, a major earthquake may damage important parts of the electric transmission and distribution networks. Such inadequate seismic behaviour negatively influences all other lifelines utilities in the emergency situation following an earthquake disaster, when the availability of electric energy is very important also for rescue operations.

An electric power GIS has been selected as representative electric component to be studied in the REEDS project (Fig. 7a). As a matter of facts, due to their strategic position in power networks, substations are essential for the correct operation of electric network: if a fault occurs, consequences can be serious or even disastrous for end users (hospitals, industries, etc). Furthermore, GIS are particularly attractive because of their reduced dimensions, climatic and pollution withstand, safety and high overall reliability (see below).



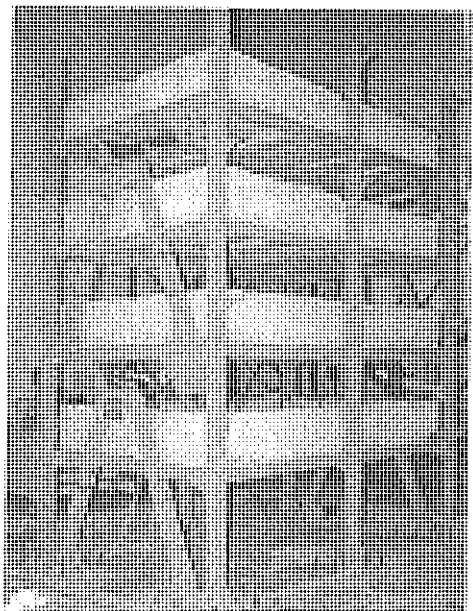

Figure 6a: Tests on MISS with 4 VD at ENEA laboratories

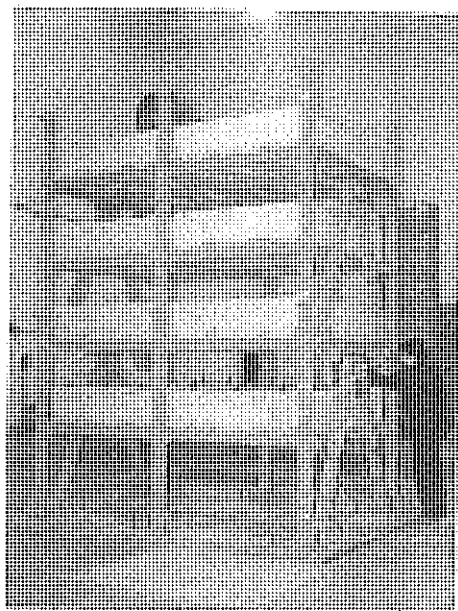

Figure 6b: Tests on MISS with 4 VED at ENEA laboratories

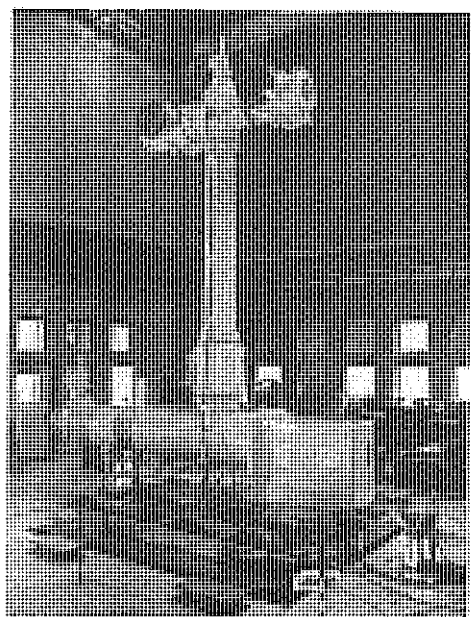

Figure 7a: Tests on GIS with 4 rolling balls at ISMES laboratories

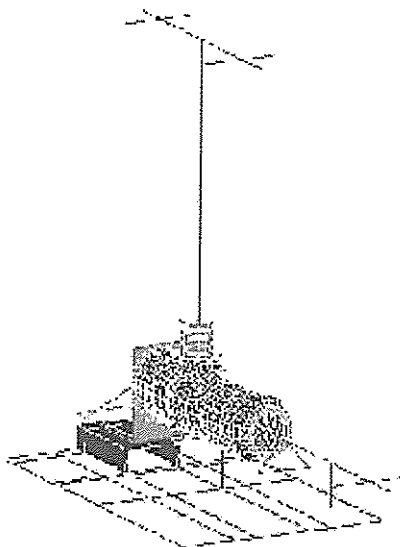

Figure 7b: FEM of MISS implemented by ENEL in the ABAQUS code

A GIS consists in an assembly of prefabricated modular components, where the electric ducts of the main circuit are completely contained within earthed metal enclosures, insulation being provided by a pressurised gas. Circuit breakers, disconnectors, instrument measurement transformers are connected by means of busbars. The substation's architecture is designed to transmit power from one or several sources to one or more feeders; this leads to the creation of basic substation layouts organised around a standard bay which are repeated so as to be coincident with the number of feeders and sources; the bays are then connected by means of busbars.

One single phase of one bay of a 420 kV GIS substation manufactured by GA Alsthom T&D (GA) has been considered in the research activities [9, 10] and was tested on ISMES shake table on June 1998.

Numerical analyses of the GIS portion were carried out by GA and ENEL (Fig. 7b) with the aim of defining a suitable device able to reduce seismic stresses acting on the substation (thus allowing for a required spectrum level either to reduce the frames and civil works or to satisfy higher spectrum levels by conserving standard architecture), by comparing different solutions and providing support in both the design of the devices and definition of the experimental campaign. The TARRC rolling ball system was selected as a suitable solution for this kind of structure. The requirements for such a devices are as follows:

- 1200 kN/m total stiffness for one bay;
- 100 kN/m stiffness of a single device (under the hypothesis of inserting 12 devices / bay or 4 devices/phase);
- $\pm 83$  mm maximum allowable displacement due to the seismic excitation;
- $\pm 40$  mm maximum allowable displacement due to temperature variation (1000 cycles);
- 20% critical damping ratio;
- 400 mm maximum device length, 200 mm maximum width, 200 mm maximum height.

The mock-up tested on shaking table had a mass of 6400 kg (including the base frame put under the GIS phase and the additional masses at the top of the mock-up), while the total required stiffness was 400 kN for the tested phase.

Finite Element (FE) calculations were performed by using ANSYS (GA) and ABAQUS (ENEL), considering different models as well as different discretisations. The mechanical behaviour of the fully constrained substation (i.e. without anti-seismic devices) was first numerically analysed: modal analyses, evaluation of natural frequencies and mass participation factors, spectrum and time-history analyses were carried out in order to evaluate the dynamic behaviour of the structure and assess stress distribution. Subsequently, a second set of FE calculations was performed taking into account the insertion of the anti-seismic devices. Several calculations were performed with the aim of defining the best disposition and number of devices to be put under the GIS phase and providing input data for their design and shake table tests. In all above-mentioned analyses, seismic excitation was defined according to International Electrotechnical Commission (IEC) Standard n° 1166, considering three different excitations (corresponding namely to AF2, AF3 and AF5 seismic qualification levels).

## CONCLUSIONS

The numerical analyses performed by ENEA and ENEL, which have been described in this paper, led to the following general conclusions:

- The FEMs developed for the elastic-plastic dissipators in the REEDS project are very reliable. Thus, they can be used for design and qualification purposes. This result is similar to that obtained in Project [12] for the HDRBs. As regards viscous and

viscoelastic dissipators, as well as shock transmitters and rolling ball systems, simplified models, based on experimental data, are in general sufficient for the analysis of structures.

- The MISS mock-up was successfully modified to allow for shake table tests using viscous and viscoelastic devices. Large benefits of such dissipators, in terms of MISS response reduction, were anticipated by preliminary calculations and confirmed by test data.

## ACKNOWLEDGMENTS

The work described in this paper was performed in the framework of the REEDS project, funded by the European Commission, in co-operation with the other partners mentioned in [4]. Particular thanks are due to Mr. G. Bonacina and Mrs. G. Bergamo of ISMES, Mr. F. Bettinali of ENEL, Mr. R. Medeot, former FIP Industriale responsible for the REEDS project, Mr. G. De Canio and Mr. G. Venturi of ENEA and Prof. F. Cesari of LIN: their names were not included among those of co-authors only due to the limit to five co-authors which was allowed for this paper.

## REFERENCES

1. Forni, M., Martelli, A., Spadoni, B., Venturi, G., Dusi, A., Bettinali, F., Bonacina, G., Pucci, G., Marioni, A., Mazzieri, C. and Cesari, F., "Development and Validation of FEMs for the Design and Qualification of HDRBs," *Trans. of the 14<sup>th</sup> International Conference on Structural Mechanics in Reactor Technology*, Vol. 7, pp. 491-498, Lyon, France, August 1997.
2. Dusi, A., Bettinali, F., Forni, M., Martelli, A., Indirli, M., Bonacina, G., Pucci, G., Marioni, A. and Mazzieri, C., "Experimental and Numerical Evaluation of Benefits of Optimized HDRBs for Seismic Isolation," *Trans. of the 14<sup>th</sup> International Conference on Structural Mechanics in Reactor Technology*, Vol. 7, pp. 507-514, Lyon, France, August 1997.
3. Martelli, A., Forni, M., Dusi, A., Bonacina, G. and Sanò, T., "Seismic Risk Reduction in Italy through Innovative Techniques: 1 - Progress of R&D on Seismic Isolation," *Trans. of the 15<sup>th</sup> International Conference on Structural Mechanics in Reactor Technology*, Seoul, Korea, August 1999.
4. Enel, Alga, Bouygues, Enea, Fip Industriale, Ga, Ismes, Ist, Lin, Jrc and Tarrc, *REEDS: Optimization of Energy Dissipation Devices, Rolling Systems and Hydraulic Couplers for Reducing Seismic Risk to Structures and Industrial Facilities*, EC Contract BRPR-CT96-0141, Project BEE1031, Bruxelles, Belgium, 1996.
5. Fip Industriale, Ist, Urom, Auth, Enea and Jrc, *ISTECH: Development of Innovative Techniques for the Improvement of Stability of Cultural Heritage, in Particular Seismic Protection*, EC Project PL950852, Bruxelles, Belgium, 1995.
6. Arato, G.B., Forni, M., Indirli, M., Martelli, A., Castellano, M.G. and Medeot, R., "Application of Antiseismic Techniques to the Seismic Retrofit of Italian Cultural Heritage Damaged by Recent Earthquakes," *Proc. of the Monument-98 - Workshop on Seismic Performance of Monuments*, pp. 229-238, Lisboa, Portugal, November 1998.

7. Martelli, A. and Forni, M. (eds.), *Seismic Isolation, Passive Energy Dissipation and Active Control of Seismic Vibrations of Structures - Proceedings of the International Post-SMiRT Conference Seminar, Taormina, Italy, August 25 to 27, 1997*, GLIS, Bologna, Italy, 1998.
8. Bettinali, F., Dusi, A., Dumoulin, C., Baumann, H., Forni, M., Martelli, A., Medeot, R., Serres, E., Bonacina, G., Azevedo, J.J., Renda, V., Cesari, F., Fuller, K.N.G., Mortier, C. and Nuti, C., "Progress of Applications, New Projects, R&D and Development of Design Rules, for Base Isolation and Passive Energy Dissipation of Civil Buildings, Bridges and Nuclear and Non-Nuclear Plants in the EC Countries," *Seismic Isolation, Passive Energy Dissipation and Active Control of Seismic Vibrations of Structures - Proceedings of the International Post-SMiRT Conference Seminar, Taormina, Italy August 25 to 27, 1997*, pp. 57-68, Taormina, Italy, August 1998.
9. Marioni, A., Doumoulin, C., A., Forni, M., Martelli, A., Bettinali, F., Dusi, Castellano, M.G., Medeot, R., Serres, E., Bonacina, G., Azevedo, J.J., Renda, V., Cesari, F., Fuller, K.N.G. and Ahmadi, H.R., "Development and Application of Innovative Energy Dissipation Systems in the EC Countries - Part 1: EC Project REEDS," *Seismic Isolation, Passive Energy Dissipation and Active Control of Seismic Vibrations of Structures - Proceedings of the International Post-SMiRT Conference Seminar, Taormina, Italy August 25 to 27, 1997*, pp. 311-330, Taormina, Italy, August 1997.
10. Forni, M., Martelli, A., La Grotteria, M., Simoncini, M., Dusi, A., Bettinali, F., Bergamo, G. and Bonacina, G., "Progress of Activities Performed in Italy by ENEA and ENEL on Seismic Isolation and Passive Energy Dissipation," *Proc. of the 1998 ASME-Pressure Vessel and Piping Conference, PVP-Vol. 379 (Seismic, Shock and Vibration Isolation - 1998)*, pp. 19-41, San Diego, CA, USA, July 1998.
11. Cook, J.W., Muhr, A.H., Sulong, M. and Thomas, A.G., "Rolling Ball Isolation System for Light Structures," *Seismic Isolation, Passive Energy Dissipation and Active Control of Seismic Vibrations of Structures - Proceedings of the International Post-SMiRT Conference Seminar, Taormina, Italy August 25 to 27, 1997*, pp. 795-811, Taormina, Italy, August 1997.
12. Enel, Alga, Dywidag, Enea, Mrpra, Shw, Stin, *Optimization of Design and Performance of High Damping Rubber Bearings for Seismic and Vibration Isolation*, EC Contract BR2 CT93 0524, Project BE7010, Bruxelles, Belgium, 1993.