

Large Scale Seismic Proving Test of BWR Reactor Pressure Vessel by TADOTSU Table

T. TAIRA, Y. SASAKI

Toshiba Corporation, Kawasaki, Japan

H. SHIBATA

University of Tokyo, Tokyo, Japan

H. SATO

Mechanical Engineering Laboratory, MITI, Tokyo, Japan

T. KUBO

Nagoya Institute of Technology, Nagoya, Japan

S. KAWAKAMI, T. OHNO, Y. KARASAWA

Nuclear Power Engineering Center, Tokyo, Japan

ABSTRACT

A series of seismic proving tests for PWR and BWR facilities have been programmed and conducted by the Nuclear Power Engineering Center (NUPEC) under the sponsorship of the MITI (Ministry of International Trade & Industry).

The seismic proving test (the first test in the world as an actual suitable scale model) described in this report was conducted from 1989 to 1990 for Reactor Pressure Vessel of the Boiling Water Reactor (herein after, called as BWR-RPV).

The project testing was performed using the large scale, high-performance shaking table of NUPEC in Tadotsu, Kagawa prefecture.

This paper deals with an experimental research project to demonstrate the seismic reliability proving test for BWR-RPV in the nuclear power plant facilities.

1. INTRODUCTION

The seismic proving test for the BWR-RPV is the 8th program in the projects.

Main items to be dealt with this particular program can be summarized as follows.

- (a) Confirmation of the structural strength of the BWR-RPV to withstand large earthquakes.
- (b) Confirmation of pressure boundary function during earthquake, S_1 and S_2 seismic wave.
- (c) Confirmation of the applicability of the current seismic design procedures.

The various test data required for i) verification of the adequacy of the seismic design analysis method, ii) confirming vibration characteristic of the test model iii) proving the seismic safety, reliability and strength of BWR-RPV during S_1 and S_2 seismic wave, were obtained in this test.

This paper presents briefly only features and the summary of the detailed analysis and evaluation for the experimental results obtained through particularly important test stage; strength proving test and marginal proving test, with some concrete examples.

Moreover, in this paper, simulation analysis results are abbreviated. They will be presented as the series papers of the simulation study for the follow-up survey in the next conference.

2. TEST MODEL

The test model is a reduced scale (one by two) mock-up of the Reactor Pressure Vessel for the improved and standardized 1,100MWe BWR plant for a high seismic zone.

The test model utilized for this program is illustrated schematically in Fig.1.

The test model (whose structure was as close as possible to that for the actual plants) mounted on a large scale, high-performance shaking table. The key structural components of the BWR-RPV test model are: Reactor Pressure Vessel, RPV-Skirt, Anchor Bolt, RPV-Stabilizer.

Among those, former three components are simulated as reduced scale model (one by two).

Stiffness of stabilizer with the structure and component in the same way to those of actual components are made just in order to simulate the dynamic vibrational characteristics of the actual RPV, as closely as possible.

The rigidity of the base support structure was sufficient to minimize the dynamic influence on the BWR-RPV system.

Therefore, the vibration characteristics of the test model is approximately equal to that of an actual plant.

Materials of the model components were selected to be equivalent to those of actual components to prove the seismic safety and structural reliability based on the current standards.

The rigidity of the support structure was sufficient to minimize their dynamic influence on the BWR-RPV.

Total weight of test model is about 600ton.

3. SEISMIC TEST METHODOLOGY

3.1 TEST STAGES

In order to achieve the purpose of this test, several test stages were programmed according to the predetermined procedures, as shown in Fig.2.

This paper presents only the summary of the experimental results obtained through particularly important test stage; strength proving test and marginal proving test.

3.2 SEISMIC INPUT WAVE FOR EXCITATION

The seismic input waves for excitation were selected in such a way that the BWR-RPV was subjected to the largest response and the severest test results could be obtained, according to the following procedure as shown in Fig.3. Floor response acceleration time histories at the top of the Reactor Pressure Vessel pedestal were calculated before the test using an analytical model of the standard BWR actual reactor building subjected to S_1 and S_2 earthquake motions. These earthquakes have been standardized by MITI based on the highest seismic risk zone in Japan.

After review and discussions, the seismic input wave shown in Table 1 were established for the proving test.

3.3 TEST CONDITIONS AND MEASUREMENT

a) Environmental Condition

The seismic proving tests for BWR-RPV were conducted under conditions as near as possible to those for an actual system, condition.

Vibration test were carried out with the test model filled with water at room temperature, normal atmospheric and hydrostatic pressure, and also actual pressure ($70.7\text{kgf/cm}^2\text{g}$).

b) Excitation Method

As for the excitation directions, the test model was excited simultaneously bi-direction; horizontally (X-axis direction) and vertically (Z-axis direction).

c) Measuring Method

Response acceleration, stress, displacement, etc. were measured at the major points on the test model and the shaking table. Moreover, measuring points were about 330 points, in order to obtain the overall response distribution and behavior.

4. TEST RESULTS

4.1 VIBRATION CHARACTERISTICS OF BWR-RPV

The data required for verification of the current seismic design analysis method are obtained in this test.

Vibration and response characteristics of the test model can be described as follows.

- i) The first vibration mode shape was the bending mode of a beam, one side is fixed and the other side is free, as shown in Fig.4.
- ii) The predominant vibration frequency of RPV test model was approximately constant value according to the relative displacement, as shown in Fig.5.
- iii) The vibration response direction of RPV test model was coincided with the excitation direction, as shown in Fig.6.
- iv) The relation of the reaction force and the relative displacement of the stabilizer, was bi-linear characteristics. Stiffness was approximately equal to that of the test model design value, as shown in Fig.7(1).
Moreover, collision waves based on the stabilizer gap were not observed during earthquake excitation, as shown in Fig.7(2).
- v) Vibration characteristics (transfer function) was non-linear characteristics with the hard-spring type. However, the relation between the test response stress, acceleration at the major points and the output acceleration on the table showed an approximate linearity, as shown in Fig.8.
- vi) The maximum response acceleration for the main components of the BWR-RPV test model under bi-axial simultaneous excitation and those under one directional horizontal excitation were compared, as shown in Fig.8.

The result exhibited that the response were not affected by the vertical excitation.

- vii) The model damping ratio, estimated by various data and methods, were larger than the current design value, as shown in Fig.9. This estimated damping ratio shall be applied to the simulation analysis.

4.2 RESULTS FROM PROVING TEST

The results in the strength proving test and marginal proving test are described below.

The strength proving test was opened to the public to inform people inside and outside the country.

4.2.1 STRENGTH PROVING TEST

The maximum principal stress values for the main components of the model for S_1 and S_2 earthquake wave were significantly lower than the allowable levels given by the seismic design standard. Therefore, BWR-RPV test model had sufficient strength to withstand seismic excitation having excess levels, as shown in Table 2.

Earthquake excitation tests were carried out for verification of the load combination with pressurized load and earthquake load in the strength design of the actual plant. These tests were carried out under the normal pressure condition and the actual pressure condition with the test model filled with water, respectively. From these two test stages result, response stresses for earthquake excitation were almost similar, regardless of the pressure condition in the RPV test model.

Consequently, the adequacy of the load combination in the strength design was confirmed.

4.2.2 MARGINAL PROVING TEST

Marginal proving test for the BWR-RPV was carried out under S_2 earthquake excitation in the horizontal and vertical directions, simultaneously.

In this test, the acceleration level of the applied S_2 wave was 1.7 times that of S_2 proving test and was almost limitation at the performance capacity of the shaking table. In this test, the maximum principal stress for the main components of the test model was lower than the allowable stress intensity value. This response stress was 1.5 times that of the proving target (the round value of actual plant design value), as shown in Table 2.

4.2.3 INSPECTION RESULTS AFTER TEST

The inspection results were carried out for the test model, after the strength proving test, marginal proving test, respectively. And, the abnormal phenomenon (damage or deformation on test model) had not been observed. From these results, the integrity of strength, pressure boundary function and the supporting capability were proved.

5. CONCLUSION

The results of the seismic reliability proving test can be concretely summarized as follows.

- i) The structural and functional integrity for the BWR-RPV test model was confirmed and also the sufficient margin in strength for S_1 and S_2 earthquake wave and for severer earthquakes up to 1.7 S_2 was confirmed.
- ii) Abnormalities were not found in the inspection. BWR-RPV pressure boundary function and supporting capability were maintained under the seismic motion.
- iii) From the evaluation results of test data mentioned in Section 4.1, it could be concluded that the linear analysis method will be able to use for the earthquake response analysis method, BWR-RPV will be able to be replaced with a single elastic beam for bending and shear deformation.

Moreover, the above evaluated numerical analytical model and analysis method is similar to the current seismic design codes and procedures.

The following vibrational behaviors of RPV were also observed. That is, the non-linear vibration characteristics were occurred by the gap element of the stabilizer. However, the relation between the earthquake response value and table output acceleration showed an approximate linearity. The vibrational motion direction of the RPV top was coincided with the excitation direction.

These results indicate that the assumption on the seismic analysis of the BWR-RPV is reasonable, i.e., mathematical model of RPV can be replaced with the single elastic beam.

- iv) The modal damping ratio, estimated by various data and methods, were larger than the current design value. This estimated damping ratio shall be applied to the simulation analysis.

REFERENCE

- (1) M.Watabe, H.Shibata and T.Ohno (1987), "Seismic Proving Test Program for Nuclear Power Plant in Japan", Transactions of 9th International Conference on Structural Mechanics in Reactor Technology (SMiRT-9), Lausanne, Vol K2 p517~p522.
- (2) H.Shibata, H.Sato, K.Suzuki, T.Ohno and T.Taira, et.al. (1989), "LARGE SCALE SEISMIC PROVING TEST OF BWR CORE INTERNALS BY TADOTSU SHAKING TABLE", THE 1989 ASME PVP Conference -JSME Co-sponsorship, HAWAII, VOL.182, P339~P344.

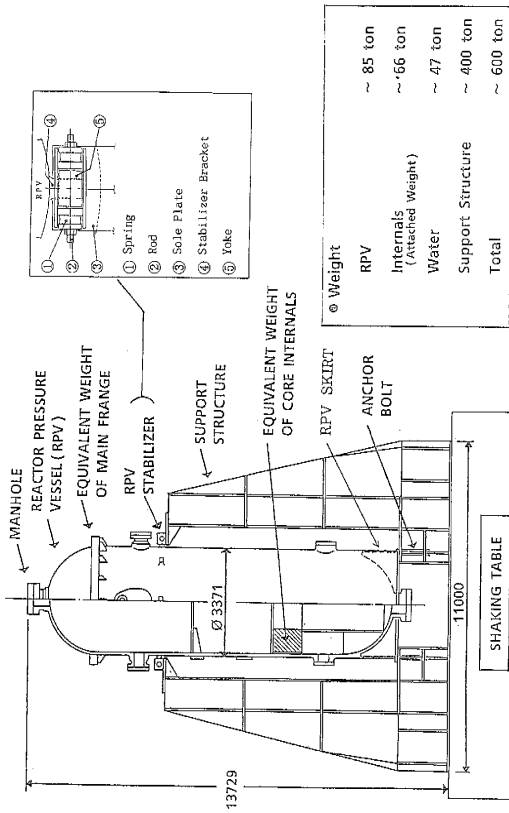

Fig. 1 Seismic Proving Test Model for BWR Reactor Pressure Vessel

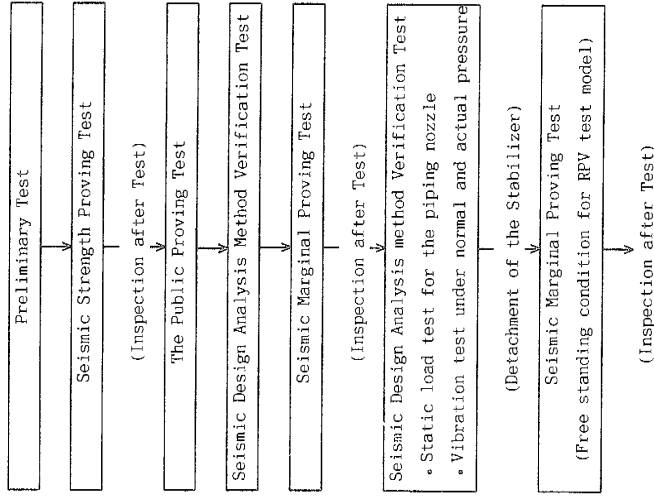

Fig. 2 Seismic Proving Test Procedure

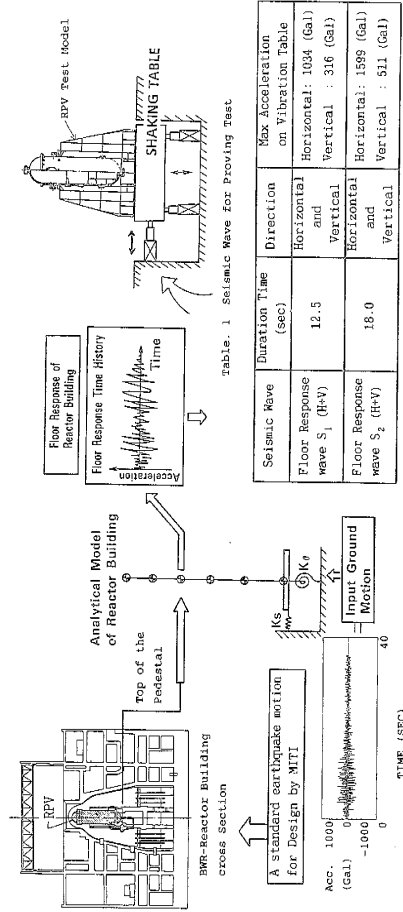

Fig. 3 Selection Procedure of Seismic Wave for Proving Test

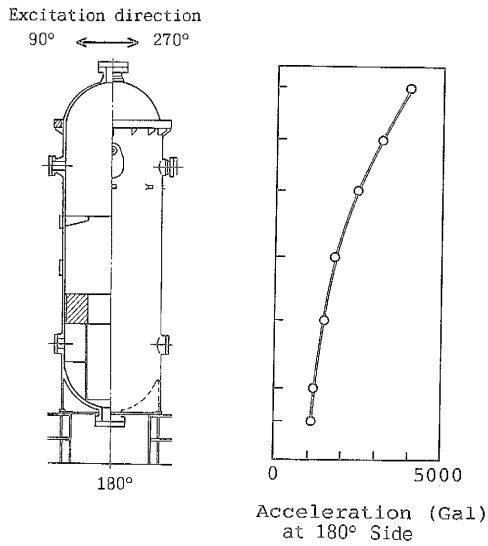

Fig. 4 Vibration Mode of RPV Test Model

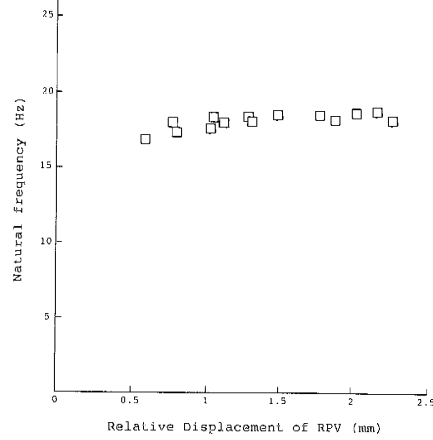

Fig. 5 Effect of Relative Displacement on Natural Frequency

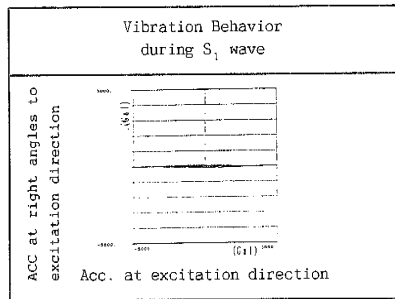

Fig. 6 Vibration Behavior of RPV Top

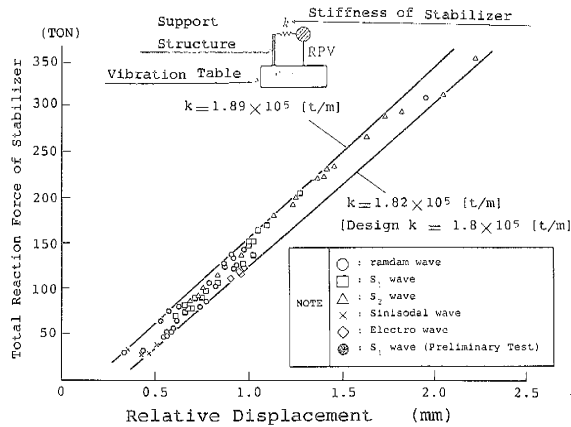

Fig. 7(1) Relation between relative displacement and Reaction Force of Stabilizer

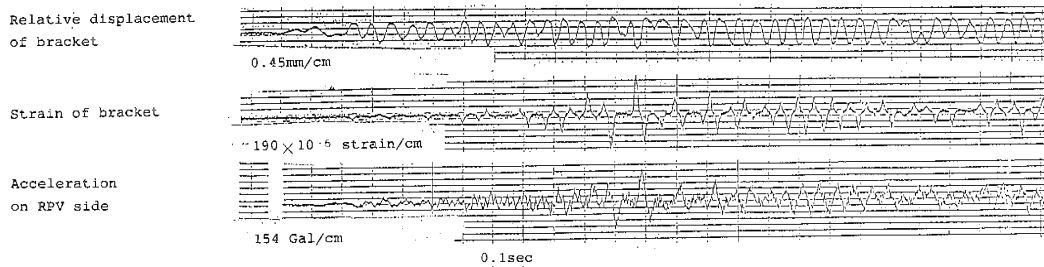

Fig. 7(2) Observation for Vibration at the Stabilizer Gap

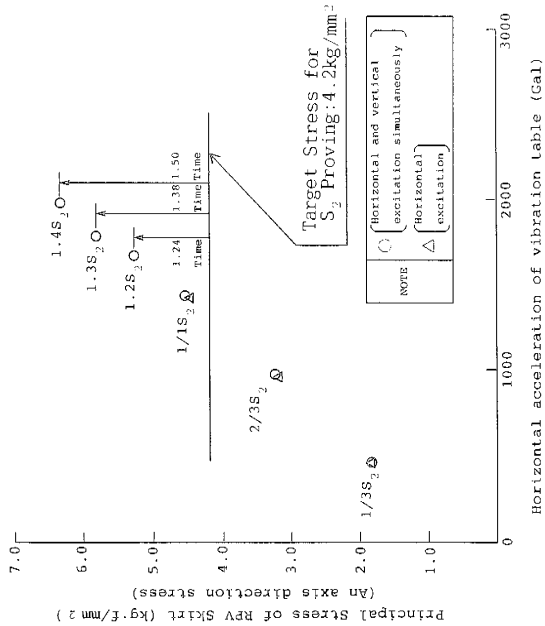

Fig. 8 Linear Response Characteristics

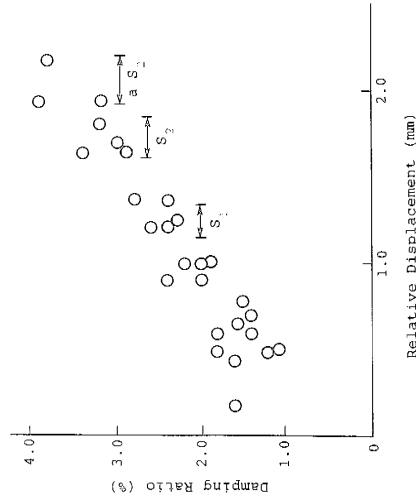

Fig. 9 Damping Ratio of RPV Test Model

Table.2 Max Measured Stress Intensity Value

Unit : kgf/mm²

Test Contents	Strength Proving Test		Marginal Proving Test	S ₂ wave
	S ₁ wave	S ₂ wave	S ₂ wave	
Items	measured stress intensity	allowable value (IIIAS) PL + Pb	measured stress intensity	allowable value (IIIAS) PL + Pb
Main Component				
Total Reaction Force of RPV Stabilizer	203.3 (TON)	190 TON (Target value)	289.5 (TON)	270TON (Target value)
RPV Stabilizer (Yoke)	1.7	23.0 (Pm)	2.5	27.6 (Pm)
RPV Stabilizer Bracket (installation to vessel)	7.9	52	10.3	56.0
RPV Supporting Skirt (installation to vessel)	2.4	52.5	3.3	56.0
RPV Supporting Skirt (skirt end)	4.1	52.5	6.0	56.0
Anchor Bolt	30.0	52.5 (Pm)	30.1	52.5 (Pm)

