

ADAPTATION OF HIGH VISCOUS DAMPERS (HVD) FOR ESSENTIAL DECREASING OF IN-STRUCTURE FLOOR RESPONSE SPECTRA

Victor V. Kostarev

*CKTI-Vibrozeism Co. Ltd., St. Petersburg,
Russian Federation*
Phone: +7 812 327 8599,
Fax: +7 812 327 8599
E-mail: vvk@cvs.spb.su

Andrei V. Petrenko

*CKTI-Vibrozeism Co. Ltd., St. Petersburg,
Russian Federation*
Phone: +7 812 327 8599,
Fax: +7 812 327 8599
E-mail: andrey@cvs.spb.su

Peter S. Vasilyev

*CKTI-Vibrozeism Co. Ltd., St. Petersburg,
Russian Federation*
Phone: +7 812 327 8599,
Fax: +7 812 327 8599
E-mail: peter@cvs.spb.su

Karl-Heinz Reinsch

*GERB Schwingungsisolierungen GmbH &
Co KG, Berlin, Germany*
Phone: +49 30 41 91 110,
Fax: +49 30 41 91 139
E-mail: karl-heinz.reinsch@gerb.de

ABSTRACT

This paper concerns a further development of High Viscous Damper (HVD) approach for essential decreasing of structure's floor response spectra. Usually restraining of components and pipelines by HVD is used for significant decreasing of operational vibration and seismic loads. A new approach consists of dampers installation for essential upgrading of a whole system's damping that is much more efficient in both technical and economical points of view than restraining of each component of the system. In that way using of HVD means high energy dissipation for whole dynamic system "Building-Components" subjected to the base seismic or other extreme load excitation.

The specific feature of each NPP site is an existing of a few closely spaced buildings: reactor building, turbine hall and so on. As the rule such buildings play sufficiently different roles in NPP operation and therefore have sufficiently different design, natural frequencies (periods) and distortion of floors and different rocking modes on a soil. The main idea explained in the paper is an interconnection of buildings by HVD. Then differences in their mechanical properties provide their out-of-phase relative motions during an earthquake and therefore effective dissipative work provided by HVD devices. At the same time implementation of HVD approach allows to eliminate possible interactions and collisions in the gaps between building structures that wears potential threat of building failure.

The detailed 3D finite element models of reactor building, turbine hall and special building were developed for NPP with VVER-1000 MWt reactor type. Performed analysis has shown high efficiency of suggested approach for protection of buildings, structures, systems and components against seismic and other impacts.

Keywords: Damper Structure Component Floor Response Spectra

1. INTRODUCTION

Nowadays VES and VD High Viscous Dampers (HVD), manufactured by GERB GmbH are well-known source for providing dynamic safety for piping, components and systems. Several thousands of HVD have demonstrated their effectiveness and reliability at nuclear and conventional power plants, heavy industry and chemical facilities in the last twenty years of the extensive worldwide usage (Berkovski, 1997), (Fomin, 2001), (Katona, 1994) and (Masopust, 1994).



Fig. 1 VD-Damper Installed on Pipeline of NPP (Turbine Hall)

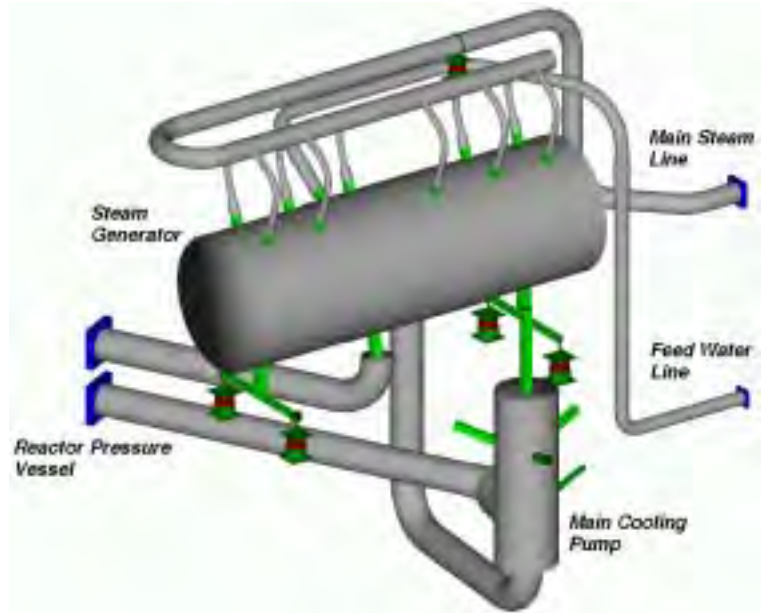
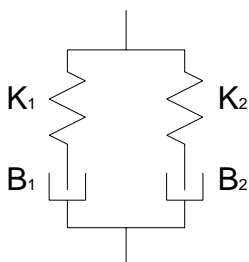

Fig.2 VD-Dampers Installed on Primary Coolant Loop of NPP (Reactor Building)

The wide spreading of HVD is determined by its unique capabilities and obvious advantages to other devices:

- To reduce vibration and dynamic response of systems in all degrees of freedom by tremendous increasing of system's damping with possibility to tune to optimal damping;
- To develop high damping forces under any dynamic impact whereas slow motions are free;
- To react on vibration immediately without any delay;
- Stability to high temperature, humid, toxic and radiation environment;
- Maintenance free design and handling. No parts for wear and tear. Cost-effective solution.



*Fig.3 Model of HVD
(K_1, K_2 – Stiffness,
 B_1, B_2 – Damping)*

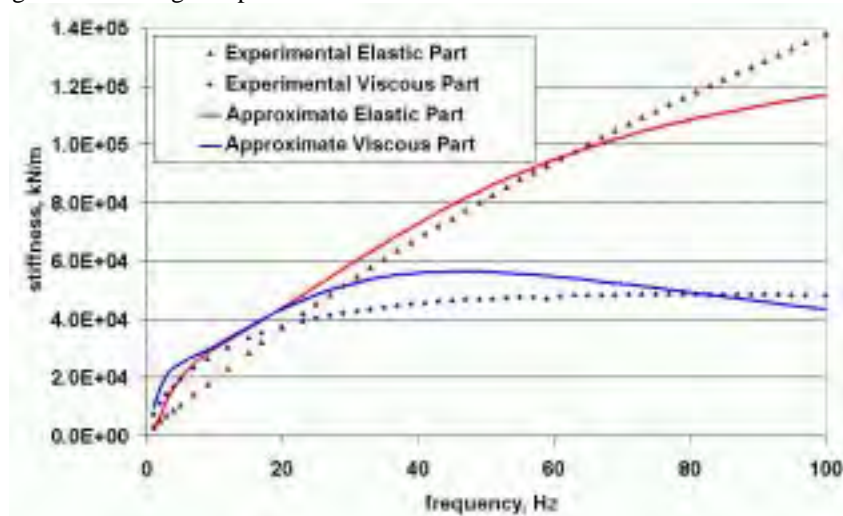

*Fig.4 Dynamic Stiffness of HVD
(Corresponding to the Model and Experimental)*

Each HVD type has a mathematical model based on the parameters determined by numerous experiments (see in fig. 3). The comparison of the experimental characteristics with the characteristics corresponding to the mathematical model for “VD-630/325-15” damper is shown in fig. 4 (Kostarev, 1994). There can be significant both conservative and nonconservative errors in the case of simplified or ideal damper HVD models using for analysis purposes (Berkovski, 1995). The procedure of the selection of the HVD type and their number for any pipeline system is implemented in piping analysis software dPipe (CKTI-Vibroiseism) and can also be fulfilled with the help of any general-purpose finite element software.

2. HVD-APPROACH: USING VD DAMPERS FOR THE SYSTEMS WITH DIFFERENT DYNAMIC PROPERTIES

Energy dissipation plays positive role providing reducing of response motion during dynamic extreme loads such as earthquake, explosion etc. At the same time structure’s inertial loads and components also decrease. Usually the energy dissipation level of NPP buildings and structures is considered in the range of 2 – 10% modal damping and it corresponds to the response motion on the general mode shapes. Application of additional devices for further increasing of a structure’s energy dissipation could bring significant positive effect in decreasing all-structure dynamic response. Historically a great number of the devices based on dry friction, viscous and internal hysteretic damping was used for resolving specific problems of seismic base isolation.

The proposed method of High Viscous Damper (HVD-approach) is also oriented on increasing of total energy dissipation of NPP buildings and structures. From this point of view the degree of dissipation increment determines the efficiency of reducing of inertial loads and response motions excited by the external dynamic loads. The main idea of HVD-approach is to use general systems or subsystems that can independently move about each other under external loads. Then such their property can be used for efficient energy dissipation by VD dampers connection of system to system or subsystems.

The linear system of two oscillators is considered to evaluate the efficiency of HVD-approach and the probable area of its application (see in fig. 5). Each oscillator is defined by its mass m_i , natural frequency f_i and modal damping ξ_i for $i = 1, 2$. These oscillators are assumed to be connected with the help of the some number of VD dampers. The number of dampers can be varied. The synthesis acceleration made with the help of standard response spectrum is used to define earthquake excitation with intensity of 0.2 g (see in fig.6).

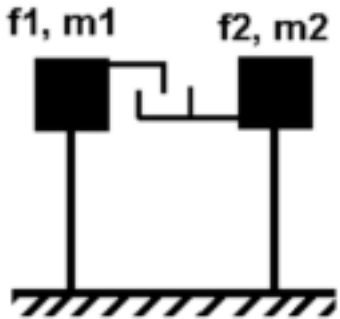

Fig.5 System of Two Oscillators

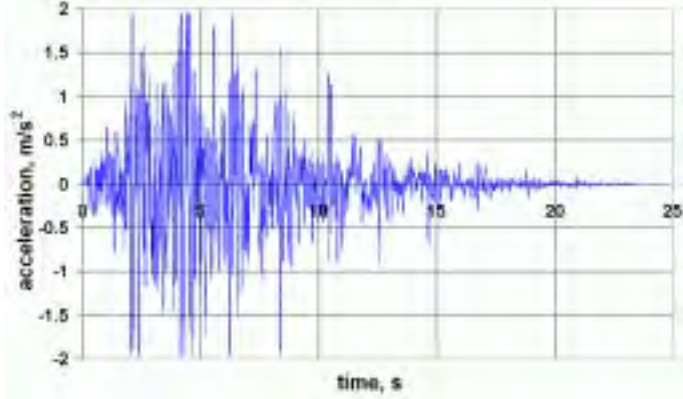

Fig.6 Free Surface Seismic Horizontal Acceleration

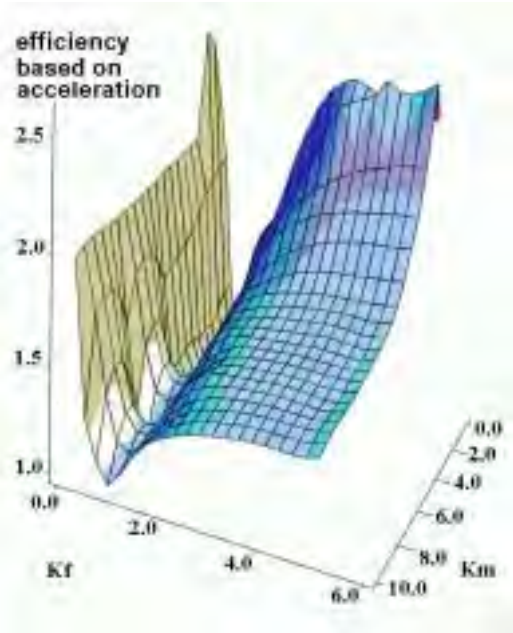

Fig.7 HVD-Approach Efficiency (Modal Damping 4%)

It is assumed for instance that the properties of the first oscillator are $m_1 = 3.3 \cdot 10^7$ kg, $f_1 = 5.2$ Hz, $\xi_1 = 4\%$. At the same time the modal damping of the second oscillator is defined constant as $\xi_2 = 4\%$ but its mass and natural frequency are varied. The time history dynamic analysis for the system of oscillators is carried out for the various pairs of (m_2, f_2) to determine the efficiency of damping connection using various numbers of dampers. Under term 'efficiency' we define the ratio of maximum response acceleration of the first oscillator in the system without dampers to the same value in system with dampers. The possible range of number of dampers is considered from 10 up to 500. The further increasing of the number of dampers has no sense from technical and financial points of view and since the corresponding viscous-elastic connection becomes totally elastic and rigid (see in fig.4). The additional parameters $K_m = m_1 / m_2$ and $K_f = f_1 / f_2$ are used to vary the properties (m_2, f_2) of the second oscillator. They are changed in the following ranges: $K_m = 0.1 \div 10.0$, $K_f = 0.2 \div 5.0$.

The surface of efficiency was determined as the result of multi-step seismic analysis with numerous different values of parameters K_m and K_f from the ranges mentioned above (see in fig. 7). Each point of the surface corresponds to some values K_m and K_f and also to the optimal number of dampers to get the highest value of possible efficiency of HVD-approach.

The surface's valley shows that dampers do not work in the case of the equivalence of the oscillators frequencies ($K_f = 1.0$) at any value of K_m . In this situation oscillators move in-phase and have no motion about each other. On the left side of the valley there is the region with $K_f < 1.0$ corresponded to the second oscillator stiffer than the first one. This case is desirable since the efficiency of the dampers connection rises very fast and reaches the highest values. On the right side of the valley there is the part of surface with $K_f > 1.0$ for the second oscillator more ductile than the first one. In that case efficiency rises more slowly but it shows the possibility to damp a ductile system about the stiff one with the proposed approach.

Further the system of oscillators with the following parameters is analyzed: $m_1 = 3.3 \cdot 10^7$ kg, $f_1 = 5.2$ Hz, $\xi_1 = 4\%$, $f_2 = 3.07$ Hz, $m_2 = 3.6 \cdot 10^7$ kg, $\xi_2 = 4\%$. In that way the reactor building substructures, namely outer envelope and internal support structures for the reactor vessel (see the next item), are simplify modeled. The dependence of efficiency on the number of VD dampers is shown in fig.8. Additionally the efficiency based on the ratio of the energy of response motions in the system without dampers to the same value in the system with dampers is demonstrated. The energy of response motion can be evaluated with the help of integral of PSD of response acceleration through the motion duration.

As indicated in fig. 8 the 165 VD dampers provide the highest decreasing of response acceleration (efficiency based on acceleration ≈ 1.9). The number of 190-240 VD dampers allows getting efficiency based on energy about ≈ 1.8 . Such a great number of dampers is not a cost effective. However, the connection with 90-100 dampers provides rather high efficiency about $\approx 1.6 - 1.7$.

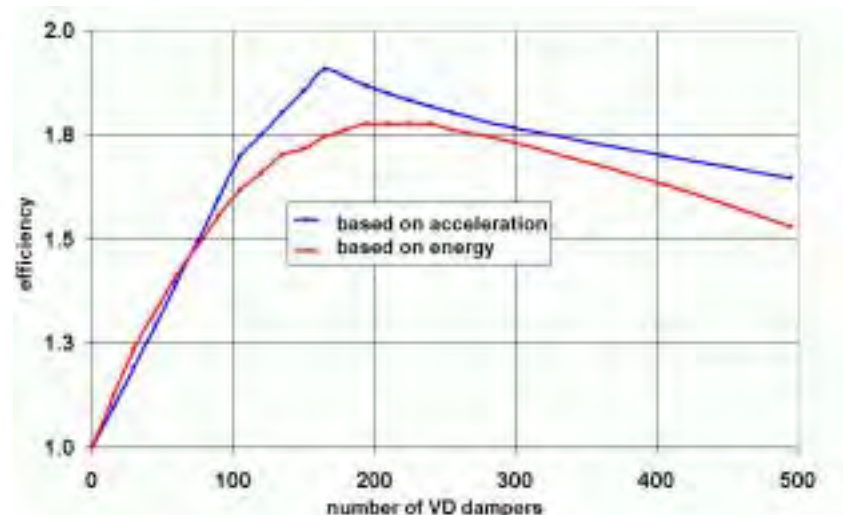

Fig.8 Efficiency of HVD-approach for “Envelope – Internal Structures” System (Two Oscillators)

It is usually important to reduce the response seismic energy on the natural frequencies of equipment as well as the total level of energy and acceleration. The response spectra and PSD of response acceleration of the first

oscillator are shown in fig. 9, 10 to demonstrate frequency distribution of seismic energy. It can be observed that the peak value of response spectrum drops twice and the peak value of PSD becomes 2.8 times less with dampers.

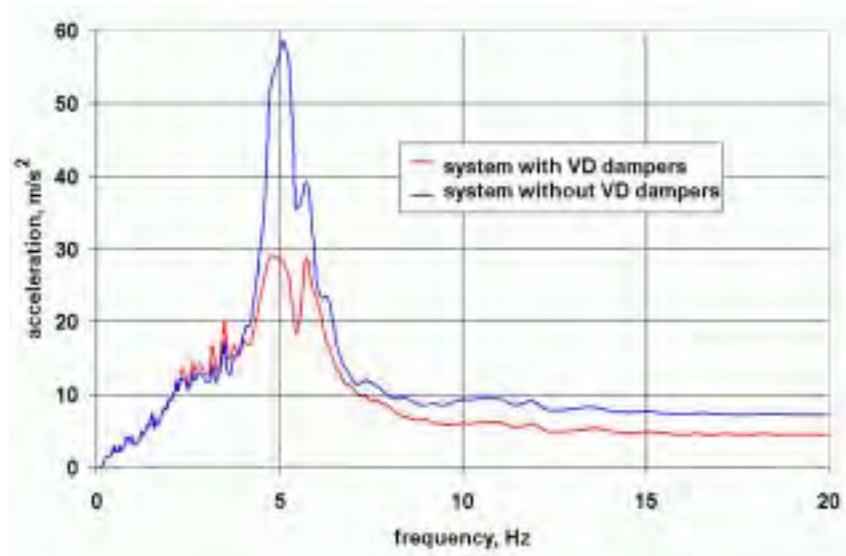

Fig.9 Acceleration Response Spectra for “Envelope – Internal Structures” System with 90 VD Dampers and without Them (Two Oscillators)

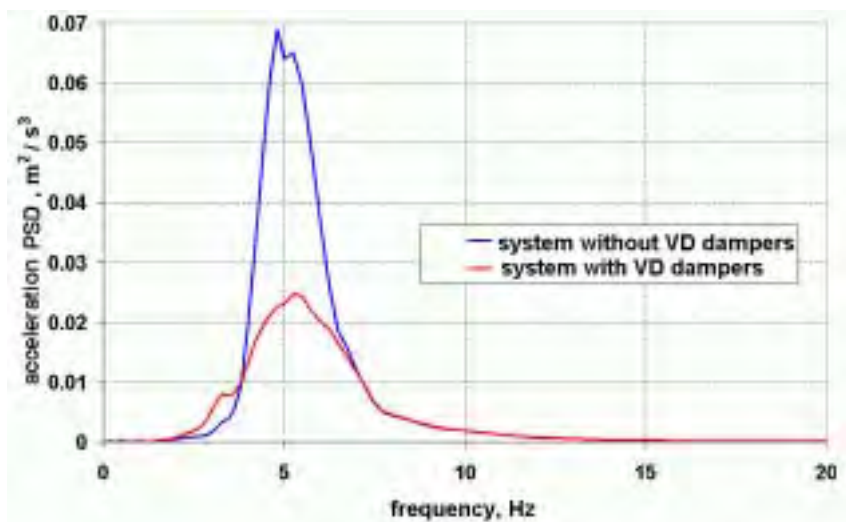

Fig.10 Power Spectral Density for “Envelope – Internal Structures” System with 90 VD Dampers and without Them (Two Oscillators)

3 USING VD DAMPERS FOR THE SUBSYSTEMS WITH DIFFERENT DYNAMIC PROPERTIES IN THE NPP REACTOR BUILDING

The efficiency of HVD-approach is analyzed on the base of the NPP reactor building of VVER-1000 type. That building is a reinforced concrete structure with pre-stressed concrete containment. The reactor building has a conventional design and consists of the following parts: fundamental part, outer envelope and internal support structures for reactor vessel. In that case the containment itself and internal structures are independent subsystems based on the common fundamental part. The independence of the containment allows avoiding additional stresses due to the possible temperature displacement during an accident. In that building scheme the upper slab of internal structures can be connected to the containment with the help of VD dampers (see in fig. 11-13). Then the accidental temperature displacements do not produce additional significant loads to the containment since they have quasistatic nature.

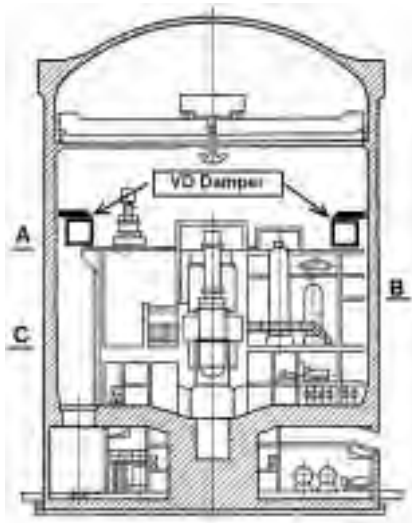

Fig.12 Vertical Section of NPP Reactor Building. The Installation of Dampers

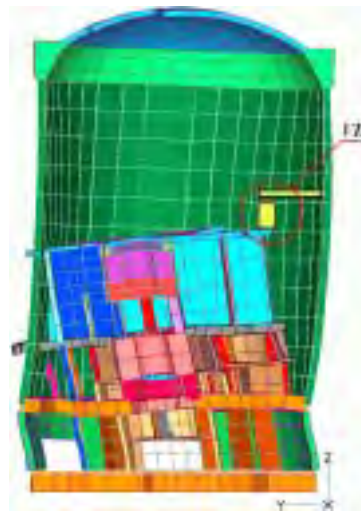

Fig.13 Spatial Model. Mode Shape with Frequency 5.2 Hz and Modal Mass 20%

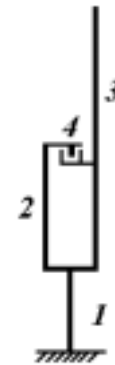

Fig.11 Stick Model

- 1 – Fundamental Part,
- 2 – Internal Structures,
- 3 – Outer Envelope,
- 4 – VD Dampers Connection

Two finite element models are developed for the reactor building based on the rock site. The first one is a simplified stick model that is widely used for the seismic design (see in fig. 11)). The second one is the detailed spatial model with the accurate modeling of the geometry and the material properties of the subsystems (see in fig. 13). The main natural frequencies of the both models are in a good accordance with each other. Their differences are less than 5%.

The reactor building has two significant natural shapes with the largest modal mass for the horizontal direction (50% и 23% of total mass) and frequencies 3.1 Hz и 5.2 Hz. One of them is demonstrated in fig.13.

On the one hand, the basic part of the earthquake energy is transmitted on the frequency range of 3 - 7 Hz. Therefore the mode shapes mentioned above are greatly excited during a possible earthquake. It means that the general response motion corresponds to the oscillations at these shapes. On the other hand, the motion at these shapes is followed by the significant relative movement of the internal structures about the outer envelope (see in fig. 13). In that case the dampers installed between such subsystems provide effective dissipation of seismic energy and decreasing the intensity of motion and inertial loads.

The seismic analysis is carried out to determine the optimal number of VD dampers in proposed connection with the help of both stick and spatial models. The horizontal ground acceleration is used with the spectrum shown in fig. 16. As the result of the analysis the efficiency of decreasing of response acceleration and energy for level A of internal structures is investigated (see in fig. 14, 15).

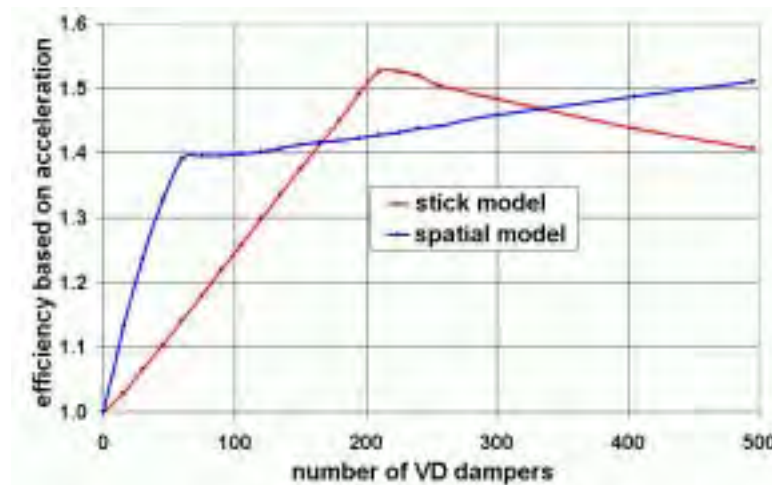

Fig.14 HVD-approach Efficiency Based on Acceleration

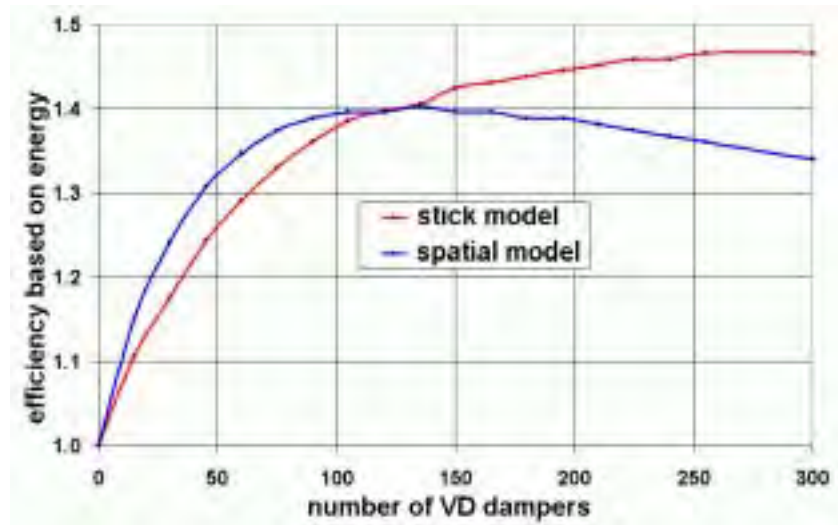

Fig.15 HVD-approach Efficiency Based on Energy

It can be observed that the obtained efficiency of HVD-approach is significantly different for spatial model, for stick model and for the system of the oscillators (fig. 8). This result proves that the dampers efficiency depends on the local features of the connected structures as well as on their global dynamic properties: masses, damping levels and frequencies. Therefore, the final solution on an optimal number of dampers should be done on the base of the detailed spatial model of the building. In current case the number of 90 VD dampers is the optimal to be installed in the reactor building and actually is a cost effective decision considering number of devices needed for restraining of numerous safety related components in the building (see in fig. 14, 15).

For currently investigated building it was shown that the most efficiency of HVD approach could be achieved in case of the rock base or hard soil conditions representing majority of the reactor building installations (Kostarev, 2003). So that case is assumed further.

The additional analysis of the building with 90 dampers and without them is performed under loads of plane crash and explosion. The time history dependency of explosion pressure is represented in fig.17. The two points of the top of the reactor building are chosen as the possible places of the plane crash impact (see in fig. 18). The military Phantom plane is considered with the time history impact force shown in fig.19.

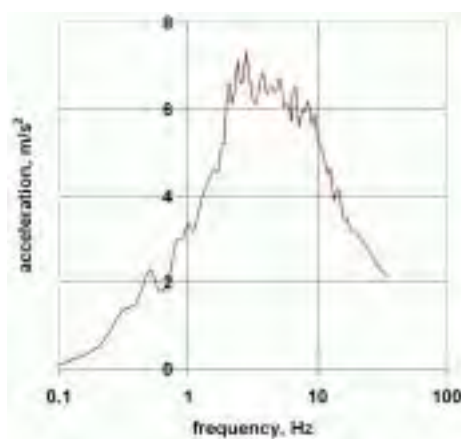

Fig.16 Seismic Response Spectrum (Damping 4%)

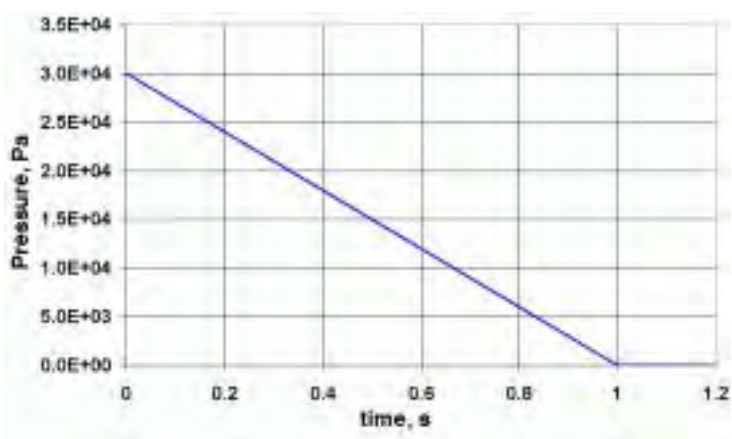

Fig.17 Explosion Wave Pressure

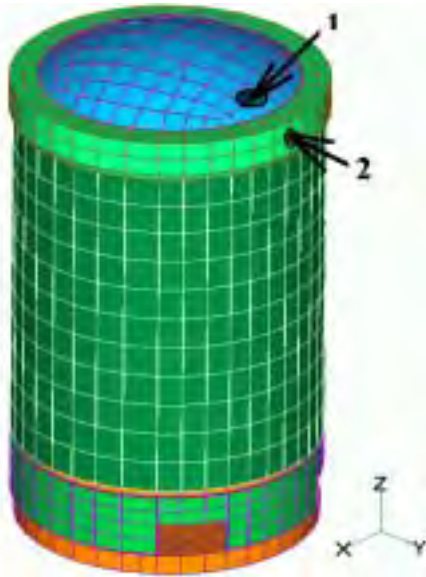

Fig.18 Plane Crash Points

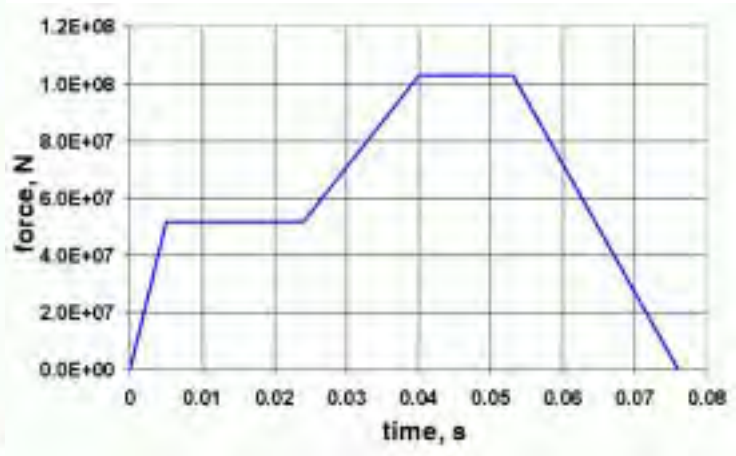

Fig.19 Phantom's Crash Load

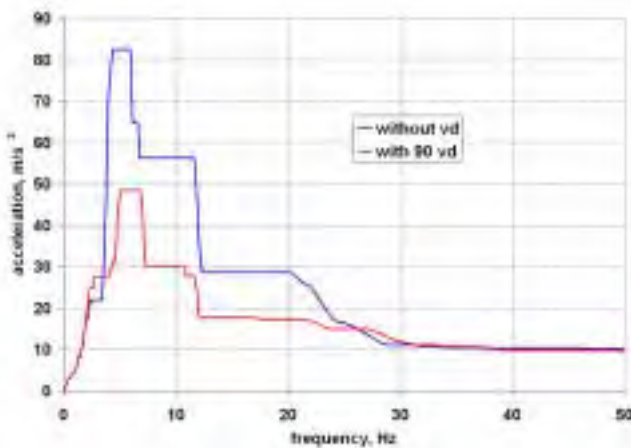

Fig.20 Broaden Envelope Response Spectra for Internal Structures at Level A (Explosion, Plane Crash u Earthquake)

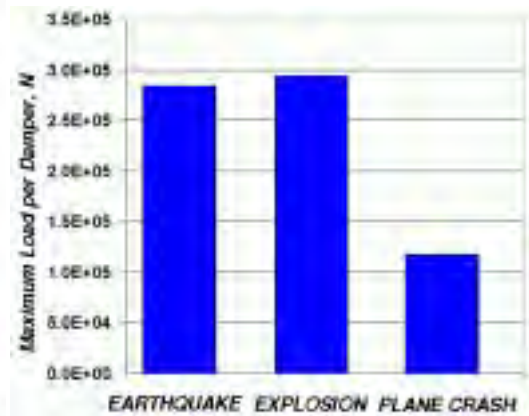

Fig.21 Maximum Time History Load on the VD Damper

As the result the broaden envelope spectra are obtained for all considered external loads: earthquake, plane and explosion. Such spectra for level A (see in fig. 20) and the values of accelerations in Table 1 show high efficiency of dampers for reducing inertial loads on the equipment supported by building structures under general kinds of external events. At the same time the maximal Time History acceleration decreases by up to 50% and the maximal spectra acceleration reduces by up to 70%.

The performed dynamic analysis allows evaluating maximal time history dynamic loads acting in each VD dampers during external events. The corresponding values are shown in fig.21. For the currently used dampers the safe load is $3.5 \cdot 10^5$ N per device. It means that the condition of load capacity is met.

Moreover the maximal total seismic forces and moments are determined in the horizontal section of building (see in fig 22, 23). Generally they are also reducing by 15-20% that proves also the efficiency of HVD-approach.

Table 1 Maximal Time History and Spectral Acceleration for Reactor Building under Earthquake, Plane Crash Impact and Explosion with and without HVD (rock base)

Reactor Building Part	Maximal Time History Acceleration, m/s^2	Maximal Spectral Acceleration, m/s^2 (damping 2%)
-----------------------	--	---

		Without HVD	With 90 HVD	Without HVD	With 90 HVD
level	A	10.2	6.8	82.5	48.5
	B	8.2	5.6	67.2	39.0
	C	6.8	5.0	58.9	35.0
Top of the Containment		9.7	9.4	81.7	79.1

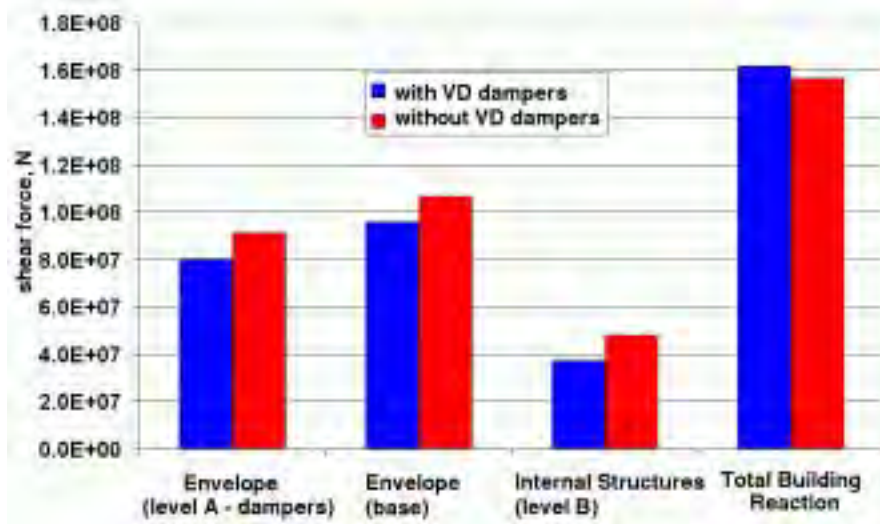

Fig.22 Maximal Total Shear Forces in Horizontal Sections of the Reactor Building under Earthquake

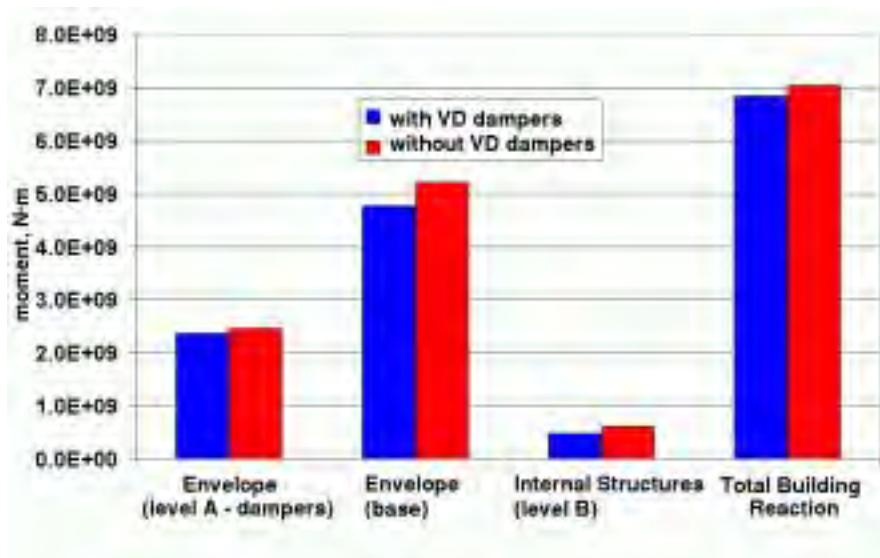

Fig.23 Maximal Total Bending Moment in Horizontal Sections of the Reactor Building under Earthquake

4 USING VD DAMPERS FOR THE SYSTEMS WITH DIFFERENT DYNAMIC PROPERTIES - NPP ADJACENT BUILDINGS

The proposed HVD-approach may be used successfully for the adjacent buildings with the different dynamic properties. The NPP buildings are most suitable for this. On the one hand, the NPP buildings should stay near each other to provide all necessary functional interconnections. Usually such buildings are connected with a great number of pipelines, electric cable trays and so on. On the other hand, the main NPP buildings are used for absolutely different purposes. Thereby they have dissimilar structure and accordingly the different dynamic

properties. The consideration of the most important building of NPP with VVER-1000 MWt reactor type follows below.

The reactor building has a massive structure made of reinforced concrete. There are usually one or two independent protective containment or/and structures with eigenvalues about 3-5 Hz of main bending mode shapes. At the same time there are the fundamental part and sometimes the auxiliaries with the stiff reinforced concrete structure. Usually the eigenvalues of general mode shapes of the whole reactor building are in the range of 1.5 – 4.0 Hz taking into account soil conditions.

The turbine hall building may consist functionally of several parts. Some of them are stiff and made of reinforced concrete. The others are flexible skeleton structures with columns and girders. The eigenvalues of the main mode shapes can be about 1 Hz for the turbine hall with the described structure. The reactor building and the turbine hall should be neighbor because they are connected by means of the system of the pipelines of steam and feed water.

The special building adjoins to the reactor building and it is responsible for the processing of liquid radioactive wastes. It has stiff structure made of reinforced concrete. The corresponding eigenvalues of the main mode shapes of the rocking of the building on soil can be in the range of 5.0 – 10.0 Hz.

The argumentations represented above are followed by the conclusion about principal possibility of usage of HVD-approach for the main NPP buildings. For example, the efficiency of HVD-approach is analyzed on the base of the reactor building and the special building (see in fig. 24). The possible case of VD dampers installation to connect the buildings is shown in fig. 25. The higher care should be paid to the points where dampers are attached to the buildings. The slabs are most suitable for the dampers attachment. In this case whole horizontal section of the building is involved and simultaneously it can be assumed to be undeformed in horizontal plane. Otherwise there is the possible negative influence of the local flexibility in the case of the dampers attachment to the walls of the building. Indeed the dampers connection has to constraint the relative motion of the buildings with total masses about $2 \cdot 10^8$ kg.

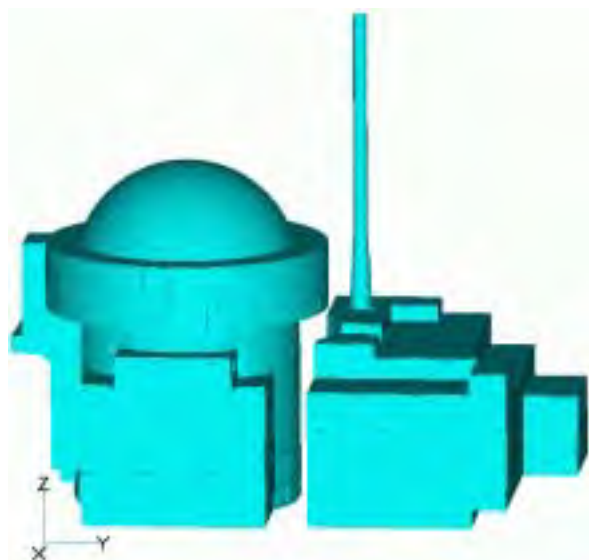

Fig. 24 The Reactor Building and the Special Building

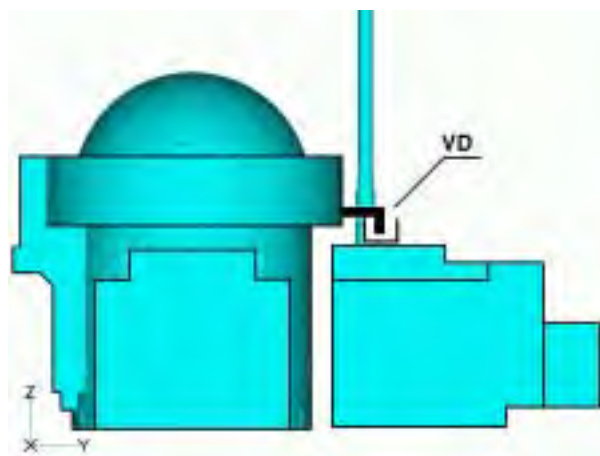

Fig. 25 Possible Installation of VD Dampers

The main mode shapes of the system “Reactor Building – Special Building” are shown in fig.26-29. The typical significant displacements of the buildings about each other are clearly observed. First, the corresponding eigenvalues are essentially different for the different buildings. Thus, the main mode shapes correspond to the rocking of the envelope with frequencies of 3.54 and 3.75 Hz for the reactor building. The special building has the main mode shapes with lateral shear of the slabs with frequencies 7.66 and 8.66 Hz. Second, the frequencies of such mode shapes are in the ordinary frequency range of the earthquake. So these shapes become strong excited during the earthquake. Therefore the general motion of the system “Reactor Building – Special Building” is carried out on these shapes with strong relative displacements. So the dampers connection is supposed to be effective.

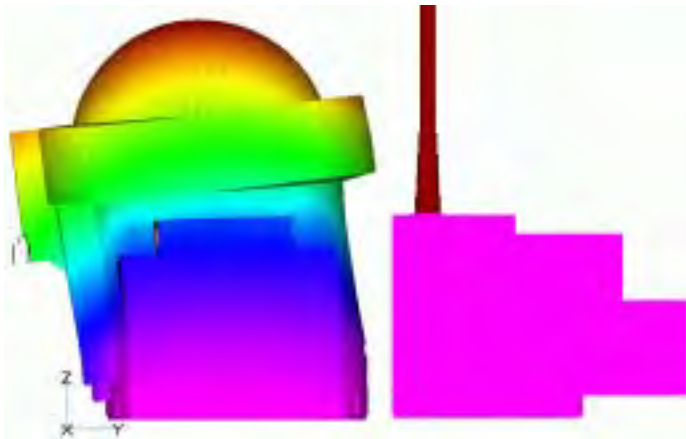

Fig. 26 General Mode Shape of the Reactor Building (3.54 Hz)

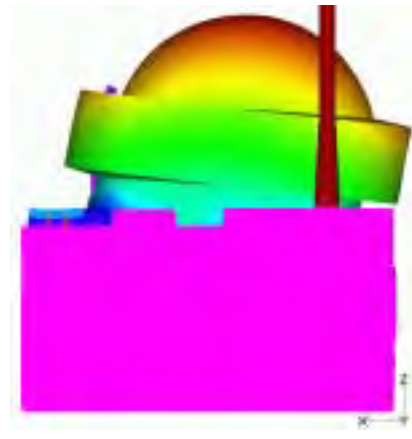

Fig. 27 General Mode Shape of the Reactor Building (3.75 Hz)

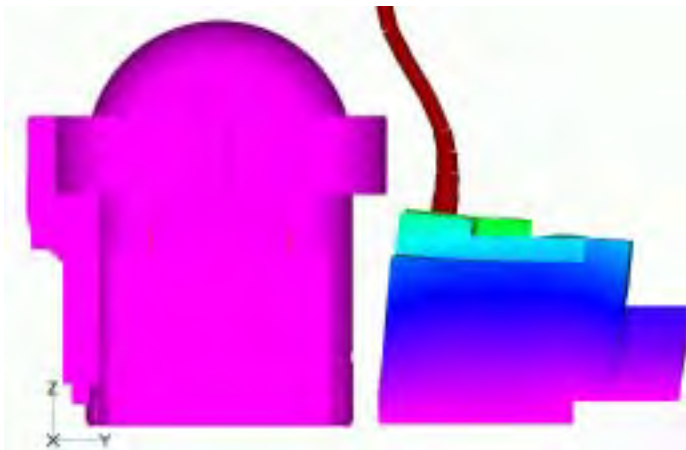

Fig. 28 General Mode Shape of the Special Building (7.66 Hz)

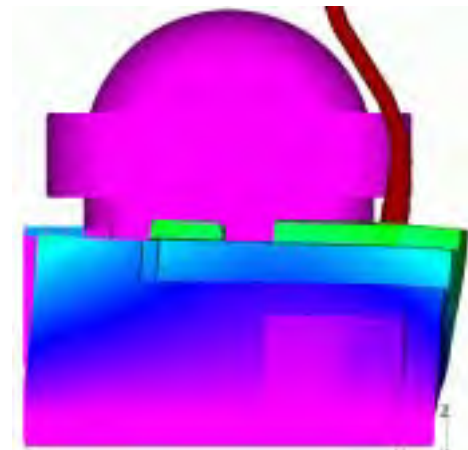

Fig. 29 General Mode Shape of the Special Building (8.66 Hz)

The seismic analysis of the “Reactor Building – Special Building” system is performed to evaluate actual efficiency of the HVD-approach. The connections of 50 and 100 VD dampers are considered. The response spectra are determined for the reactor building and the special building (see in fig. 30-31). The connection of 100 VD dampers can provide the decreasing of maximal Time History acceleration by 20% and maximal spectral acceleration by 40% for the reactor building.

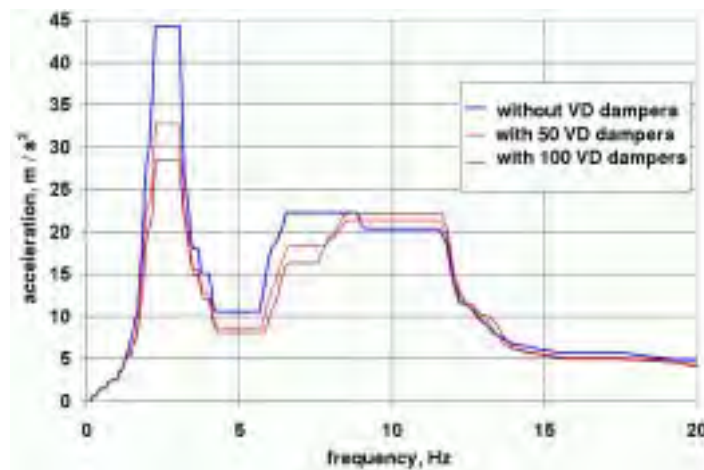

Fig.30 The Seismic Broaden Response Spectra for the Containment Gallery of the Reactor Building (Damping 2%)

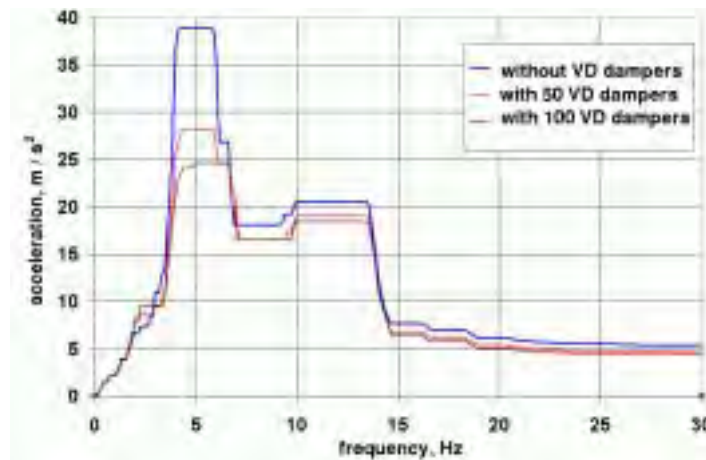

Fig.31 The Seismic Broaden Response Spectra for the Roof of the Special Building (Damping 2%)

5 CONCLUSIONS

An approach for essential reduction of structures' dynamic responses under all kinds of extreme external events was comprehensively investigated and has shown its effectiveness and reliability. It could be recommended for practical application for a new design as well as operating plants.

REFERENCES

- Berkovski A., Kostarev V., Schukin A., Kostov M., Boiadjiev A., Boiadjiev Z., (1997), Seismic analysis of the safety related piping and PCLS of the WWER-440 NPP. Transactions of the 14th SMiRT, Lyon.
- Fomin V., Kostarev V., Reinsch K., (2001), Elimination of Chernobyl NPP Unit 3 Power Output Limitation Associated with High Main. Transactions of the 16th SMiRT, Washington DC.
- Katona T., Ratkai S., Delinic K., Zeitner W., (1994) Reduction of operational vibration of feed-water piping system of VVER-440/213 at PAKS. Proceedings of the 10th ECEE, Vienna.
- Masopust R., (1994), Viscous dampers in applications for pipelines and other components in Czechoslovak nuclear power plants. ASME PVP, Prague.
- Kostarev V., Berkovski A., Kireev O., Vasilyev P., (1994), Application of mathematical model for high viscous damper to dynamic analysis of NPP. Proceedings of 10th ECEE, Vienna.
- Berkovski A., Kostarev V., Schukin A., Vasilyev P., (1995), Seismic Analysis of VVER NPP primary coolant loop with different aseismic devices. Transactions of the 13th SMiRT, Porto Alegre.
- Kostarev V., Petrenko A., Vasilyev P., (2003), A New Method for Essential Reduction of Seismic and External Loads on NPP's Structures, Systems and Components, Transactions of the 17th SMiRT, Prague.